



VOSS-4-UC Enterprise Core Feature Guide

Release 21.1

Feb 08, 2022

Legal Information

Please take careful note of the following legal notices:

- Copyright © 2022 VisionOSS Limited.
All rights reserved.
- VOSS, VisionOSS and VOSS-4-UC are trademarks of VisionOSS Limited.
- No part of this document may be reproduced or transmitted in any form without the prior written permission of VOSS.
- VOSS does not guarantee that this document is technically correct, complete, or that the product is free from minor flaws. VOSS endeavors to ensure that the information contained in this document is correct, whilst every effort is made to ensure the accuracy of such information, VOSS accepts no liability for any loss (however caused) sustained as a result of any error or omission in the same.
- This document is used entirely at the users own risk. VOSS cannot be held responsible or liable for any damage to property, loss of income, and or business disruption arising from the use of this document.
- The product capabilities described in this document and the actual capabilities of the product provided by VOSS are subject to change without notice.
- VOSS reserves the right to publish corrections to this document whenever VOSS deems it necessary.
- All vendor/product names mentioned in this document are registered trademarks and belong to their respective owners. VOSS does not own, nor is related to, these products and vendors. These terms have been included to showcase the potential of the VOSS solution and to simplify the deployment of these products with VOSS should you select to utilize them.

Security Information

This product may contain cryptographic features that may be subject to state and local country laws that govern the import, export, transfer and use of such features. The provision of this software does not imply that third-party authorization to import, export, distribute or use encryption in your particular region has been obtained. By using this product, you agree to comply with all applicable laws and regulations within your region of operation. If you require further assistance, please contact your dedicated VOSS support person.

Contents

1	What's New	1
1.1	Enterprise Core Feature Guide: Release 20.1.1	1
1.2	Enterprise Core Feature Guide: Release 21.1	4
2	Conventions Used in this Guide	7
3	Introduction	8
3.1	Compatibility Matrix	8
3.2	Overview	14
3.3	Getting Started	20
3.4	Search	35
4	Hierarchy Management	50
4.1	Introduction to Hierarchies	50
4.2	Data Access	52
4.3	Navigating the Hierarchy	54
4.4	View the Hierarchy	56
4.5	Site Defaults Doc Templates	56
4.6	Create a Provider	57
4.7	Create a Reseller	59
4.8	Create Intermediate Node	60
4.9	Delete a Hierarchy	60
4.10	Delete Issues and Purges	61
4.11	Set Localization Language at Hierarchy Node	61
5	Customer Management	63
5.1	Create a Customer	63
5.2	Network Device Lists (NDL)	65
5.3	CUCM Group Selection	67
5.4	CUCM Group Counts	69
5.5	Extension Mobility Cross Cluster (EMCC)	69
6	Site Management	75
6.1	Create a Site	75
6.2	Modify Site Defaults	77
7	Apps Management	85
7.1	VOSS Assurance	85
7.2	VOSS Phone Server Management	92
7.3	Conferencing Servers	94
8	Cisco Apps Management	100
8.1	CUCM (Cisco Unified Communications Manager)	100

8.2	SIP Trunks	116
8.3	Route Groups	140
8.4	Route Lists	143
8.5	Route Patterns	147
8.6	Translation Patterns	156
8.7	CUCM Music On Hold (MOH)	165
8.8	CUCM FAC Management	169
8.9	CUC (Cisco Unity Connection)	173
8.10	CER (Cisco Emergency Responder)	176
8.11	CCX (Cisco Contact Center Express)	178
8.12	Prime Collab (Cisco PCA)	179
8.13	IOS	185
8.14	UC Prep Management	212
8.15	Date Time Groups	233
8.16	Locations	234
8.17	Device Pools	237
8.18	CTI Route Points	249
8.19	Time Periods and Schedules	255
9	Microsoft Apps Management	260
9.1	Microsoft Tenant	260
10	LDAP Management	267
10.1	LDAP Integration	267
10.2	Set up an LDAP Server	272
10.3	Set up LDAP for User Synchronization	275
10.4	Synchronize Users from LDAP	277
10.5	Set up LDAP for Authentication Only	277
10.6	View and Update LDAP Authentication Users	280
10.7	Set Up LDAP Custom Role Mappings	280
10.8	Re-provision Synced LDAP Users	282
11	Entitlement	283
11.1	Entitlement	283
11.2	Entitlement Enforcement	286
11.3	Configure and Assign Entitlement Profiles	287
11.4	Add Device Type	288
11.5	Create Device Group	288
11.6	Create an Entitlement Catalog	289
11.7	Create an Entitlement Profile	290
12	User Management	292
12.1	Users	292
12.2	Provisioning	303
12.3	Authentication	306
12.4	Sync and Purge	314
12.5	Manage Filters	324
12.6	Move Users	325
12.7	Admins	332
12.8	Session Timeouts	333
12.9	User Accounts and Passwords	334
12.10	Cisco Unity Connection (CUC) Passwords	339
12.11	Access Profiles	340
12.12	Self Service	343

13 Role Management	347
13.1 Roles	347
13.2 Themes and Layouts	356
13.3 Landing Pages	375
13.4 Credential Policy	382
13.5 Privacy Policy	386
14 Customizations	389
14.1 Introduction to Customizations	389
14.2 Global Settings	389
14.3 Business Admin Portal Profiles	395
14.4 Subscriber Profiles	401
14.5 Configuration Mapping for Phones, DeviceProfiles, and Lines	404
14.6 Dropdown Filters	409
14.7 Line Delete Preferences	412
14.8 Field Display Policies	413
14.9 Configuration Templates	418
14.10 Email	421
15 Dial Plan Management	425
15.1 Introduction	425
15.2 Dialplan Management Menu	426
15.3 Dial Plan Maintenance	428
15.4 Multi-Cluster Dial Plan Maintenance	429
15.5 Dial Plan Input Data and Macros	429
15.6 Dial Plan Models	435
15.7 Dial Plan Model Bulk Loader	471
15.8 Dial Plan Log	471
15.9 Dial Plan Use Checklist	472
16 Microsoft Teams Dial Plan Management	474
16.1 Introduction to Microsoft Teams Dialplan Management	474
16.2 Configure Microsoft Tenant Dialplan	474
17 Microsoft Teams Policies	476
17.1 Introduction to Microsoft Teams Policies	476
18 Number Management	478
18.1 Number Inventory	478
18.2 Number Inventory Overview	479
18.3 Number Inventory List View	482
18.4 Number Status and Usage	482
18.5 Number Range Management	484
18.6 Number Cooling	485
18.7 Number Reservation	487
18.8 Audit Number Inventory	489
19 Unity SIP Integration	491
19.1 Overview	491
19.2 Administration GUI Menus	492
20 Subscriber Management	498
20.1 View and Manage Subscribers	498
20.2 Quick Add Subscriber	517
20.3 Lines	527

20.4	Intercom Lines	530
20.5	Phones	533
20.6	Smart Add Phone	546
20.7	Class of Service	547
20.8	Headsets	548
20.9	Extension Mobility	551
20.10	Subscriber Workflows	553
20.11	Line Reports	564
20.12	Customization Reports	566
20.13	Voicemail	568
20.14	Conferencing	572
20.15	Webex Teams Users	574
20.16	Reassign Services	580
20.17	PLAR (Hotdial)	589
20.18	Hunt Groups	591
20.19	Call Pickup Groups	595
20.20	Contact Center	597
21	Microsoft Subscriber Management	601
21.1	Microsoft Overview	601
21.2	Microsoft Configuration	602
21.3	Onboard and Offboard Microsoft Users	603
21.4	Microsoft Licenses	605
21.5	VOSS-4-UC Configuration and Sync	606
21.6	Microsoft User Move Configuration	609
21.7	Model Filter Criteria	610
21.8	Quick Add Subscriber for Microsoft Users	611
21.9	Overbuild for Microsoft	612
21.10	Sync with Flow Through	614
21.11	Flow Through Provisioning Criteria	615
22	Services	617
22.1	Webex Teams	617
22.2	Auto Attendant (Call Handler)	620
22.3	Manage Greeting Files	630
22.4	Cisco Unity Connection (CUC) Localization	631
23	Overbuild	633
23.1	Overbuild Introduction	633
23.2	Moving Model Instances	636
23.3	Overbuild Site Defaults	637
23.4	Run Overbuild	638
23.5	Overbuild Tool	644
23.6	User Phone Association	644
23.7	Overbuild Analog Gateway	645
23.8	Device Models	645
24	Administration Tools	648
24.1	Import	648
24.2	Bulk Administration	649
24.3	Alerts	661
24.4	Transactions	664
24.5	Northbound Notifications	678
24.6	Schedules	682
24.7	System Settings	684

25 Single Sign On (SSO)	685
25.1 Single Sign On (SSO) Overview	685
25.2 SSO Certificate Management	685
25.3 Configure Single Sign-On for VOSS-4-UC	687
25.4 Configure the System as a SSO Service Provider	690
25.5 Renew Single Sign-On Certificate for VOSS-4-UC	691
25.6 SAML Elements in Assertions	692
26 Data Sync	694
26.1 Data Sync Overview	694
26.2 Default Cache Control Policy	696
26.3 Data Sync Types	697
26.4 Full Sync	700
26.5 Enable a Scheduled Data Sync	700
26.6 Manually Run the Default Data Sync	701
26.7 Controlling a Data Sync with a Model Type List	701
26.8 Create a Targeted Model Type List	702
26.9 Model Instance Filter	703
26.10 Model Instance Filter Examples	707
26.11 View List of Device Models	709
26.12 Create a Custom Data Sync	710
26.13 Unified CM Change Notification Feature Alerts	711
26.14 Change Notification Sync	712
27 Self Service Administration	720
27.1 Self Service Administration: Overview	720
27.2 Self Service Feature Display Policy	720
27.3 Self Service Feature Display Policy Field Reference	721
27.4 End User Access and Authentication	725
27.5 Themes and Branding	725
27.6 Self-Service Login Banner	725
27.7 Personal Phones (Remote Destinations)	726
27.8 Dual Mode Phones - Mobile ID	726
27.9 Voicemail for Self-Service	726
27.10 Links Page	726
28 Self Provisioning	727
28.1 Self-Provisioning Overview	727
28.2 Bottom-Up User Management	727
28.3 Top-Down User Management	728
28.4 Cisco Unified Communications Manager Configuration for Self-Provisioning	728
28.5 Site Configuration for Self-Provisioning	729
28.6 Generate a User's Primary Line	729
28.7 Specify the Primary Line per Subscriber	729
28.8 Add a Self-Provisioning Universal Device Template	730
28.9 Add a Self-Provisioning Universal Line Template	732
28.10 Add a Self-Provisioning User Profile	733
28.11 Set a Default User Profile for a Site	734
28.12 Add Self-Provisioning Line Mask	734
29 Advanced Tools for System Administrators	735
29.1 Custom Variables	735
29.2 Model Report	736
29.3 Menu Diff Tool	737

30 Appendix: Business Admin Portal Configuration	738
30.1 Business Admin Portal Configuration Overview	738
30.2 Custom Icon Names Reference	739
30.3 Custom Business Admin Themes and Branding	754
30.4 Theme Management	755
31 Appendix: Optional Features	765
31.1 Dial Plan Management	765
31.2 Unity SIP Integration	770
31.3 Phone Based Registration	772
31.4 Phone Services	794
Index	801

1. What's New

1.1. Enterprise Core Feature Guide: Release 20.1.1

- EKB-4053: UserOPS Workflows in QuickAddSubscriber and relationSubscriberPhone results in CUCM Purge of existing Phones. See: [Global Settings](#)
- EKB-4170: Make dashboard counters part of the Landing Page config. See: [Landing Pages Field Reference](#)
- EKB-4471: Extension dropdown when adding Voicemail should not show numbers which are already configured for Voicemail. See: [Add Subscribers](#)
- EKB-4471: Extension dropdown when adding Voicemail should not show numbers which are already configured for Voicemail. See: [Voicemail: Overview](#)
- EKB-4663: List View selections are not clearing beyond export/transactions. See: [Selecting Items](#)
- EKB-4666: Implement list operation to refresh status and IP address for a list of phones. See: [Configure Phones](#)
- EKB-4777: Add ex-directory capability to phone services directory. See: [Phone Services Feature Setup](#)
- EKB-5747: Provide control over fields and format of corporate directory display. See: [Phone Services Feature Setup](#)
- EKB-6059: Productize Manage AD LDAP Users Adaptation. See: [Set up an LDAP Server](#)
- EKB-6059: Productize Manage AD LDAP Users Adaptation. See: [Add an Admin User](#)
- EKB-6059: Productize Manage AD LDAP Users Adaptation. See: [Update a User](#)
- EKB-6758: Move Subscriber - Allow Provider Lvl Subscribers to be moved. See: [Move Subscriber](#)
- EKB-6817: Number Inventory Usage tab breaks if multiple Hunt Groups are added with the same DN. See: [Number Status and Usage](#)
- EKB-6817: Number Inventory Usage tab breaks if multiple Hunt Groups are added with the same DN. See: [Line Search](#)
- EKB-7156: Move Subscriber - Phone Type title to Phone Profile. See: [Move Subscriber](#)
- EKB-7163: Move Subscriber - Add ability to select Feature Template once the Phone Config or Line Config Profile has been selected. See: [Move Subscriber](#)
- VOSS-483: Productize Analogue Gateway Adaptation. See: [Set up an Analog Gateway](#)
- VOSS-483: Productize Analogue Gateway Adaptation. See: [Add Port to Analog Gateway](#)
- VOSS-483: Productize Analogue Gateway Adaptation. See: [Overbuild Analog Gateway](#)

- VOSS-551: User Management Overhaul (EKB-7380: Auth update: LDAP and SSO server schema changes) . See: [Set up an LDAP Server](#)
- VOSS-551: User Management Overhaul. See: [Set up LDAP for User Synchronization](#)
- VOSS-551: User Management Overhaul (EKB-4393: Create and share impact assessment document with customers) . See: [User Management Overview](#)
- VOSS-551: User Management Overhaul (EKB-4798: Define and Update new data/User Schema) . See: [View Users](#)
- VOSS-551: User Management Overhaul (EKB-7522: Sync type: Update User schema to include sync type) . See: [View Users](#)
- VOSS-551: User Management Overhaul. See: [Add an Admin User](#)
- VOSS-551: User Management Overhaul. See: [Update a User](#)
- VOSS-551: User Management Overhaul (EKB-4383: Update default RBAC (FDPs, CFTs, MLs, APs) to remove deprecated models) . See: [View a User's Provisioning Status](#)
- VOSS-551: User Management Overhaul (EKB-7380: Auth update: LDAP and SSO server schema changes) . See: [User Authentication Methods](#)
- VOSS-551: User Management Overhaul. See: [User Login Options by Authentication Method and Server Authentication Scope](#)
- VOSS-551: User Management Overhaul. See: [User Management Scenarios](#)
- VOSS-551: User Management Overhaul. See: [User Sync Source](#)
- VOSS-551: User Management Overhaul. See: [User Field Mapping](#)
- VOSS-551: User Management Overhaul (EKB-6537: Support for a mechanism to override authentication method for QAS and Data Sync) . See: [Global Settings](#)
- VOSS-551: User Management Overhaul (EKB-4383: Update default RBAC (FDPs, CFTs, MLs, APs) to remove deprecated models) . See: [Configure Single Sign-On for VOSS-4-UC](#)
- VOSS-551: User Management Overhaul (EKB-7380: Auth update: LDAP and SSO server schema changes) . See: [Configure Single Sign-On for VOSS-4-UC](#)
- VOSS-568: Support for customer-specific SSO URLs. See: [Configure Single Sign-On for VOSS-4-UC](#)
- VOSS-592: Multi-cluster FAC Management. See: [Forced Authorization Codes \(FAC\)](#)
- VOSS-618: Add Enhanced Provider and Customer Menu set for Provider Deployments. See: [Best Practices Menus](#)
- VOSS-620: Provide warning prompts for purge data syncs. See: [Data Sync Types](#)
- VOSS-634: PLACEHOLDER (EKB-3035: Expose Move Subscriber in BAP) . See: [Move Subscriber](#)
- VOSS-651: Number Inventory Improvements. See: [Number Inventory Overview](#)
- VOSS-651: Number Inventory Improvements. See: [Number Status and Usage](#)
- VOSS-651: Number Inventory Improvements. See: [Number Range Management](#)
- VOSS-651: Number Inventory Improvements. See: [Number Cooling](#)
- VOSS-651: Number Inventory Improvements. See: [Number Reservation](#)
- VOSS-660: Add Phone Device to User Tool. See: [Add Device to User](#)
- VOSS-667: Clusterwide Call Park and Directed Call Park. See: [Call Park Management](#)

- VOSS-670: Small Enhancements 20.1.1 (EKB-5233: Ability to see and update the JSON data for a record in the admin portal) . See: [Editing Items](#)
- VOSS-670: Small Enhancements 20.1.1 (EKB-4062: Add custom boolean and string fields to Site Default Doc schema) . See: [Modify Site Defaults](#)
- VOSS-670: Small Enhancements 20.1.1 (EKB-5199: Replace all Href instances for Views in default Menus with the Model Type of View) . See: [Create a Menu Layout](#)
- VOSS-670: Small Enhancements 20.1.1 (EKB-3923: Add Line Delete functionality for cases where Lines are removed from Devices) . See: [Line Delete Preferences](#)
- VOSS-670: Small Enhancements 20.1.1 (EKB-3785: List view summary attributes must honor FDP title overrides) . See: [Field Display Policies](#)
- VOSS-670: Small Enhancements 20.1.1 (EKB-4570: Generic DialPlan: Add DialPlan MultiCluster push Support) . See: [Multi-Cluster Dial Plan Maintenance](#)
- VOSS-670: Small Enhancements 20.1.1 (EKB-4802: Allow system level transactions to be hidden from the transaction log) . See: [Filtering Transactions](#)
- VOSS-670: Small Enhancements 20.1.1 (EKB-4370: Make data sync fail immediately when there is an incorrect MIF) . See: [Model Instance Filter](#)
- VOSS-670: Small Enhancements 20.1.1 (EKB-4868: Create menu diff tool) . See: [Menu Diff Tool](#)
- VOSS-676: New Administration Portal (EKB-3318: New GUI must support the Cache Control Policy for each model type) . See: [Editing Items](#)
- VOSS-687: Provide Extension Mobility Management in BAP Portal (EKB-4500: Add new Device Profile Relation) . See: [Add Subscribers](#)
New topic: Extension Mobility management topic added for Business Admin Portal and VOSS-4-UC.
- VOSS-687: Provide Extension Mobility Management in BAP Portal (EKB-4500: Add new Device Profile Relation) . See: [Extension Mobility](#)
New topic: Extension Mobility management topic added for Business Admin Portal and VOSS-4-UC.
- VOSS-687: Provide Extension Mobility Management in BAP Portal (EKB-4500: Add new Device Profile Relation) . See: [Standalone Extension Mobility](#)
New topic: Extension Mobility management topic added for Business Admin Portal and VOSS-4-UC.
- VOSS-689: Improve usability of Media Termination Point, Transcoder and Conference resources. See: [Media Resources](#)
- VOSS-692: Reset/Restart all phones in a Site. See: [Reset-Restart Site Phones](#)
- VOSS-712: Ability to upload MOH files. See: [Music on Hold \(MOH\) File Management](#)
- VOSS-719: Allow Auto Attendant pilot number to be modifiable and optional (EKB-5821: Callhandler: make Pilot number optional) . See: [Add Call Handler \(Auto Attendant\)](#)
- VOSS-719: Allow Auto Attendant pilot number to be modifiable and optional (EKB-5821: Callhandler: make Pilot number optional) . See: [Modify a Call Handler \(Auto Attendant\)](#)
- VOSS-719: Allow Auto Attendant pilot number to be modifiable and optional (EKB-5720: SysCallhandler: Expose 'Transfer Action' settings (under Transfer Rules tab)) . See: [Modify a Call Handler \(Auto Attendant\)](#)
- VOSS-722: VOSS Phone Server Solution. See: [VOSS Phone Server Overview](#)
- VOSS-722: VOSS Phone Server Solution. See: [Managing VOSS Phone Servers](#)
- VOSS-722: VOSS Phone Server Solution. See: [VOSS Phones](#)

1.2. Enterprise Core Feature Guide: Release 21.1

- EKB-10133: Update “default” Business Admin Portal Profile to Allow Switch to Admin Portal. See: [Business Admin Portal Profiles](#)
- EKB-7436: Implement short term safe-guard against deleting a bulk of users. See: [Data Sync Types](#)
- EKB-7504: Add Microsoft to VOSS Audit File. See: [Create a Customer](#)
- EKB-8338: Add support to specify the managed Site and Subscription for Webex Teams. See: [Webex Teams Licenses](#)
- EKB-8338: Add support to specify the managed Site and Subscription for Webex Teams. See: [Create Webex Teams Service](#)
- EKB-8974: Expose ‘Prepend Digits’ and ‘Wait for Additional Digits Timer’ fields on Auto Attendant Caller Input tab. See: [Modify a Call Handler \(Auto Attendant\)](#)
- EKB-8995: Add support for Single Sign-On. See: [SSO Users and Login](#)
- EKB-8995: Add support for Single Sign-On. See: [Configure Single Sign-On for VOSS-4-UC](#)
- EKB-9104: Flow through provisioning (Zero touch provisioning). See: [Global Settings](#)
- EKB-9104: Flow through provisioning (Zero touch provisioning). See: [Flow Through Provisioning Criteria](#)
- EKB-9773: Generic Dial Plan: Add field “prefixDn” to SIP Trunk Dial Plan Model. See: [Dial Plan Models](#)
- EKB-9816: Enable Mobility for the User automatically when adding a Personal Phone entry or enabling Personal Phone Management. See: [Add Subscribers](#)
- VOSS-693: Small Enhancements 21.1 (EKB-1363: Update / re-design the About / Extended page (for normal and then for TDK)) . See: [Introduction to the Admin Portal User Interface](#)
- VOSS-725: Webex Teams Device / Hybrid Call Management. See: [Global Settings](#)
- VOSS-725: Webex Teams Device / Hybrid Call Management. See: [Email](#)
- VOSS-725: Webex Teams Device / Hybrid Call Management. See: [Quick Add Subscriber Groups Default Model](#)
- VOSS-725: Webex Teams Device / Hybrid Call Management. See: [Webex Teams User CSV files](#)
- VOSS-725: Webex Teams Device / Hybrid Call Management. See: [Create Webex Teams Service](#)
- VOSS-770: New Admin GUI Enhancements 21.1 (EKB-8081: Update Menu Layouts to support Landing Page targets) . See: [Create a Menu Layout](#)
- VOSS-770: New Admin GUI Enhancements 21.1 (EKB-8081: Update Menu Layouts to support Landing Page targets) . See: [Menu Layout Page](#)
- VOSS-770: New Admin GUI Enhancements 21.1 (EKB-8084: Update Menu Layouts to support custom GUI components) . See: [Menu Layout Page](#)
- VOSS-770: New Admin GUI Enhancements 21.1 (EKB-8083: Update Menu Layouts to support conditional items) . See: [Menu Layout Page](#)
- VOSS-770: New Admin GUI Enhancements 21.1 (EKB-8081: Update Menu Layouts to support Landing Page targets) . See: [Custom Components for Menu Layouts and Landing Pages](#)
- VOSS-770: New Admin GUI Enhancements 21.1 (EKB-9491: Landing page links must support custom components) . See: [Custom Components for Menu Layouts and Landing Pages](#)

- VOSS-770: New Admin GUI Enhancements 21.1 (EKB-9491: Landing page links must support custom components) . See: [Create a Landing Page](#)
- VOSS-778: Cisco Phone Status Export Tool (EKB-6877: Create new View + PWF to initiate a filtered phone status export) . See: [Phone Status Export](#)
- VOSS-778: Cisco Phone Status Export Tool (EKB-7863: Export Phone Status - Device Name should be case insensitive) . See: [Phone Status Export](#)
- VOSS-790: Pexip Support. See: [Set Up and Manage the Pexip Server](#)
- VOSS-790: Pexip Support. See: [View a User's Provisioning Status](#)
- VOSS-790: Pexip Support. See: [Global Settings](#)
- VOSS-790: Pexip Support. See: [Add Subscribers](#)
- VOSS-790: Pexip Support. See: [Quick Add Subscriber Groups Default Model](#)
- VOSS-790: Pexip Support. See: [Provision the Pexip Conference Service](#)
- VOSS-790: Pexip Support. See: [Pexip Conferencing Overview](#)
- VOSS-790: Pexip Support. See: [Run Overbuild: Overview](#)
- VOSS-794: Improve transaction log management (EKB-8517: Mechanism to override transaction log level for data sync execution) . See: [Transaction Log Levels](#)
- VOSS-794: Improve transaction log management (EKB-8602: Preserve debug logs for failed transactions) . See: [Transaction Log Levels](#)
- VOSS-794: Improve transaction log management (EKB-9184: Update tooltip for data/DataSync.transaction_log_level to call out default value when value is not set) . See: [Transaction Log Levels](#)
- VOSS-794: Improve transaction log management (EKB-9092: Create a view to allow users below sys hierarchy to change transaction log level) . See: [Manage System Settings](#)
- VOSS-794: Improve transaction log management (EKB-8517: Mechanism to override transaction log level for data sync execution) . See: [Create a Custom Data Sync](#)
- VOSS-795: Multi-vendor Subscriber List and Dashboard (EKB-8087: Make Entitlement Profile services generic) . See: [Entitlement](#)
- VOSS-795: Multi-vendor Subscriber List and Dashboard (EKB-8082: Create Supported Vendor/Service Global Settings) . See: [Global Settings](#)
- VOSS-795: Multi-vendor Subscriber List and Dashboard. See: [View Subscribers](#)
- VOSS-795: Multi-vendor Subscriber List and Dashboard. See: [Multi Vendor Subscribers](#)
- VOSS-835: Extended Webex Teams User and Workplace Management. See: [Global Settings](#)
- VOSS-835: Extended Webex Teams User and Workplace Management. See: [Email](#)
- VOSS-842: Customer and App onboarding automation between VOSS-4-UC and Assurance. See: [VOSS Assurance Monitoring Overview](#)
- VOSS-842: Customer and App onboarding automation between VOSS-4-UC and Assurance. See: [Voss Assurance Arbitrators](#)
- VOSS-842: Customer and App onboarding automation between VOSS-4-UC and Assurance. See: [Probes, Group Names, Profiles and Timings](#)
- VOSS-842: Customer and App onboarding automation between VOSS-4-UC and Assurance. See: [Onboard Voss Assurance Assets](#)

- VOSS-842: Customer and App onboarding automation between VOSS-4-UC and Assurance. See: [Offboard Voss Assurance Assets](#)
- VOSS-842: Customer and App onboarding automation between VOSS-4-UC and Assurance. See: [Set Up Cisco Unified Communications Manager Servers](#)
- VOSS-842: Customer and App onboarding automation between VOSS-4-UC and Assurance. See: [Set up Cisco Unity Connection](#)
- VOSS-847: Support for Microsoft O365 and MS Teams Management. See: [Site Defaults Doc Templates](#)
- VOSS-847: Support for Microsoft O365 and MS Teams Management. See: [Modify Site Defaults](#)
- VOSS-847: Support for Microsoft O365 and MS Teams Management. See: [Microsoft Configuration Setup](#)
- VOSS-847: Support for Microsoft O365 and MS Teams Management. See: [Configure Microsoft Tenant on VOSS-4-UC](#)
- VOSS-847: Support for Microsoft O365 and MS Teams Management. See: [Subscriber Profiles](#)
- VOSS-847: Support for Microsoft O365 and MS Teams Management. See: [Introduction to Microsoft Teams Dialplan Management](#)
- VOSS-847: Support for Microsoft O365 and MS Teams Management. See: [Configure Microsoft Tenant Dialplan](#)
- VOSS-847: Support for Microsoft O365 and MS Teams Management. See: [Introduction to Microsoft Teams Policies](#)
- VOSS-847: Support for Microsoft O365 and MS Teams Management. See: [Microsoft Configuration](#)
- VOSS-847: Support for Microsoft O365 and MS Teams Management. See: [Onboard and Offboard Microsoft Users](#)
- VOSS-847: Support for Microsoft O365 and MS Teams Management. See: [Microsoft Licenses](#)
- VOSS-847: Support for Microsoft O365 and MS Teams Management. See: [VOSS-4-UC Configuration and Sync](#)
- VOSS-847: Support for Microsoft O365 and MS Teams Management. See: [Microsoft User Move Configuration](#)
- VOSS-847: Support for Microsoft O365 and MS Teams Management. See: [Model Filter Criteria](#)
- VOSS-847: Support for Microsoft O365 and MS Teams Management. See: [Sync with Flow Through](#)

2. Conventions Used in this Guide

At the time of writing (21.1) VOSS-4-UC offers two versions of its main user interface:

- Legacy Admin GUI
- Admin Portal

Where the user interface differs for workflow tasks in the system, the documentation refers either to legacy (for the classic Admin GUI), or Admin Portal (for the new GUI).

Note: This does not apply to the Self-Service interface or to the Business Admin Portal.

Formatting Conventions

The table describes formatting conventions in the VOSS-4-UC documentation:

Item	Description
GUI buttons and labels	These are displayed in bold text.
Menu Paths	Menu paths are also shown in bold text, e.g. Customer Management > EMCC > EMCC Group , where '>' is the delimiter between the menu levels. Important Note: The menu paths provided in this guide are the default menu paths shipped with the product. A reseller (or higher) administrator can modify these paths.
Asterisk '*' after field name, e.g. Userid *	Indicates that the field is mandatory.

3. Introduction

3.1. Compatibility Matrix

3.1.1. Application Compatibility Matrix

Note:

- On Cisco UC app versions we list the significant versions; including any SUs supported under that. For exact versions tested see the release notes for the given release. Specific notes are added if there are issues with specific Cisco UC apps versions and VOSS-4-UC versions.
 - On the Cisco UC apps, any new provisioning settings for new features added in a SU will not be visible in VOSS-4-UC unless specific work was done to support them, since AXL API changes are not done in SU releases by Cisco. VOSS Release notes will indicate any SU specific features that have been explicitly supported,
 - If you need a version supported that is not indicated above as supported or planned, contact your VOSS team for further options and if support could be added.
-

VOSS-4-UC 21.1

Vendor	Apps	VOSS-4-UC 21.1	Notes, application specific caveats
VOSS	NBI	3.2.0	
VOSS	VOSS Analytics Dashboard	SP64, SP65	SP65 required for User and Number Inventory Analytics
VOSS	VOSS Assurance Arbitrator	SP23, SP24	
VOSS	VOSS Phone Server	1.0.0	Base release version
Cisco	Cisco UCM	10.0, 10.5, 11.5, 12.5, 14.0	14.0 is latest validated version
Cisco	Cisco Unity Connection	10.0, 10.5, 11.5, 12.5, 14.0	14.0 is latest validated version
Cisco	HCM-F	10.5, 11.5, 12.5, 12.6	12.6.1 is latest validated version
Cisco	UCCX	11.6.2	11.6.2.10000-38 is latest validated version
Cisco	Webex Meetings	Cloud based - so latest	
Cisco	Webex Teams	Cloud based - so latest	
OpenLDAP Microsoft	Directory	OpenLDAP Active Directory	
OpenAM Shibboleth ADFS PingIdentity	SSO	VOSS Tested - OpenAM, Shibboleth Partner integrated - ADFS, PingIdentity	Only Security Assertion Markup Language (SAML) 2.0 is supported.
Microsoft	Microsoft	Skype for Business on-prem, cloud, Microsoft Teams, Office365	
Cisco	Cisco Contact Center	11.x, 12.x	
ServiceNow	ServiceNow	Cloud-based - so latest	
Pexip	Pexip Infinity Conferencing Platform	24.1	Build 55723.0.0 Build date 2020-08-20T15:07:05Z

VOSS-4-UC Adaptations Support

The following Adaptations have been updated to be compatible with VOSS-4-UC 21.1. These Adaptations must be re-installed, using the specific versions listed below, after upgrading to VOSS-4-UC 21.1 if these are currently installed.

VOSS-4-UC Adaptation	Minimum Version	Notes, application specific caveats
GS Cross Site Hunt Group	V1.9_21.1	
GS LinkedSites	V1.27_21.1	
GS Change Line	V0.1_21.1	
GS Group Voicemail	V1.12_21.1	
GS Device OOS	V0.7_21.1	
GS Number Inventory	V0.11_21.1	

VOSS-4-UC 20.1.1

Apps	VOSS-4-UC 20.1.1	Notes, application specific caveats
Cisco UCM	10.0, 10.5, 11.5, 12.5	12.5(1)SU3 is latest validated version
Cisco Unity Connection	10.0, 10.5, 11.5, 12.5	12.5(1)SU2 is latest validated version
HCM-F	10.0, 10.5, 11.5, 12.5, 12.6	12.6.1 is latest validated version
Webex Meetings	Cloud based - so latest	
Webex Teams	Cloud based - so latest	
Directory	OpenLDAP, Active Directory	
SSO	VOSS Tested - OpenAM, Shibboleth Partner integrated - ADFS, PingIdentity	
Microsoft	Skype for Business on-prem, cloud, Microsoft Teams, Office365	
Cisco Contact Center	11.x, 12.x	
ServiceNow	Cloud-based - so latest	

VOSS-4-UC 19.3.4

Apps	VOSS-4-UC 19.3.4	Notes, application specific caveats
Cisco UCM	10.5, 11.5, 12.5	12.5.1su3 is latest validated version
Cisco Unity Connection	10.5, 11.5, 12.5	12.5.1su2 is latest validated version
HCM-F	10.5, 11.5, 12.5, 12.6	12.6.1 is latest validated version
Webex Meetings	Cloud based - so latest	
Webex Teams	Cloud based - so latest	
Directory	OpenLDAP, Active Directory	
SSO	VOSS Tested - OpenAM, Shibboleth Partner integrated - ADFS, PingIdentity	
Microsoft	Skype for Business on-prem, cloud, Microsoft Teams, Office365	
Cisco Contact Center	11.6	
ServiceNow	Cloud-based - so latest	

- For the 19.3.4 PB1 - PB5 Releases, testing was performed using the following Cisco UC apps versions.

UC App	Versions
CUCM	11.5.1 SU9 (11.5.1.21900-40), 12.5.1 SU4 (12.5.1.14900-63)
CUCX	11.5.1 SU9 (11.5.1.21900-40), 12.5.1 SU4 (12.5.1.14900-45)
HCMF	11.5.5 (11.5.5.10000-2), 12.5.1 SU3 (12.5.1.13900-4), 12.6.1 (12.6.1.10000-2)

VOSS-4-UC 19.3.3

Apps	VOSS-4-UC 19.3.3	Notes, application specific caveats
Cisco UCM	10.0, 10.5, 11.5, 12.5	12.5.1su1 is latest validated version
Cisco Unity Connection	10.0, 10.5, 11.5, 12.5	12.5.1su1 is latest validated version
HCM-F	10.0, 10.5, 11.5, 12.5	12.5.1 is latest validated version
Webex Meetings	Cloud based - so latest	
Webex Teams	Cloud based - so latest	
Directory	OpenLDAP, Active Directory	
SSO	VOSS Tested - OpenAM, Shibboleth Partner integrated - ADFS, PingIdentity	
Microsoft	Skype for Business on-prem, cloud, Microsoft Teams, Office365	
Cisco Contact Center	11.6	
ServiceNow	Cloud-based - so latest	

VOSS-4-UC 19.3.2

Apps	VOSS-4-UC 19.3.2	Notes, application specific caveats
Cisco UCM	10.0, 10.5, 11.5, 12.5	12.5.1su1 is latest validated version
Cisco Unity Connection	10.0, 10.5, 11.5, 12.5	12.5.1su1 is latest validated version
HCM-F	10.0, 10.5, 11.5, 12.5	12.5.1 is latest validated version
Webex Meetings	Cloud based - so latest	
Webex Teams	Cloud based - so latest	
Directory	OpenLDAP, Active Directory	
SSO	VOSS Tested - OpenAM, Shibboleth Partner integrated - ADFS, PingIdentity	
Microsoft	Skype for Business on-prem, cloud, Microsoft Teams, Office365	
Cisco Contact Center	11.6	
ServiceNow	Cloud-based - so latest	

3.1.2. Supported Browsers

For this Release, testing was performed using the following browser versions.

Note that older versions of each browser may also be compatible.

OS Browser	Chrome	Edge	Firefox	IE	Safari
Windows 7	80	46	75	N/A	N/A
Windows 10 64 bit	80	46	75	11	N/A
Xubuntu 20.10	87	N/A	N/A	N/A	N/A
Ubuntu 21.04	92	N/A	90	N/A	N/A
Mac OS 11.1	92	N/A	90.0.2	N/A	14.0.2

Internet Explorer 10 and 11 running on Windows 7 require adjustments to the browser's SSL/TLS settings to work:

1. In the browser, choose **Tools > Internet Options**.
2. Click the **Advanced** tab.
3. Scroll to the **Security** heading.
 - For IE 10, locate and select the **Use TLS 1.0** check box, and clear the **Use SSL3** check box if selected.
 - For IE 11, locate and select the **Use TLS 1.0** and **Use TLS 1.2** check boxes.
4. Click **Apply**, then click **OK**.

If TSL1.2 does not work, select the **Use SSL3** and **Use TLS 1.2** check boxes on both IE 10 and IE 11.

3.1.3. VMware Support

For this release, testing was performed using vSphere:

- VMware vCenter Server Appliance version 7.0.0.10600
- VMware ESXi 6.7.0, 13006603
- Client version 7.0.0.10600

VMware version >=5.1 is supported.

VMware feature	Tested this release
HA	No
vMotion	No

3.2. Overview

3.2.1. Welcome to VOSS-4-UC

The primary objective of using VOSS-4-UC is to easily onboard customers and end users with collaboration services. The fulfillment procedures to achieve this objective may involve administrators at the provider, reseller, customer, and site levels of the hierarchy.

This guide provides information about provisioning VOSS-4-UC, including provisioning steps and interactions between VOSS-4-UC and the UC applications of vendors that VOSS-4-UC supports, such as Cisco HCS. This guide also describes user and subscriber management, including LDAP-related move and push operations.

This topic provides a high-level, example task workflow for configuring VOSS-4-UC and onboarding customers and users.

Note:

- This example task overview excludes customization and some optional configuration.
- References to HCM-F and Shared Data Repository (SDR) are only relevant if installed.
- Shared applications are configured at the Provider or Reseller level. Dedicated applications are configured at the Customer level.

Before you begin:

- Any UC Applications to be used for provisioning customer sites and users must be installed and ready.
- For WebEx Cloud, the required licenses and accounts must be available for provisioning.

Task Overview:

1. *Create a Provider.*
2. Optionally, *Create a Reseller*
3. *Create a Customer* at the appropriate Provider or Reseller hierarchy level.
4. *Set Up Cisco Unified Communications Manager Servers*
5. Optionally, configure WebEx and UC applications at the appropriate hierarchy level:
 - a. *Configure Cisco WebEx.*
 - b. *Set up Cisco Unity Connection.*
 - c. *Set Up IM and Presence Service Servers.*
6. *Add a Network Device List (NDL).*
7. *Create a Site.*
8. *Modify Site Defaults.*
9. Configure Northbound Notification if desired as described under “Set Up Northbound Notification”.
10. *Set up an LDAP Server.*
11. *Create a Filter to Move Users.*
12. *Set up LDAP for User Synchronization.*
13. *Move Users.*

14. *Manual User Add to Cisco Unified CM.*
15. Perform end-user Collaboration Service provisioning. See *Add Subscribers.*

CUCDM v8.x Changes

The major change in the configuration between Cisco Unified Communications Domain Manager (CUCDM) from 8.x and VOSS-4-UC is the location of the master data.

In CUCDM 8.x deployments, the master copy of all data was stored in the Shared Data Repository (SDR). Changes to the data were made in CUCDM and then synchronized down to the UC Applications, such as Cisco Unified Communications Manager (CUCM).

In VOSS-4-UC, the source of master data is distributed between VOSS-4-UC and the call manager. A bidirectional sync is used to export and import data from VOSS-4-UC and the applications. This approach enables configuration changes to be made on either the VOSS-4-UC or the UC applications - giving greater flexibility and faster problem resolution.

3.2.2. Unicode Limitations

For VOSS-4-UC, Unicode characters are supported only in the following fields:

- User Information in VOSS-4-UC User Management
- Description
- Contact Information (Address, City, State, Postal Code, Country, Extended Name, External Customer ID, Account ID, and Deal IDs)
- Phone Label

3.2.3. Accessibility

VOSS-4-UC provides a basic level of compliance to W3C accessibility standards by conforming to the core standards required to navigate the Admin Portal. This ensures that VOSS-4-UC content is accessible and more usable in general to people with certain disabilities.

The table describes features to assist people with disabilities, including people who may not be able to use a mouse, or who have visual impairments:

Title display in the browser	When choosing a menu option in the Admin Portal, the selected menu option title is also displayed in the browser tab. This helps users know where they are and also helps them move between pages open in their browser.
Images have alternative text	Images on buttons that perform a function have additional alternative text, which is used by people who cannot see the image. This alternative text is displayed when the mouse pointer hovers over an image. People who are blind and use screen readers can hear the alternative text read out; and people who have turned off images to speed download or save bandwidth can see the alternative text.
All headings given a meaningful hierarchy to ease navigation	Web pages often have sections of information separated by visual headings. Each page typically has at least one heading. When there is more than one heading on a page, the headings have a hierarchy, which makes it easier for the user to navigate to a particular heading and to navigate between headings.
Contrast ratio can be changed	While some people need high contrast, for others, including people with some types of reading disabilities such as dyslexia, bright colors (high luminance) are not readable. They need low luminance. A Chrome plugin can be installed (on the Chrome browser), which allows the user to change the default colors on a page.
Zoom capability	VOSS-4-UC supports zooming without losing any information or functionality.
Keyboard access and alternative visual focus	Many people cannot use a mouse and rely on the keyboard to interact with the Web. People who are blind and some sighted people with mobility impairments rely on the keyboard or on assistive technologies and strategies that rely on keyboard commands, such as voice input. In a browser that supports keyboard navigation with the Tab key (for example, Firefox, IE, Chrome, and Safari): <ol style="list-style-type: none"> 1. Click in the address bar, then put your mouse aside and do not use it. 2. Press the 'Tab' key to move through the elements on the page. 3. To move within elements such as select boxes or menu bars, press the arrow keys. 4. To select a specific item within an element such as a drop-down list, press the Enter key or Spacebar.

3.2.4. Log In to the Admin Portal

The Admin Portal uses the same base address (URL) as the Legacy Admin Portal. The base address is then suffixed with `portal/#/admin`, for example: `https://{hostname}/portal/#/admin`.

Your username and password are the same.

Standard Users

To log in as a standard user:

1. Go to:

- Legacy Admin GUI: `https://{hostname}/login`
- Admin Portal: `https://{hostname}/admin/sso/{Login URI}/login`

2. Enter your username, using either of these formats:

- `{username}@hierarchy`
- `{email address}`
- `{username}`

Important: If logging in with just `{username}`, your username must be unique at the hierarchy level, else login fails. In this case, log in using either `{username}@hierarchy` or `{email address}`. Email address must be unique in the system.

LDAP Users

To log in as an LDAP user:

1. Go to URL: `https://{hostname}/login`

2. Log in, using either `{user ID}[@hierarchy]` or your email address.

- The user ID (`{user ID}`) corresponds to the login attribute name specified in the LDAP network connection, for example, email address, user principal name, `sAMaccountName`. The login attribute name is configured in the authentication attribute of the LDAP device associated with the hierarchy.
- `@hierarchy` is not required when the user ID corresponds to the user's email address (regardless of the login attribute name specified in the LDAP network connection). The hierarchy is in dot notation and corresponds with the hierarchy to which the user belongs. Hierarchy level is the level at which the user is created.

SSO Users

To log in as SSO user:

1. Go to URL:
 - Legacy Admin GUI: `https://{host name}/sso/{SSO login URI}/login`
 - Admin Portal: `https://{host name}/admin/sso/{Login URI}/login`
2. Log in using the relevant SSO identity provider credentials.

Related Topics

- Create a Landing Page in the Core Feature Guide
- SSO Users and Login in the Core Feature Guide
- LDAP Users and Login in the Core Feature Guide

3.2.5. Multi Vendor Support

VOSS-4-UC supports provisioning and management of all unified communications (UC) applications, across multiple UC vendors, including Cisco, Microsoft, and Avaya.

VOSS-4-UC supports single vendor and multi vendor installations.

Vendor	Solution
Cisco	<p>Provides for customized UC app management via the following capabilities:</p> <ul style="list-style-type: none"> • Webex Teams management • Onboarding workflows • Cisco contact center support • Flow-through provisioning • Multiple MACD use cases and workflows • ServiceNow integration • Northbound notification • Generic drivers • Supports complementary systems and applications to work alongside Cisco UC apps
Microsoft	<p>See Microsoft Overview</p> <p>Provides a single, integrated, synchronized interface for managing the existing Microsoft Teams collaboration service, through the web portal, bulk-loading, or the REST API.</p> <ul style="list-style-type: none"> • Connects to adjacent service management platforms • Configurable deployment templates support automated business processes • Workflows for migrating users • End-to-end management of Microsoft Teams, UC and collaboration solutions • License management • Extends Microsoft Teams into enterprise voice • Supports complementary systems and applications to work alongside Microsoft Teams, such as Cisco Call Recording or Contact Center.
Avaya	<p>Manage Avaya enterprise voice, extended into Microsoft Teams.</p>

Related Topics

- Multi Vendor Subscribers in the Core Feature Guide
- Microsoft Overview in the Core Feature Guide

3.3. Getting Started

3.3.1. Introduction to the Admin Portal User Interface

This topic describes the user interface for the VOSS-4-UC user interface.

The Admin Portal Menu Bar

The table describes the information and controls available on the Admin Portal menu bar:

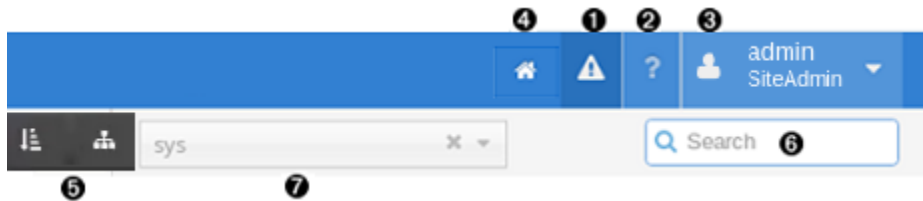

1. Notifications indicator	A notification indicator and menu for accessing the Transaction log and Alerts (if alerts are enabled). A pop-up notification displays when a transaction is done. You can click on the message to inspect transactions. Alert notifications display until all alerts are removed from the list.
2. Help button	A Help button (Help or the icon ?) opens the help in a new browser tab.
3. User profile	The logged in user's username and role, with a drop-down menu for logging out or changing the password. Logout and password change is not available for SSO users. For details about logging out from an identity provider (IdP) initiated session, see the relevant user documentation for the relevant IdP.
4. Landing page	<p>A customizable landing page and a Home navigation button to return to the Home page. See "Create a Landing Page" for details.</p> <ul style="list-style-type: none"> • The system displays a welcome message the first time a user logs in with a new account. • When a non-SSO or non-LDAP user logs in, a system message alerts the user to any failed login attempts. • When SSO or LDAP users log in, the system displays the last successful login time.
5. Hierarchy tree view	A hierarchy tree view and pop-up displays a tree or list of available nodes. See Navigating the Hierarchy
6. Search	A search field
7. Hierarchy element	<p>A hierarchy element displaying the highest hierarchy level. The associated child hierarchy element display in a similar field display box adjacent to the main hierarchy element.</p> <p>If there is more than one level or node at a specific hierarchy, you can search and navigate the hierarchy. See Navigating the Hierarchy.</p>

Forms and Lists

The Admin Portal displays information in forms and lists.

- Detail forms: during input, mandatory fields are highlighted in a red frame.
- List views of details. If the text in a column exceeds the defined column width, it is truncated with an ellipsis (...), except for any column showing the row entry hierarchy.

Slide out notifications

A **Cached** slide-out notification at the top right of the interface displays when the locally cached data of a resource is used.

This slide-out notification can be minimized to a narrow bar on the side of the screen.

Accessibility

To support accessibility, when using keyboard navigation, a black bar is enabled above the toolbar. When the cursor is in the URL box and the Tab key is pressed, this bar is displayed and has three menu items corresponding to three areas of the main user interface:

- **Home screen** - from any form on the interface, return to the main user interface. This is equivalent to the Home button on the menu bar and can for example be accessed by means of a screen reader shortcut.
- **Skip to content** - on the main user interface, move the focus to the landing page menu items. Press <Tab> to move the focus to the first landing page link.
- **Skip to navigation** - on the main user interface, move the focus to the menu bar. The first menu item receives focus.

Sessions and Authentication

Since VOSS-4-UC sessions are cookie based, it is possible to share the same session across different tabs or windows of the same browser. However, it is not possible to have different authentication sessions in different tabs. In other words, login as different users in different browser tabs is not supported.

Button Bar

For certain models, such as Roles or Credential Policy, the list view or detail view of the Admin Portal shows a button bar with a number of controls. The buttons displayed depend on the Access Profile of the user.

Button	Description
Add	When viewing a list, the button opens an Add form to create a new item.
Save	On the Add form, the button is used to save a newly created item. On the detail view, the button is used to save changes made to the specific item.
Delete	From a list, remove an entry or the selected entries.
Cancel	Used to cancel triggered events such as transactions, bulk loads, and so on.
Back	On the detail view, the button returns to the original list page position. The browser's back button also carries out this task.
Help	Open the on-line help page for the current model.
Move	For selected model instances, move them from the current hierarchy to another hierarchy. By default only device models have a Move button. This button is available on list and instance Admin Portal screens. When moving device models, checks are built in to disallow moving a device model instance to a hierarchy node with a different device. For Data Models, Move is allowed by editing the Data Model's definition in the Operations section.

The **Action** menu provides actions applicable to the specific view.

List View Action	Description
Bulk Load File	Only used in Administration Tools > Bulk Load , when bulk loading a preselected file.
Bulk Modify	On the list view of certain items, the button displays a form to enter modifications to any selected list items and carries out a Bulk Modify. This is only available if your administrator has given you the required permissions.
Configuration Template	For a form, create a Configuration Template for a model or carry out a task such as an advanced search.

List View Action	Description
Export	From search results or any list view in the system, it is possible to select the entities required and export them with all attributes. The selected data can be exported to: <ul style="list-style-type: none"> • A JSON file that is archived into .json.zip format for external use. • Excel - an export containing data and Excel columns for all fields as shown in the JSON export format. • Excel(formatted) - an export containing data and Excel columns as arranged by any Field Display Policies that apply.
Export Bulk Load Template	Export a model structure to a MS Excel bulk load file format. The file can be used as a template to bulk load instances of the model. Refer to the Bulk Load topic help.
Field Display Policy	Add a Field Display policy to a selected model. The detail view of a Transaction displays this button to show sub-transactions.
Move	For selected model instances, move them from the current hierarchy to another hierarchy. By default only device models have a Move button, which is available on list and instance Admin Portal screens. When moving device models, checks are built in to disallow moving a device model instance to a hierarchy node with a different device. For Data Models, Move is allowed by editing the Data Model's definition in the Operations section.
Clone	Make a copy of the current item. An option is available to rename the copied item.
Execute	For an executable model such as a Provisioning Workflow, Macro, Wizard or for a script, run the execution.
Import	For supported Network Devices, carry out an import of data from the device.
Export	Export a specific item with all its attributes.
Package	Create a package containing selected search results.
Refresh	Click this button on the Transaction list to refresh the list of transactions. This would for example update the Progress of the transaction.
Replay	Transactions that have failed can, under certain circumstances, be replayed. This means that the transaction is re-submitted with the original request parameters.
Edit and Replay	Available for completed transactions. Similar to the Replay button, but allows you to first make changes to the previously submitted form before the transaction is resubmitted.
Reset Phone	Reset a phone.
Return	Return - From the detail display of a selected instance of a model, select this button to return to the list display of the model instances.
Tag	For a selected model instance, add a tag to it.
Tag Version	For a selected model instance, add a version tag to it.
Test Connection	For instances of models representing connection parameters such as connections to devices, click the button to test the connection.
Visualize	Deprecated.

On-line Help

Press the **Help** button on both the Main Menu button bar as well as the Button bar to open a new browser tab to show on-line help for your system. The new browser tab shows the following menu options:

1. General Help: General help information for the application.
2. Model Detail Help: Model (Item) specific help, for example data/GeneralHelp. This content may vary according to the Field Display Policy that is applied to the item.
3. Model API Help: the API reference for the item.



When the **Help** button (?) is pressed on the Main Menu button bar, only the three menu options are shown. When the **Help** button is pressed on the Button bar, context sensitive help specific to the associated form is also shown.

If a Field on the context sensitive help for an item is marked with an asterisk next to the field name, it is mandatory and must be filled out in order for the subsequent transaction to be successful.

A user's view of the available on-line help depends on hierarchy level, role-based access, and field display policies.





Main Page Controls



The following controls are available on the Admin Portal.

Icon	Description
	These icons are used to access the hierarchy.
	This icon is used to return to the main application page.

Form Controls

The following controls are available from a form.

Icon	Description
	Open another instance of the current form field or open a pop-up screen to add an item.
	Delete the current instance of a field from a form or open a pop-up screen to confirm.
	Move the selected instance on a form down in the order of field entries. In the case where a Position field is available, for example for Lines, the entered value determines the order in the object.
	Move the selected instance on a form up in the order of field entries. In the case where a Position field is available, for example for Lines, the entered value determines the order in the object.

Icon	Description
	On multi-tabbed forms, navigate to the previous or next tab.
	A warning icon, for example if a mandatory field is not filled in.
*	Next to an input control on a form, the asterisk indicates that the field is mandatory.
[Browse]	Next to an input control on a form, a button to open a file selection dialog.
[V]	Drop-down input box. Typing into the box filters the drop-down list choices.

Note: On some parts of the user interface, when adding or deleting items via pop-up screens, clicking the **OK** button typically completes the update; that is, you won't need to also click **Save** on the main form.

About

The **About** menu provides a number of sub-menus:

Version

- Release: Installed product release version.

The version naming convention is:

- new: <YY>.<num>, for example: 19.3 is the 3rd release of 2019.
- legacy: <major>.<minor>.<revision>, where major=YY,minor=num,revision=revision of num.

- Patch Bundle: The installed Patch Bundle (PB) number, if any.
- Build Number: Product build number.
- Release Date: Date when this version was released.
- Deployed Mode: Current deployment mode type, for example:
 - Provider with HCMF
 - Provider Decoupled
 - Enterprise

Patches

If any patches have been installed on the system, these are listed under the **Patches** menu. Details of installed patches are also provided for reference and enquiries, for example:

- **Version:** in this context, the patch version (there can be multiple versions of the same patch).
- **Defect IDs:** VOSS-4-UC internal IDs for reference
- **Models:** any models and model **Instances** added or affected by the patch

Adaptations

If any adaptations are installed on the system, these are listed. Select an adaptation from the list to see more details, for example:

- **Adaptation Tag(s)**: the tags can be used to find all models that are a part of the adaptation, using a search query such as

```
(tag IS <tag1>) or (tag IS <tag2>)
```

where <tag1> and <tag2> are the names of tags.

Note: The search for models is carried out from the user hierarchy and down.

- **Upgrade Risk**: an indication of the impact of an adaptation on an existing system:
 - High: Core changes
 - Medium: Standalone adaptation using core workflows
 - Low: Standalone feature

3.3.2. Dashboards

In the VOSS-4-UC system list views, clicking in a row opens a management dashboard for the resource or service, for example, subscribers or phones. The content of the dashboard panels depend on whether custom interfaces are configured for your system, and on the field display policy applied to your role.

Components display in a panel layout. For example, the Subscribers dashboard may contain panels for:

1. User Details
2. Quick Actions
3. Phones
4. Jabber Devices
5. Extension Mobility
6. Voicemail
7. Single Number Reach
8. Webex Teams

The screenshot displays a user management dashboard with the following panels and callouts:

- 1** User Details panel showing fields: Username (ahmed.calicoat), First Name (Ahmed), Last Name (Calicoat), Email Address (ahmed.calicoat@kittycaat.net), Mobile Number (+447811324632), User Type (VOSS-LDAP Synced), Entitlement Profile (Catnip-Premium-EP), and Located At (CAT-Edinburgh (Site)).
- 2** Quick Actions panel with options: Reset Pin / Password, Add to Hunt Group, Add to Call Pickup Group, Refresh, Logout Phones, Delete All Services, Remove from all Hunt Groups, Remove from all Call Pickup Groups, and Login Phone.
- 3** Phones panel showing a phone icon, Lines (24632, 24732), and actions: Delete, Reset, Generate PRT, and Replace.
- 4** Jabber Devices panel showing two device cards with Lines (24632) and actions: Delete, Reset, Generate PRT, and Replace.
- 5** Extension Mobility panel showing Lines (24632, 24732), Profile Name (ahmed.calicoat-UDP), and Device Type (Cisco 7965), with Edit and Delete actions.
- 6** Voicemail panel showing Voicemail Line (24632), Admin Locked (No), User Locked (No), and Edit, Delete, and Lock Account actions.
- 7** Single Number Reach panel showing Associated Line (24632) and Mobile Number (+447811324632), with Edit and Delete actions.
- 8** Webex Teams panel with a plus sign for adding more items.

The number and type of panels you can add to a dashboard depends on the services and functionality enabled for your system. For example:

- If subscribers have associated headsets, a **Headset** panel may be included, showing details such as vendor, model, firmware version, and serial number.
- Device dashboards provide a **Generate PRT** link for creating and collecting the Problem Report Tool (PRT) file that is uploaded at the Customer support upload URL.

View and Edit Content in the Dashboards

The feature detail dashboard panels provide functionality that allows you to view and work with the feature. For example:

- Editable fields, such as the subscriber **User Details** panel
- Disabled, read-only fields
- Pop-up input forms
- Mandatory fields display a *required* notification (in red text) to indicate that input is required prior to saving a form
- Tooltips in some fields provide additional details
- Links provide access to additional properties, for example, to inspect line details for phones.







Go to Line settings [Line](#) 

Line *

Label

Display

- A Plus icon (+) in a panel indicates that you can add additional devices or services.
- Panels containing multiple properties, such as lines for a phone, contains rows that can be re-ordered, cloned, or deleted.

Lines				
	Line	Label	Display	
	88001006	82010006	82010006	 
	88001007		Brad	 

Related Topics

- Administrator User Interface in the Business Admin Portal Guide

3.3.3. Editing Items

GUI Form

Where user and model permissions allow it, an item can be edited and saved from a GUI form:

- Displayed field names are customizable and provide tooltips according to a Field Display Policy for the model.
- Form GUI Rules control the default field availability and pre-populated values.
- When a form is opened, form details are initially rendered using cached data. While loading the non-cached data, the **Save** button on the button bar is unavailable, and replaced by a 'spinning wheel'. Once the non-cached data has been loaded, the 'spinning wheel disappears and is replaced by the **Save** button.
- A form may also provide an on-line help icon to guide a user in editing it.

JSON Editor

Note: This feature is not available on the Legacy Admin Portal.

If a high level administrator has enabled the **Json Editor** permission in a user's Access Profile (see: [Access Profile Permissions and Operations](#)), then **JSON Edit** button shows on the button bar .

Click this button to open the pop-up JSON editor with the JSON format of the item. The item data can then be edited and saved in the editor using the **Update** button. The changes will update the data on the GUI input form, which can then be saved.

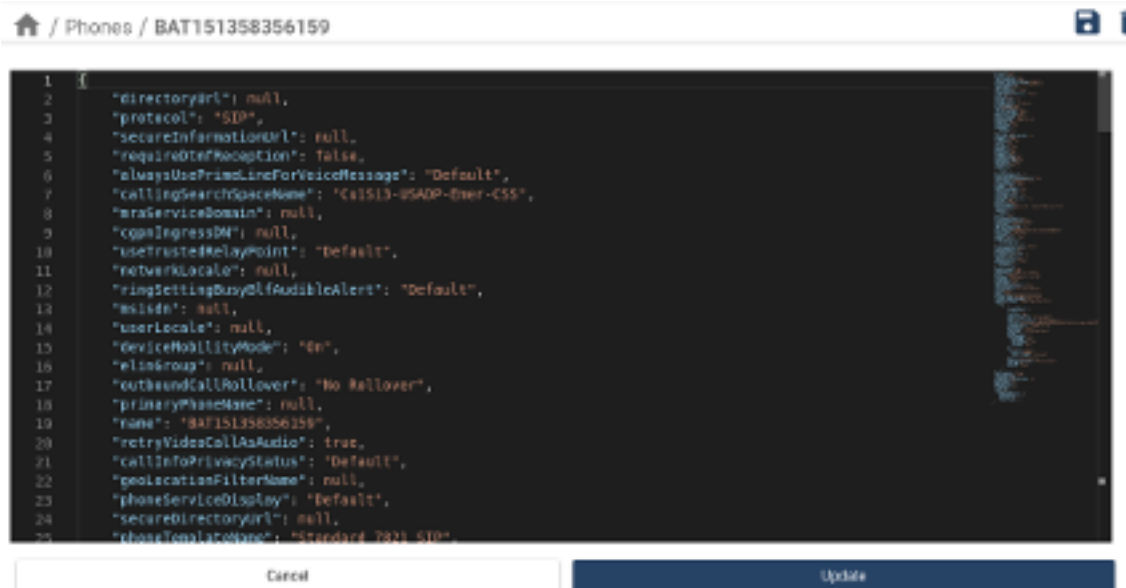

3.3.4. Cloning Items

VOSS-4-UC allows you to make a copy (clone) certain items, such as roles, credential policies, devices, and phones. Cloning provides a quick way to create new items, based on data from the cloned item. A **Clone** action displays on pages in the Admin Portal, where it's possible to create a clone. Clone is not possible in the list views, for example.

The system creates the new cloned item once you click **Save**.

If an item refers to other items, only the current item is cloned, and not the referenced items. For example, when cloning a phone, the device models (Phone and Remote Destination) that are referred to in this item are not cloned.

On the cloned item, you will need to edit the cloned key field(s), such as *Name*, and provide new values to create the new item in the system. If you don't change a key field value, the system displays the following error message: "Error, Duplicate Resource Found."

Create a Clone

This procedure clones an existing item to create a new item.

Perform these steps:

1. Log in to the Admin Portal.
2. Choose the hierarchy level of the item to be cloned.
3. Choose the required item that you want to clone.
4. Click the **Clone** action on the button bar.
5. The page refreshes and the form displays the cloned item.
6. Edit the required details, and click **Save** on the button bar when complete to create the new item.

3.3.5. Selecting Items

Items that have already been created can be deleted or modified as required. This can be performed either on single items or multiple items.

1. For a single item in the list view, click the required single item that you want to delete or modify.
2. For multiple items in the list view, select the check box for each item that you want to delete or modify. If the list view of items spans more than one page, items can be selected on each page as required.
3. Click an action on the button bar, for example **Export**, to carry out the task on the selected items, where relevant.

Note:

- Some actions such as **Export Bulk Load Template**, **Field Display Policy** and **Configuration Template** apply to the *type of item* and are not affected by the item selection.
- Some actions such as **Bulk Modify** depend on whether your administrator has given you the required permissions.

Important Things to Consider when Selecting Items

- Items selected across multiple pages remain selected until the transaction (or export) is complete, at which time all selected items are cleared.
- Items selected while on a specific menu, e.g. Subscribers, are automatically cleared as soon as you select a different menu.
- Items selected across multiple pages are cleared upon filter selection on either the column header or the filter button on the page footer.
- Manually clear selected items on one or more pages by selecting and then clearing the check box located on the left of the *first* column in the header row.

3.3.6. Using Transfer Boxes

Side-by-side transfer boxes are used on various forms in the system, such as Audit Number Inventory, Reskill Agents (Contact Center) and Upload Multiple Files to MOH Clusters.

These two boxes are typically named **Available** and **Selected**, and allow you to select only certain items to process in a specific transaction. For example, you may want to perform an audit on numbers from selected sites only.

A maximum of 200 items can be displayed in the **Available** transfer box. In cases where there are more than 200 available items, VOSS recommends that you use the bulk load functionality and populate a bulk load template with the required entries. You can then load this into VOSS-4-UC using the Bulk Load administration tool. Refer to [Bulk Load Template Export](#) and associated topics for more information.

3.3.7. Bulk Delete and Modify

When more than one item is selected from the list view of items, the selected items can be deleted in bulk by using the **Delete** button on the button bar.

If your administrator has given you the required permissions, you can also bulk modify certain items, for example Roles. Select the check boxes of the items you want to modify and choose the **Bulk Modify** action on the button bar. The input form for the item is opened. Values entered on this form are modified for all selected items when you choose the **Bulk Modify** action.

3.3.8. Working with Lists

Ordering Lists

The list view of items allows for basic ordering by column.

1. Click in the column header of a list. String columns are sorted alphabetically and numeric columns are sorted numerically.
2. Click the column header name or up/down arrow to change the direction or the sort order of the column.

The ordering of a column is shown by the up/down arrow.

Note:

- When sorting, instances with no value for the sort field will sort to the top or bottom of the list, depending on the alphabetical sort direction: ascending or descending.
- Capital letters will sort *before* lower case letters.
- With no filter applied, sort will work on any column in the list view.
- With a filter applied to a single column, sort will work on the filtered column only.
- With a filter applied to more than one column, the sort functionality will not work.
- Leading spaces on a field in the list view are dropped when rendering the list view, so this may affect the sort order.
- The sort order of the **Located At** column will be according to the displayed string value and not the hierarchy path.

Navigating Lists

If a list contains multiple items, page navigation controls at the bottom, center of the screen allow you to:

- scroll to the next/previous page using the right/left arrow respectively.
- scroll to the first or last page of the list as required.
- Go to a specific page by entering the required page number and clicking **Go** (or pressing **Enter**).
- Specify the number of items to display on a page, 25 to 2000.
- If you are unsure of the total number of items in a particular list view, click the **Get total** button or on the last page, the **Update total** button.

For drop-down lists containing more than 200 items, the bottom of the list shows an item called “More choices” that can be selected to show the next items. A subsequent list will also have an item “Previous choices” at the top to navigate back through the list.

Note: Search result lists are limited to a maximum of 1,000 items. A message will show at the bottom of the list pages to indicate this. Use a more specific search query for result lists of more than 1,000 items.

Filtering Lists

VOSS-4-UC Legacy Admin Portal allows you to filter lists in order to view only data based on specific criteria. This includes Transactions and their Sub Transaction and Log lists. For transactions, refer to [Filtering Transactions](#).

A **Filter** button is available next to the **Items/Page** drop-down at the bottom of a list. A filter icon (with the same functionality) is also available next to each column on which you can filter. This is only visible when you mouse hover on the column headings. The **Filter** button on each page defaults to the first column on the page, whereas the filter icon next to the column defaults to that specific column. Click the button (or icon) to open the multi filter dialog.

A filter instance consists of a selected column, a filter operator and a value. Available filter operators are:

- Contains
- Does Not Contain
- Starts With
- Ends With
- Equals
- Not Equal

Note:

- The Contains filter operator and the **Ignore Case** check box = Selected, are applied by default. Add more filter fields as required.
- The sorting of columns (ascending or descending) by clicking column headers while a filter is applied, is only supported for the Starts With operator.
- To filter for rows with no value in a selected Column, choose any Filter Type option, select the **Ignore Case** check box and type `None` in the Value. This works for all list views except Subscriber

- The **Located At** column will only filter on the actual hierarchy name and not the displayed text next to it, for example “site”, “customer”, and so on.
- If access is available to specific models such as Configuration Templates and Macros, a filter will apply to *all* the instances in the hierarchy, since the listing of instances in these models is not restricted to a user’s hierarchy.

Filter instance rows can be added or removed on the dialog to create a filter. The combination of instances create a single filter where *all* instance rows are applied, in other words, in a logical AND.

String values are case sensitive, unless the **Ignore Case** check box is selected. All the filter operators apply to strings.

For Boolean values in a column, the filter is applied using any filter operators, but only with values “True”, “true”, “False” or “false”.

Number values in a column also use Equals and Not Equal filter operators. For floating point values, at least one decimal digit is required for filtering, for example 2.0. Filtering can be applied to values with decimal values up to 7 decimals. For example, consider a list of values:

```
2.2000001
2.0000001
2.0000001
```

The filter: Not Equal to 2.00000001 displays only one value (2.2000001), because the filter value has more than 7 decimals.

To apply the filter, press **Enter** or click the **Apply** button. This will hide the active filter dialog and show the filtered list. An **X** button shows next to the active **Filter** button.

For model lists, actions can then for example be carried out on a selection of items from the filtered list. The filter remains active until it is removed or until the user session on the Legacy Admin Portal ends.

For all types of filters, the **Filter** button funnel icon is black when a filter is active, and white when no filter is present.

A funnel icon also shows in the list header to indicate that a filter is active and that the list is currently filtered. An **X** button shows next to the active **Filter** button.

If a filter is active on a list, click the **Filter** button to display the multi filter dialog again.

Close an unapplied filter dialog by clicking outside it. Unapplied filters are lost when the dialog is closed.

A filter remains active even when navigating away from the list. More than one filter can therefore be active on lists available in a session on the Legacy Admin Portal.

Remove an active filter by clicking the **Remove** button on the multi filter dialog or by clicking the **X** button next to the active **Filter** button.

Important: Standard list view filters on model types will be removed and replaced by any Configurable Filters on landing page links or menu items for the corresponding model type when these are used. See: [Configurable Filters in Menus and Landing Pages](#).

A filter example is shown in the figure below.

Action	Status	Transaction	Submitted Time	Detail
Create Site Defaults Doc	Success	Link	November 28, 9:37:12 AM	LOC002
Create Hcmf Customer Location	Success	Link	November 28, 9:37:08 AM	CustomerLocation
Create Base Site DOM	Success	Link	November 28, 9:37:03 AM	LOC002
Create Hcs Network Device List Reference REL	Success	Link	November 28, 9:36:54 AM	LOC002
Create User	Success	Link	November 28, 9:36:48 AM	LOC002Admin
Create Hcs Admin User DAT	Success	Link	November 28, 9:36:48 AM	
Create Hcs Role DAT	Success	Link	November 28, 9:36:41 AM	LOC002SelfService
Create Role	Success	Link	November 28, 9:36:39 AM	LOC002SelfService
Create Hcs Role DAT	Success	Link	November 28, 9:36:36 AM	LOC002SiteOper
Create Role	Success	Link	November 28, 9:36:33 AM	LOC002SiteOper

Filtering Lists from the Filter Control

From a list view, select the filter control to show a form to enter filter conditions:

1. Select a field from the list view from **Select Field**.
2. Select a filter condition to apply to the field from the **Select Condition**.
3. Enter a value in the **Enter Filter Value** as a value of the condition.
You can choose to ignore the case of your filter value.
4. Choose **Add Filter Condition**. Filters are added below the input boxes.
5. When all filters are added, click **Filter**.

The list view displays the filtered list and the headers show:

- the number of result rows matching the filter
- the defined filter as a text link that can be opened to modify the filter if needed
- the filter values in the filter header row of the selected fields columns

3.4. Search

3.4.1. Search: Overview

A search input box is always available to allow the user to search quickly for items. The default search context is across all components on the system that the user has permission to view as specified in their Access Profile, with the caveats on number of items, relations and device models listed below.

For a simple, entered string, the search matches the start of the text of a component.

Note:

- Search result lists are limited to a maximum of 1,000 items. A message will show at the bottom of the list pages to indicate this. Use a more specific search query for result lists of more than 1,000 items.
- Simple search strings will match values in data and device models (relations instances will not be returned). To search the relation model instances, specify the model as a part of the query - refer to the search syntax.

- For a number of models, case insensitive searching on field names are supported. For a the list of models and supported text cases, see [Case Insensitive Search Fields](#).
- While all models can be searched for by using their summary attributes, a number of models can also be searched on by a subset of their attributes. See: [Searchable Fields](#).
- Selecting a data or device model instance returned in a search will display the full model details, in other words, without a Field Display Policy applied.

Carry Out a Search

1. Choose a hierarchy from which to carry out the search.
2. Enter a search string (using the search syntax) in the **Search** text box. By default, sub-string matches of the string will be searched for. This means that a search for “Site” will also show “Site2” in the result list.
3. Press **Enter** on the keyboard. Search results are shown in the list view.

Perform an Action on the Search Result Set

To perform an action on the search result set:

Click an entry in the list view to open the result instance, or select a specific check box and click one of the buttons on the button bar, such as **Delete**, or select one of the options from the **Action** drop-down, such as **Export** or **Tag** to carry out the associated task. The buttons and options available are dependent on the access profile of the user performing the search.

To select multiple entries, select all the relevant check boxes.

3.4.2. Search Syntax

The query input box can be used to construct a search query. This section describes the syntax of a search query.

Search queries can contain:

- Model type and model name references
- Model attribute and nested model attribute references
- Key words
- Brackets for grouping
- Query string to search for

Valid query string characters are:

- alphanumeric characters
- `!@#%&*_-=+<,.>/?|[]{}~``
- to search for single quote in a string, wrap the string in double quotes
- to search for double quote in a string, wrap the string in single quotes

Since a search query is carried out on models, the specific model type and model name can be specified in the query.

The query format is indicated below:

`type/name` is the syntax for a full reference to a model type (for example relation, data, or device) and model name (for example Countries).

A number of keywords are available to construct a search query.

Keyword Types

Three types of keywords are available:

- Specification - WITH
- Matching - IS, LIKE
- Grouping - AND, OR

Keyword	Description and Examples
WITH	<p>Restricts the search to look for only specific data types. In the example below we have specified the data type Countries and so only countries will be returned.</p> <pre>((data/Countries WITH country_name LIKE Kingdom) AND (data/Countries WITH country_name LIKE Unite))</pre>
IS	<p>For a result to be returned the data attribute must match exactly the 'input'. In the example below the 'input' is Spain and only a Country with the attribute country_name Spain will be returned. If 'North Spain and South Spain existed they would not be returned. In the example below we have specified the data type Countries and so only countries will be returned. If we had not specified a data type then the search would cover all data types looking for an attribute country_name.</p> <pre>country_name IS Spain data/Countries WITH country_name IS Spain</pre> <p>Another example with a model tag as reference:</p> <pre>tag IS "featurea"</pre>
CONTAINS	<p>Matching is done by substring and is the default parameter. For a result to be returned, the data attribute must contain 'input'. In the example below, the 'input' is 'Sw' and the search would find both 'Sweden' and 'Switzerland'.</p> <pre>data/Countries WITH country_name CONTAINS Sw</pre>

Keyword	Description and Examples
LIKE	<p>Matching is done by fuzzy search. For a result to be returned, the data attribute must nearly match 'input'. In the example below, the 'input' is 'swe' and the search would find both 'Sweden' and 'Switzerland'.</p> <pre>data/Countries WITH country_name LIKE swe</pre>
AND	<p>This grouping term allows you to combine different searches and only finds a result where both conditions are met. The example below the search would find 'United Kingdom' but not the 'Kingdom of Bhutan' as in this case the second condition (LIKE Unite) is not true.</p> <pre>((data/Countries WITH country_name LIKE Kingdom) AND (data/Countries WITH country_name LIKE Unite))</pre>
OR	<p>This grouping term allows you to combine different searches and matches a result where any one or both of the conditions are met. The example search below would find 'United Kingdom', 'United States' and 'Kingdom of Bhutan'.</p> <pre>((data/Countries WITH country_name LIKE Kingdom) OR (data/Countries WITH country_name LIKE Unite))</pre>

Search Syntax Diagrams

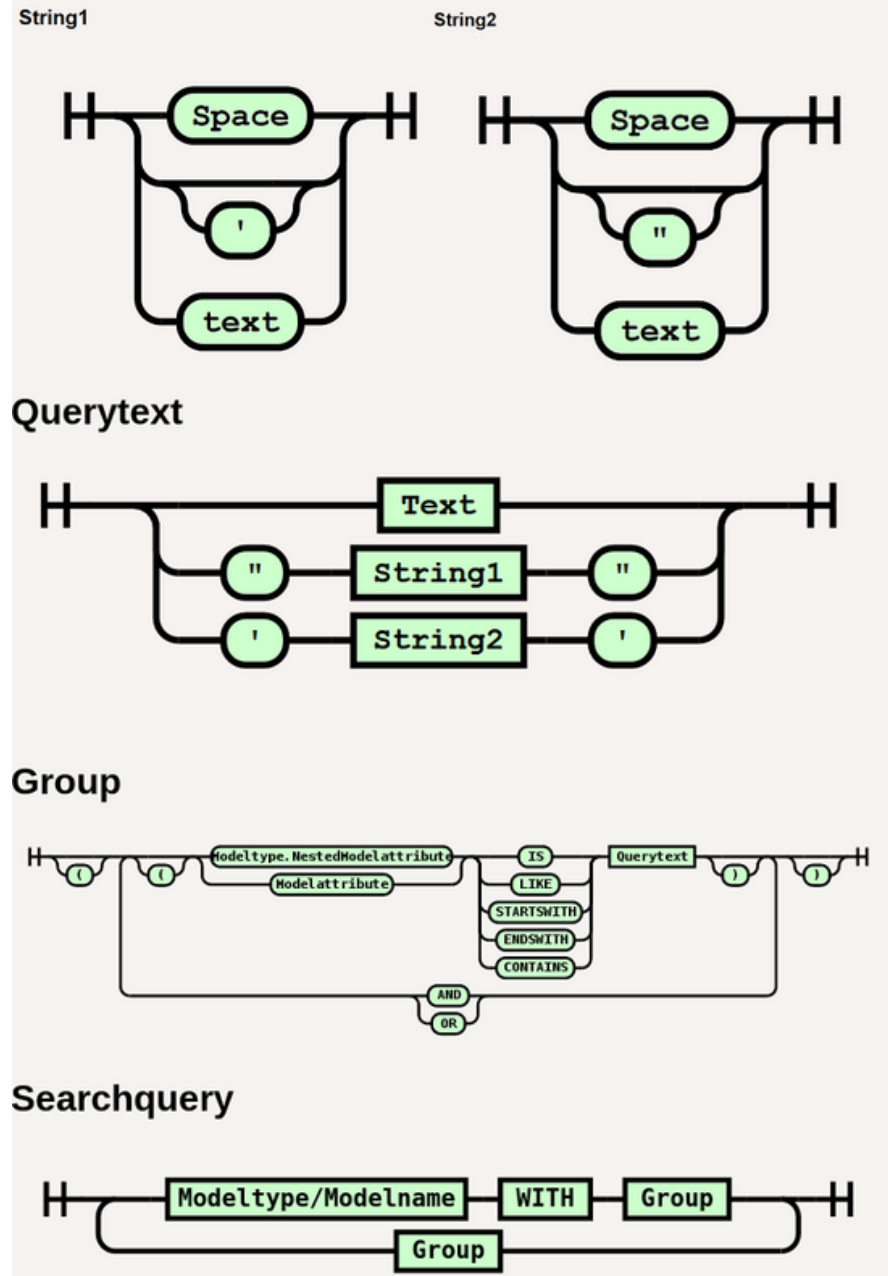

Search Examples

Where the attribute of a model is nested in an object, the reference to the attribute in the search query requires a model type specification.

For example, for a model `data/User` with an attribute in a nested object called `account_information`, the query should take the model type (`data`) specifier:

```
data/User WITH data.account_information.credential_policy IS Default
```

The following query *will not* yield results:

```
data/User WITH account_information.credential_policy IS Default
```

Brackets should be used in a query with matching and grouping operators. In a query containing no model references, brackets are evaluated first. The order of bracket evaluation is inner to outer brackets.

Example Queries (line breaks added):

```
((data/Countries WITH pstn_access_prefix IS 9) AND
 (data/Countries WITH emergency__access_prefix IS 112))
OR (data/Countries WITH international_access_prefix IS 00))
```

Search String Format

The string to search for can be specified with the following properties:

Multi-word and quotes Enclose in quotes. Single- and double quotes are supported. Example: 'United States'

When single word or multi-word values contain a single or double quote, the string needs to be enclosed in double or single quotes respectively, for example: "L'Amour".

Case sensitivity Use the appropriate operator (LIKE)

In a query containing model references, brackets and grouping keywords, the query is evaluated in the order.

Order	Element	Description
1	WITH	Model reference is evaluated first.
2	brackets	Brackets evaluate before grouping keywords.
3	AND	AND grouping evaluates before OR grouping.
4	OR	Evaluates last.

A number of attributes from the meta data of a model can also be searched:

- `__device_pkid`: if a device pkid is known, then for example:
`device/cucm/Line WITH __device_pkid IS 55c32b59a6165451e04f392a`
- `pkid`: if a pkid is known, then for example:
`data/CallManager WITH pkid IS 55c32b59a6165451e04f392a`
- `tags` (can also use "tag"): if the tag name is known, then for example:

```
((data/FieldDisplayPolicy WITH tag IS feature_tag_add_customer) AND
 (data/FieldDisplayPolicy WITH tags IS applicationendtoend))
```

Note: Only tags that are written in lower case are searchable.

3.4.3. Searchable Fields

All models can be searched for by using their summary attributes. In addition, a number of models can also be searched on by a subset of their attributes.

Below is the list of these models and their searchable fields:

- device/cuc/AlternateExtension
 - DtmfAccessId
 - IdIndex
 - UserObjectId
 - ObjectId
- device/cuc/Callhandler
 - templateObjectId
 - DisplayName
 - ObjectId
 - DtmfAccessId
 - Language
 - TimeZone
 - VoiceName
 - RecipientSubscriberObjectId
- device/cuc/CallhandlerMenuEntry
 - DisplayName
 - CallHandlerObjectId
 - TouchtoneKey
 - TransferType
 - TransferNumber
 - Action
- device/cuc/CallhandlerOwner
 - TargetHandlerObjectId
 - ObjectId
- device/cuc/CallhandlerTransferOption
 - URI
 - TransferOptionType
 - CallHandlerObjectId
 - TransferOptionType

- Extension
- Action
- TransferType
- device/cuc/Greeting
 - GreetingType
 - CallHandlerObjectId
- device/cuc/HtmlDevice
 - DeviceName
 - DisplayName
 - SubscriberObjectId
 - ObjectId
 - SmtAddress
 - CallbackNumber
- device/cuc/PagerDevice
 - DeviceName
 - PhoneNumber
 - DisplayName
 - ObjectId
 - SubscriberObjectId
- device/cuc/PhoneDevice
 - DeviceName
 - PhoneNumber
 - DisplayName
 - ObjectId
 - SubscriberObjectId
- device/cuc/SmsDevice
 - DeviceName
 - DisplayName
 - SubscriberObjectId
 - ObjectId
 - SmppProviderObjectId
 - RecipientAddress
 - SenderAddress
- device/cuc/SmtDevice
 - DeviceName
 - PhoneNumber

- DisplayName
- SubscriberObjectId
- ObjectId
- SmtAddress
- device/cuc/User
 - Alias
 - FirstName
 - LastName
 - DtmfAccessId
 - EmailAddress
 - TimeZone
 - templateAlias
 - ObjectId
 - MailboxStoreObjectId
 - CallHandlerObjectId
- device/cuc/UserPassword
 - Alias
 - UserObjectId
 - CredentialType
- device/cuc/UserPin
 - Alias
 - UserObjectId
 - CredentialType
- device/cucm/DeviceProfile
 - class
 - description
 - lines
 - loginUserId
 - name
 - phoneTemplateName
 - product
 - protocol
 - services
 - softkeyTemplateName
- device/cucm/EnterpriseFeatureAccessConfiguration
 - pattern

- routePartitionName
- device/cucm/Line
 - alertingName
 - description
 - asciiAlertingName
 - pattern
 - routePartitionName
 - shareLineAppearanceCssName
 - callPickupGroupName
 - presenceGroupName
 - usage
- device/cucm/Phone
 - callingSearchSpaceName
 - class
 - description
 - devicePoolName
 - digestUser
 - lines
 - locationName
 - name
 - ownerUserName
 - phoneTemplateName
 - presenceGroupName
 - primaryPhoneName
 - product
 - protocol
 - subscribeCallingSearchSpaceName
 - ip_address
 - status
- device/cucm/PhoneButtonTemplate
 - name
 - basePhoneTemplateName
- device/cucm/PhoneSecurityProfile
 - description
 - name
 - protocol

- phoneType
- device/cucm/PhoneType
 - PhoneType
 - ProtocolTemplates
 - PhoneNamePrefix
- device/cucm/RemoteDestination
 - destination
 - name
 - ownerUserId
 - remoteDestinationProfileName
 - dualModeDeviceName
 - ctiRemoteDeviceName
- device/cucm/RemoteDestinationProfile
 - devicePoolName
 - description
 - class
 - lines
 - name
 - primaryPhoneName
 - product
 - protocol
 - userId
- device/cucm/RoutePattern
 - routePartitionName
 - pattern
 - destination
 - description
- device/cucm/RoutePlan
 - dnOrPattern
 - partition
- device/cucm/TransPattern
 - pattern
 - routePartitionName
 - calledPartyTransformationMask
- device/cucm/User
 - userid

- mailid
- firstName
- lastName
- associatedDevices.device
- lineAppearanceAssociationForPresencesdepartment
- lastName
- primaryDevice
- primaryExtension
- phoneProfiles
- status

3.4.4. Case Insensitive Search Fields

Case insensitive searches and macro lookups can be carried out for certain model types and fields.

Below is the list of these models and their field name case variants:

- data/NormalizedUser
 - username
 - mail
- data/User
 - username
 - email
- device/avayaes/Agent
 - Name
 - name
- device/avayaex/User
 - LoginID
 - loginid
 - FirstName
 - firstname
 - LastName
 - lastname
 - EMail
 - email
- device/avayaol/User
 - FirstName
 - firstname
 - LastName

- lastname
- UserName
- username
- device/avayasm/User
 - loginName
 - loginname
 - userName
 - username
 - givenName
 - givenname
 - middleName
 - middlename
 - surname
- device/azureadonlie/MsolUser
 - UserPrincipalName
 - userprincipalname
- device/cuc/Callhandler
 - DisplayName
 - displayname
- device/cuc/GlobalUser
 - alias
 - Alias
- device/cuc/User
 - alias
 - Alias
 - emailAddress
 - EmailAddress
- device/cuc/UserPassword
 - alias
 - Alias
- device/cuc/UserPin
 - alias
 - Alias
- device/cucm/Phone
 - ownerUserName
 - ownerusername

- device/cucm/RemoteDestination
 - ownerUserId
 - owneruserid
 - name
 - dualModeDeviceName
 - remoteDestinationProfileName
 - ctiRemoteDeviceName
- device/cucm/RemoteDestinationProfile
 - userid
 - userIdname
- device/cucm/TodAccess
 - ownerIdName
 - owneridname
- device/cucm/User
 - userid
 - mailid
- device/ldap/user
 - samaccountname
 - sAMAccountName
- device/msgraph/MsolUser
 - UserPrincipalName
 - userprincipalname
- device/msteamsonline/CsOnlineUser
 - UserPrincipalName
 - userprincipalname
- device/pexip/Conference
 - primary_owner_email_address
- device/spark/User
 - email
- relation/HcsAdminUserREL
 - hcsUname
- relation/HcsUserREL
 - username
- relation/SparkUser
 - email
- relation/Subscriber

- userid
- mailid
- relation/SystemUser
 - username
- relation/UccxAgent
 - userID
- relation/User
 - username
 - email
- relation/Voicemail
 - Alias

4. Hierarchy Management

4.1. Introduction to Hierarchies

Configurable hierarchy nodes in VOSS-4-UC allow the partitioning of data in a multi-tenant system.

VOSS-4-UC allows you to model the hierarchical nature of various types of businesses via hierarchy nodes, hierarchy node types, and hierarchy rules.

Hierarchy rules can be applied to various models in the system. An example of a hierarchy rule is that sites can only be created under a customer.

Hierarchy nodes and node types may include:

- provider
- reseller
- customers
- shared buildings
- sites
- divisions
- branches

The hierarchy structure allows you to manage the allocation of infrastructure (such as network device lists), users, and other entities.

The diagram illustrates an example of a system that hosts two managed service providers: *Varidion* and *VS-OPS*.

- *VS-OPS* hosts two customers: *VS-Corp* and *GenCorp*
- *VS-CORP* operates from these locations: Boston, Brooklyn, Chicago and New York.

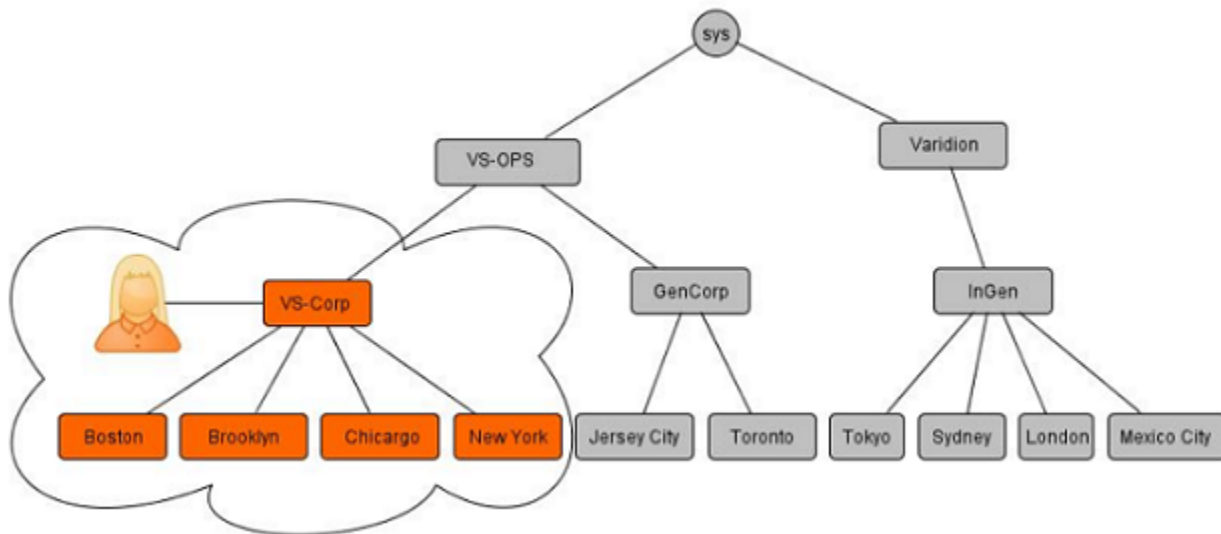

The ability to create administrators with different roles for different types of hierarchy nodes allows devolved administration. For example:

- An administrator is responsible for the setup of the overall system.
- Provider administrators own and manage infrastructure and define services available to resellers.
- Resellers offer the infrastructure and services to customers or enterprises.
- Customers and enterprises are grouped into various groupings.
- Groupings such as divisions or branches belong to customers.
- Physical locations hold users and phones.
- End users consume services and manage their own configurable settings.

A flexible hierarchy allows you to:

- Define as many levels as you need
- Create hierarchy node instances of different types
- Define the required business rules

4.1.1. Parent-Child Relationships

All entities in the system reside at a specific hierarchy and the data displayed is within the scope of the specified hierarchy. This means that every entity in the system - including users, device models and network components - has a parent hierarchy defined. A user is for example provisioned with a specific hierarchy node in a parent-child relationship. User names must be unique within a specific hierarchy.

Related Topics

- Network Device Lists in the Core Feature Guide
- VOSS-4-UC Configuration and Sync in the Core Feature Guide

4.2. Data Access

VOSS-4-UC secures access to data with the concepts of data partitioning via hierarchies, and user roles.

Data Partitioning and Hierarchies

Data partitioning by way of hierarchies means that an administrator user is only allowed to view and perform operations on entity instances that are provisioned at the parent hierarchy of the hierarchy where they have access. Access to resources is thus based on the user's parent hierarchy. This restriction is enforced in API middleware for every requested operation. Partitioning is enforced across the various system interfaces, for example loaders, API, and the Admin Portal. This means that an administrator user for customer "VS-Corp" cannot view or act on data at customer "GenCorp". The "VS-Corp" administrator can only view and act on entities assigned to "VS-Corp" or its child hierarchy levels (sites).

Note: When an administrator navigates to a particular hierarchy they may have read-only access to model instances created at a higher level of the hierarchy. For example, a provider administrator's view of the list of menu layouts may show instances created *above* the provider's hierarchy. In this case, the administrator requires read-only access in order to have the ability to clone a field display policy at a lower level of the hierarchy. This administrator will not be able to edit the model instance created at the higher level of the hierarchy. However, a provider administrator viewing the list of model instances below the provider level is able to edit model instances created at the provider hierarchy.

When the model is designed, the following setting is enabled: **Visible at Lower Hierarchy**

This setting is available for Data, Domain, and Relation definitions. For Relations, the setting overrides the setting in any related models. See the table below.

User Roles, Access Profiles, and Data Security

Access profiles define the read and write permissions assigned to user roles. The access profile defines how the user can interact with specific system entities. Permissions include details of each entity type in the system, as well as the relevant privileges related to that entity type. See [Role-based Access](#).

- Hierarchy - defines the specific instances of the various entities that the user can interact with
- User's role and access profile - determines the permitted operations that can be performed on these instances.

The table describes models with **Visible at Lower Hierarchy** set to *true*:

Name	Model Type
AccessProfile	data/DataModel
Adaptation	data/DataModel

continues on next page

Table 1 – continued from previous page

Name	Model Type
AdaptationLog	data/DataModel
BulkAdminDataRefreshPerHierarchy	data/DataModel
BulkAdminFullDataRefresh	data/DataModel
BulkAdminScheduleDataRefresh	data/DataModel
Bundle	data/DataModel
Bundle	data/Relation
ConfigurationTemplate	data/DataModel
Countries	data/DataModel
CredentialPolicy	data/DataModel
FeatureConfigProfile	data/DataModel
FieldDisplayPolicy	data/DataModel
HcsCommandBuilderDAT	data/DataModel
HcsDeviceGroupDAT	data/DataModel
HcsDeviceTypeDAT	data/DataModel
HcsDpDialPlanSchemaDAT	data/DataModel
HcsDpDialPlanSchemaGroupDAT	data/DataModel
HcsLocalizedStringDat	data/DataModel
HcsMovePhoneCustomizationsDAT	data/DataModel
HcsMoveSubCustomizationsDAT	data/DataModel
HcsPrimeCollabREL	data/Relation
LandingPage	data/DataModel
Macro	data/DataModel
MenuLayout	data/DataModel
Patch	data/DataModel
ProvisioningWorkflow	data/DataModel
QuickAddGroups	data/DataModel
Role	data/DataModel
SelfServiceFeatureDisplayPolicy	data/DataModel
SelfServiceLinks	data/DataModel
SelfServiceTranslation	data/DataModel
Theme	data/DataModel

4.3. Navigating the Hierarchy

A number of Admin Portal features are available to quickly and effectively navigate to a required hierarchy level and to set the context for various actions in the system at that level.

- Bread crumbs

Navigate through the hierarchy by using the hierarchy bar at the top of the page. Each hierarchy node selection from a drop-down list on the bar that is a parent node may enable a lower level drop-down list, creating a “bread crumbs” list of the hierarchy path. Long lists show a scroll bar in the drop-down lists.

If more than 2 items are in the drop-down list, a search box shows in the list input box. A *case-insensitive* search can be carried out with a string that is *contained* in the name.

- Hierarchy Tree view

Use the tree view icon on the hierarchy bar at the top of the page to show a tree view of the entire hierarchy. Choose a hierarchy node on the tree to easily navigate to that node.

The nodes in the tree also show its hierarchy type: Provider, Reseller, Customer, Site.

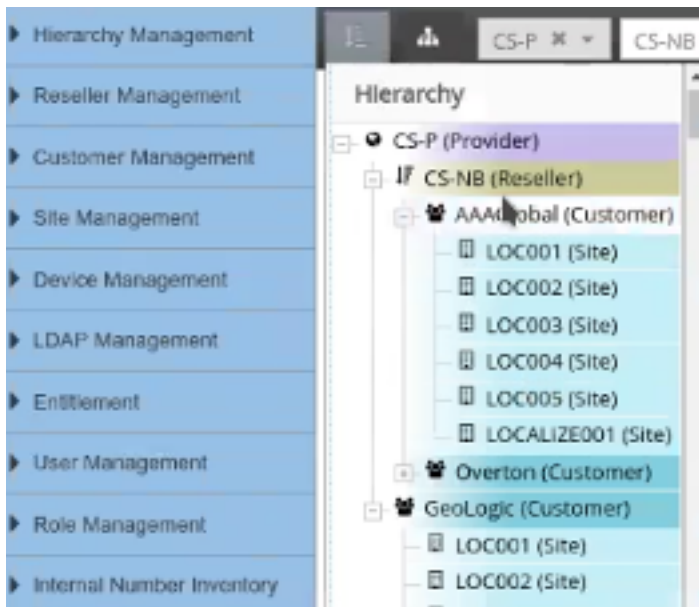

- Hierarchy Pop-up view

Use the hierarchy pop-up view icon on the hierarchy bar to show a pop-up box with a drop-down list of nodes available from the current hierarchy - according to the hierarchy rules that apply to the current node and user.

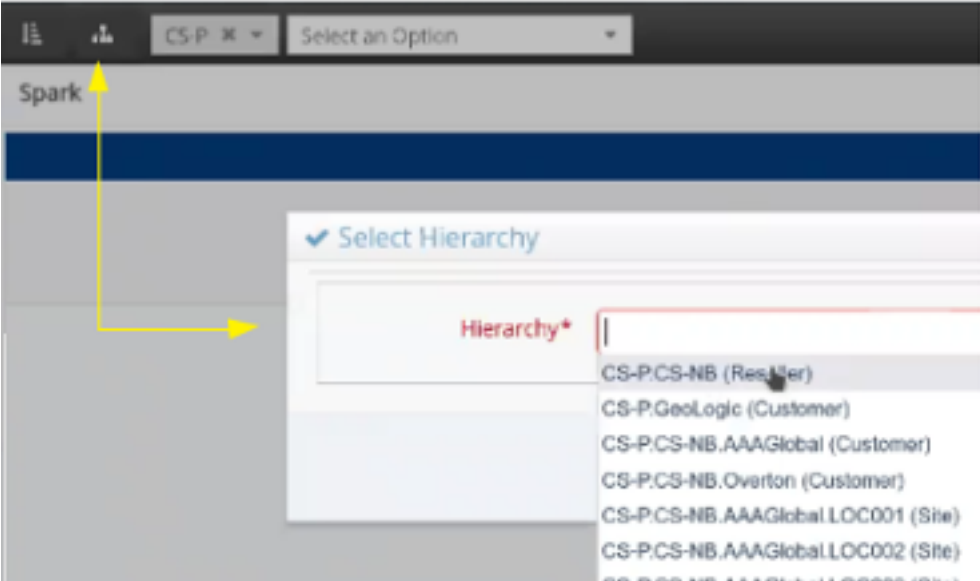

The input drop-down box can also be used for a *case insensitive* search with a string *contained* in the name of the required node, thereby filtering the drop-down list.

Since the nodes in the drop-down list also show the node hierarchy type (Provider, Reseller, Customer, Site), the list can therefore also for example be filtered case insensitively to show those for example containing "Site".

- List view hierarchy links

For list views, the hierarchy level to which an object belongs is indicated in the hierarchy column is called **Located At**. The hierarchy level name and type shows as the column hierarchy link, for example [Overton \(Customer\)](#).

All the entries in the list that the logged in user's hierarchy rules allows for, will show as hyperlinks. This also applies to list views of search results.

Clicking on the hierarchy link will set the hierarchy to the selected hierarchy in the top "bread crumbs" bar and the items in the list view are filtered accordingly.

Last Name	Email	User Type	Entitlement Profile	Located At
Pjones	pjones@voss-solutions.com	CUCM Local		Overton (Customer)
Bulld001	OscarBulld001@aaaglobal.com	CUCM Local		Overberg (Site)
Bulld002	OscarBulld002@aaaglobal.com	CUCM Local		Overberg (Site)
Bulld003	OscarBulld003@aaaglobal.com	CUCM Local		Overberg (Site)
Jones	pjonesss@voss-solutions.com	CUCM Local		Overberg (Site)

Note: The hierarchy bar is not refreshed automatically when for example Customers or Sites are deleted by another administrator user on another browser. The bar is refreshed when refreshing the browser.

4.4. View the Hierarchy

An administrator can view the portion of the hierarchy they have access to.

- A provider administrator can view the complete hierarchy.
- A customer administrator can view the customer, any intermediate nodes beneath the customer, and customer sites.

View, sort, and search the hierarchy

- You can view the hierarchy on the relevant hierarchy list view. Hierarchy nodes visible to the administrator display in a table:

Field	Description
Name	Node name
Description	Node description
Hierarchy Node Type	Either Provider, Reseller, Customer, or Site. Blank for an intermediate node.
Located At	The node location in the hierarchy, in dot notation.

- To view a subset of the visible hierarchy, adjust the hierarchy path. For example, if a provider administrator sets the path to point to a particular customer, they can see only the hierarchy nodes for that customer.
- To sort hierarchy nodes, click on the field headers.
- To search hierarchy nodes, click the search icon on the field headers.

See also

Navigating the Hierarchy in the Core Feature Guide

4.5. Site Defaults Doc Templates

When a provider hierarchy is created in VOSS-4-UC, a workflow creates a default Site Defaults Doc Template (SDD template) called `PROVIDER_TEMPLATE` at the provider level.

The data in this template is in turn used to generate a customer-level default SDD template called `CUSTOMER_TEMPLATE` for each customer added to the system under the respective provider hierarchy.

When creating a site, a SDD instance is created on the site using the `CUSTOMER_TEMPLATE`. The site level SDD is useful for managing multi-site, multi-country customers and allows a provider administrator (or higher) to define geo-specific information at a site level, allowing multinational sites to stay in sync.

The site level SDD has the same name as the new site, and is also pre-populated with several default values. Site level SDDs provide the default values for several of the tasks performed during onboarding.

For Provider deployments, when creating a Cisco HCS site dial plan, the site defaults on the site are updated with dial-plan-related attributes that are affected by the deployed site dial plan. Any related existing values are overwritten. When the site dial plan is removed, these values are reset (set to empty) in the site defaults.

Administrators with the required permissions can modify the `PROVIDER_TEMPLATE` and `CUSTOMER_TEMPLATE` SDD templates as required in order to customize SDD settings in the template during the creation of lower level SDDs and SDD templates. The default SDD templates are shown in the list view of the **Site Defaults** menu.

Related Topics

- [Modify Site Defaults](#)

4.6. Create a Provider

This procedure creates a provider hierarchy node in VOSS-4-UC and, optionally, a default provider administrator.

Note: In VOSS-4-UC, the provider name is set to the current service provider name in HCM-F (if applicable).

Perform these steps:

1. Log in to VOSS-4-UC as entadmin at sys.hcs.
2. On the **Providers** form (default menu **Provider Management > Providers**), click **Add**.
3. On the **Service Provider Details** tab, complete the following fields:

Field	Description
Name	<p>The name of the provider. The name is automatically set to the current service provider name in HCM-F (if applicable). You can keep the existing name or overwrite with a more meaningful name. This field is mandatory.</p> <p>Note: Once you have saved the provider, you cannot change the provider name.</p> <p>Note: Any spaces in the provider name are converted to underscores in the provider local administrator name and email, if the Create Local Admin check box is selected.</p>
Description	A description of the provider.
Domain Name	The domain of the provider. For example, provider.com. Used when creating the default local administrator so the administrator can log in with an email ID such as ProviderAdmin@provider.com . This field is mandatory.
Create Local Admin	Controls whether a default local administrator is created.
Cloned Admin Role	The ENT default provider role used to create a new role prefixed with the provider name. The created provider role, shown in Default Admin Role field, is assigned to the default local administrator. This field appears only if the Create Local Admin check box is selected.
Default Admin Role	The created provider role that is assigned to the default local administrator. This field is read-only and appears only if the Create Local Admin check box is selected.
Default Admin Password	The password to assign to the default local administrator. This mandatory field appears only if the Create Local Admin check box is selected.
Repeat Default Admin Password	Confirm the default local administrator password. This mandatory field appears only if the Create Local Admin check box is selected.

4. On the **Contact Information** tab, enter address, email, and phone information as appropriate.
5. Click **Save**.

4.7. Create a Reseller

After VOSS-4-UC installation, the entadmin Administrator must configure the HCM-F device (if applicable) and create the Provider. Creating a reseller is optional.

1. Log in as provider administrator.

Log in with the Provider administrator's email address, which is case-sensitive. The hcsadmin administrator can find the Provider administrator's email address on the **Admins** form (default menu **User Management > Admins**) by clicking the Provider name.

2. On the **Resellers** form (default menu **Reseller Management > Resellers**) click **Add**.
3. On the **Reseller Details** tab, complete these fields:

Option	Description
Name	The name of the reseller. This field is mandatory. Note: Once you save the reseller, you cannot change the reseller name. Note: Any spaces in the reseller name are converted to underscores in the reseller local administrator name and email, if the Create Local Admin check box is selected.
Description	Reseller description
Directory Domain	Reseller domain. This field is used to create an email address for the reseller default local administrator, for example Reseller1Admin@reseller1.com . If omitted, the domain of the provider is used.
Create Local Admin	Controls whether a default local administrator is created for the reseller.
Cloned Admin Role	The Provider role used to create a new role prefixed with the reseller name. The created reseller role, shown in the Default Admin Role field, is assigned to the default local administrator user. This field appears only if the Create Local Admin check box is selected.
Default Admin Role	The created reseller role that is assigned to the default local administrator. This field is read-only and appears only if the Create Local Admin check box is selected.
Default Admin Password	The password to assign to the default local administrator. This field appears and is mandatory only if the Create Local Admin is selected.
Repeat Default Admin Password	Confirm the default local administrator password. This field appears and is mandatory only if the Create Local Admin check box is selected.

4. On the **Contact Information** tab, enter address, email, and phone information as appropriate.
5. Click **Save**.

4.8. Create Intermediate Node

An intermediate node is an optional node in the VOSS-4-UC hierarchy that is located between the standard hierarchy nodes: provider, reseller, customer, and site. An intermediate node can be used to logically group other nodes. Intermediate nodes can be used to restrict access by administrators to a defined subset of nodes.

For example, intermediate nodes could be used to group customers by industry, or sites by geography.

When an intermediate node is created, no default administrator is created for it. Adding an administrator for an intermediate node is a separate step.

Perform these steps:

1. Log in as an administrator at the level under which you want to create the intermediate node.
For example, to create an intermediate node to group sites, log in as the customer administrator.
2. From the **Hierarchy** form click **Add**.
3. Enter the following information for the node:

Field	Description
Name	The name of the node. This field is mandatory. Note: Once you enter a name, it cannot be changed.
Description	A detailed description of the node (optional).

4. Click **Save**.

The intermediate node is created in the hierarchy.

Next Steps

- Define a local administrator for the intermediate node.
- Then create nodes underneath the intermediate node that the intermediate node local administrator can manage.

4.9. Delete a Hierarchy

Caution: Unintentionally deleting a hierarchy can have serious effects on the system. Proceed with caution.

A utility is available under a hierarchy management menu to delete a hierarchy (Provider, Reseller, Customer, Site, IntermediateNode) and all data under it.

If the utility is used at a higher level hierarchy, then select the lower level hierarchy to delete from the drop-down list.

Check box options are available to:

- remove data on selected UC Apps configured on the hierarchy

- remove the hierarchy data from the VOSS-4-UC system database completely

Note:

- If a site is deleted, an additional cleanup workflow step also removes site related data above the site level.
- If no check boxes are selected, the transaction is successful and no data is deleted.

Since there is a risk in using this utility, a confirmation of the action is required by selecting the **Confirmation** drop down box. Click **Save** to carry out the transaction.

4.10. Delete Issues and Purges

Whenever Unified CM and CUCX data is synced into VOSS-4-UC, it assumes management of the data and, as a result, that data would be deleted by any hierarchy delete performed in VOSS-4-UC. These deletes can fail if your Cisco Unified Communications Manager model dependencies don't reflect the additional data contained in existing, provisioned dial plans brought into VOSS-4-UC.

To prevent these delete failures, perform a purge operation instead of a delete. Purging deletes all users, subscribers, phone, profiles, and devices from a brownfield customer's VOSS-4-UC while leaving these objects on the Unified CM and the Cisco Unity Connection.

To execute a purge:

1. Log in to VOSS-4-UC as a reseller administrator or higher.
2. Access the **Data Sync** form (default menu **Administration Tools > Data Sync**).
3. From the hierarchy drop-downs, choose the customer whose data you need to purge. If the data was created at the Site hierarchy, the purge only takes place at site level.
4. Click **HcsPurge-<IP address + fully qualified domain name + hostname>**.
5. From the **Sync Type** drop-down, choose **Purge Local Resources**. All other default values remain unchanged.
6. Click **Execute**.
7. Repeat steps 4-6 for the Unified CM.
8. Verify that the instances and device models are deleted by checking Phones, Users, and Voicemail.

At this point, you can try again to migrate the customer into VOSS-4-UC by executing HcsPull from the same menu for Unified CM and Unity Connection, and then performing the Overbuild operations.

4.11. Set Localization Language at Hierarchy Node

A default language can be set at any hierarchy node. Users and local administrators will inherit the default language from the nearest hierarchy node in the hierarchy tree that has a default language set. If no default language is specified, English is used. The default language can be overridden for an individual user or local administrator under User Management.

Perform these steps:

1. Log in as provider, reseller, customer, or site administrator.

2. Set the hierarchy path to point to the node where you want to set a default language.
3. On the **Localization Language** form (default menu **Hierarchy Management > Localization Language**) click **Add**.
4. From the **Language** drop-down, choose the default language and click **Save**.

As an example, a provider has not set a default language at the provider level. The provider has a reseller in Germany, so the default language at the reseller is German. But that reseller has a customer in France, so the default language at that customer level is set to French. In addition, the customer in France has a site in Italy, so the default language for that site is set to Italian. In this scenario, users that are not under the reseller have English as their language by default.

5. Customer Management

5.1. Create a Customer

1. Log in as provider or reseller administrator, depending on which organization manages the customer.
Log in with the provider or reseller administrator's email address, which is case-sensitive. The provider administrator can find the reseller administrator's email address on the **Admins** form (default menu **User Management > Admins**) by clicking the reseller.
2. If logged in as provider, and the customer is to be added under a reseller, set the hierarchy path to the reseller.
3. On the **Customers** form (default menu **Customer Management > Customers**) click **Add**, or to modify select a customer.
4. Complete or modify the following fields:

Field	Description
Customer Name	The name of the customer. This field is mandatory. Note: Any spaces in the customer name are converted to underscores in the customer local administrator name and email, if the Create Local Admin check box is selected.
Description	Customer description
Domain Name	Customer domain. This field is used to create email addresses for: <ul style="list-style-type: none"> The customer default local administrator, for example: Customer1Admin@customer1.com Site default local administrators under the customer, for example: Site1Admin@customer1.com If the customer domain is omitted, the provider domain (or reseller domain, if the customer is under a reseller in the hierarchy and the reseller domain was provided) is used instead.
Public Sector	Set the Customer as a Public Sector customer. Used for License Reporting.
Inactive Billing	Exclude customer from billing (for testing). Used for License Reporting.
Create Local Admin	Controls whether a default local administrator is created for the customer.
Cloned Admin Role	The Provider or Reseller role used to create a new role prefixed with the customer name. The created customer role, shown in the Default Admin Role field, is assigned to the default local administrator user. This field appears only if the Create Local Admin check box is selected.
Default Admin Role	The created customer role that is assigned to the default local administrator. This field is read-only, and appears only if the Create Local Admin check box is selected.
Default Admin Password	The password to assign to the default local administrator. This field appears and is mandatory only if the Create Local Admin check box is selected.
Repeat Default Admin Password	Confirm the default local administrator password. This field appears and is mandatory only if the Create Local Admin check box is selected.
Prime Collaboration	Prime Collaboration is the application which monitors equipment used by this customer. Available Prime Collaboration applications must first be configured using the HCM-F User Interface. Then HCM-F synchronization must be executed on VOSS-4-UC. After the HCM-F data syncs into VOSS-4-UC, available Prime Collaboration applications will appear in this dropdown. Select an available Prime Collaboration application to monitor Unified Communications applications and customer equipment configured for this customer. To unassociate Prime Collaboration for this customer, choose None.
Shared UC Applications	Indicates whether the customer can use Shared UC Apps. If selected, the customer sites can use Network Device Lists that contain Shared UC Apps. Shared UC Apps are UC Apps that are defined above the Customer hierarchy level.
Disable Number Management	Enable or disable Number Management for this customer. <ul style="list-style-type: none"> If selected, you cannot add Directory Numbers and E164 Numbers to inventories for this customer. If <i>not</i> selected, you can add Directory Numbers and E164 Numbers to inventories for this customer.

If you enable Number Management for a customer after it was disabled, run the DN Audit Tool - see [Audit Number Inventory](#).

5. Click **Save**.

Note: When deleting a customer, remove any entities associated with the customer like LDAP, SSO providers, Devices, and NDLs.

5.2. Network Device Lists (NDL)

5.2.1. Network Device Lists (NDL)

A network device list (NDL) is a list of network devices that are assigned to a site. NDLs are defined at the customer hierarchy level, and a customer can have multiple NDLs.

Only a Provider or Reseller administrator may create NDLs.

Shared UC applications (that is, UC Applications defined above the customer hierarchy level) can be included in an NDL. However, to use that NDL, the customer must be defined as allowing Shared UC Applications.

Each NDL can contain one instance each of the available devices. For example, for Cisco, one of each of the following: HCM-F, CUCM, CUC, Cisco WebEx. In this case, only Cisco HCM-F is required.

Note:

- References to HCM-F and Shared Data Repository (SDR) are only relevant if installed. The HCM-F device is pre-populated in the NDL and should not be changed.
 - UC application clusters are linked to a customer only once the NDL is created.
-

Related Topics

- Add a Network Device List (NDL) in the Core Feature Guide
- VOSS-4-UC Configuration and Sync in the Core Feature Guide

5.2.2. Add a Network Device List (NDL)

This procedure adds a new network device list (NDL).

Perform these steps:

1. Log in as a provider or reseller administrator.
2. Go to (default menus) **Customer Management > Network Device Lists**.
3. Choose a customer on the hierarchy tree where the NDL is to be created.
4. Click **Add**.
5. Enter a name for the NDL, and optionally a description.

6. For each available network device that you wish to add to the NDL:
 - Click the Plus (+) to display the search field.
 - Click the down-arrow at the search field to select the reference instance.

Note: For CUCM and CUC, only publisher nodes display in the drop-downs.

- Click **Save**.

Edit or Delete a NDL

Once you've assigned a NDL to any site, you can't delete it; you can only make the following changes:

- The NDL name can be changed.
- The NDL description can be changed.
- New devices can be added.

Deleting an unassigned NDL does not remove the associated customer dial plans or the assigned UC apps.

Related Topics

- Network Device Lists (NDL) in the Core Feature Guide
- VOSS-4-UC Configuration and Sync in the Core Feature Guide

5.2.3. Choosing a Network Device List

If an administrator at a hierarchy has access to more than one network device list (NDL), the option to choose a specific hardware group or list may be needed in order to provision a set of devices.

The Rule Model Device Selection Type model solves this problem, and instances of it are a set of rules for views and relations at a hierarchy level. A particular NDL can then be selected from a popup form before the Add form of these model types are shown. In this way, the administrator can then select the specific required NDL.

When an instance of the Rule Model Device Selection Type model is added, the target relation or view is specified and more than one set rules can be added for it - one for each relevant Hierarchy Node Type.

In addition, a Default GUI Rule that is applied to the Relation or View is reflected as the Default value for the Permitted Hierarchy Node Type.

In addition to this behavior, these rules apply:

- The NDL popup is only available for Relations and Views.
- Device form fields are filtered according to the device listed in the selected NDL.
- More than one type of device is supported for the selected NDL.
- Any Provisioning Workflow Network Device Filters (NDF) override a selected NDL device choice.
- Only the Add operation supported.
- For details on NDL popups, refer to the topic on Network Device List Selection Rules Advanced Configuration in the Advanced Configuration Guide.

Related Topics

- Network Device Lists (NDL) in the Core Feature Guide

5.2.4. Network Device Lists (NDLs) at a Site

The following rules apply to Network Device Lists (NDLs), network devices and device models at site hierarchies:

For a site which references a NDL, device models cannot exist at this site if these belong to a network device not referenced in the NDL.

Therefore:

1. A device model from a device cannot be added to it if it has a NDL referencing a different device.
2. A NDL cannot be added to it if it has device models that references a different network device than the one referenced in the NDL.

Related Topics

- Network Device Lists (NDL) in the Core Feature Guide

5.3. CUCM Group Selection

5.3.1. CUCM Group Selection

Provider level administrators can manage the Default CUCM Group setting in a customer's Site Defaults:

- The least utilized Group can be calculated, in other words the group with the least number of phones can automatically be determined.

In this case, the administrator can set the Default CUCM Group in the customer's Site Defaults to automatically be the least utilized group so that CUCM Groups are optimally assigned whenever a site is created.

- The current device utilization of customer CUCM Groups can be inspected. Device utilization is calculated by inspection of the Device Pools that belong to a CUCM Group of a CUCM cluster and the number of Phones in these Device Pools.

The administrator can therefore inspect the CUCM Group counts and then choose a Default CUCM Group to be the Default CUCM Group in the customer's Site Defaults.

High level administrators carry out these tasks from the **Customer Management > Advanced > CUCM Group Selection** and **CUCM Group Counts** menus.

5.3.2. Select a CUCM Group

1. Log in as a Provider administrator and select **Customer Management > Advanced > CUCM Group Selection**.
2. The list of existing CUCM Group Selection configurations at the Provider hierarchy are listed.
Click **Add** to create a configuration. A hierarchy pop-up will show to choose the customer hierarchy at which the configuration should apply.
3. Choose a Name for the configuration. The default name is the hierarchy name.
4. Choose an Algorithm to apply to the CUCM Group Selection:

- If Use Default is selected, the Site Defaults doc is updated if necessary so that the Default CUCM Group is applied.

Note: The CUCM Group called Default is always used when adding a Site unless the “Least utilized” algorithm has been selected. Default will also be the fallback CUCM Group in the event that all CUCM Groups have been excluded from the selection.

- If Least utilized CUCM Group is selected from the Algorithm drop-down, options are available to include and exclude specific CUCM groups from the algorithm.
 - If no groups are included or excluded, *all* groups available at the customer hierarchy are considered by the algorithm.
 - If groups are added to the CUCM Groups to Include, only these groups are considered by the algorithm.
 - If groups are added to the CUCM Groups to Exclude, these groups are not considered by the algorithm, *unless* they have also been added to the Groups to Include.

The table below summarizes the options and outcomes:

Group Selection	Algorithm	Include List	Exclude List	Result	Comment
No	Use Default	N/A	N/A	Default	Falls back to Default always
Yes	Use Default	None	None	Default	
Yes	Least utilized	None	None	Least utilized	
Yes	Least utilized	Yes	None	Least utilized	From the groups in the included list.
Yes	Least utilized	None	Yes	Least utilized	Least utilized from all groups except in the exclude list.
Yes	Least utilized	Yes	Yes	Least utilized	From the groups in the included list. Note that the exclude list will be ignored in this case.

5. Click **Save** to save the configuration for the customer hierarchy. When a new site is created, the Default CUCM Group in the Site Defaults Doc is updated to reflect the configuration, so that any sites that are now created under this customer hierarchy will apply the calculated CUCM Group.

Note that an administrator can override this calculated CUCM Group by manually updating the Site Defaults Doc.

5.4. CUCM Group Counts

5.4.1. CUCM Group Counts

1. Log in as a Provider administrator and choose **Customer Management > Advanced > CUCM Group Counts**.
2. From the **CUCM** drop-down, choose a CUCM instance to show the CUCM Group counts for.
3. The **CUCM Group counts** field shows all CUCM groups and the count of devices in the format: `<group_name>[*<count>]`.
If a CUCM Group has no device pool, in other words it has no devices, the group shows as `<group_name>[0 no device pools]`.

The administrator can use the CUCM Group Count data to inspect CUCM Group utilization at a customer, or to choose a Default CUCM Group that will be assigned to a customer's Site Defaults Doc.

Note: Group Counts values are Phone counts per Device Pool per CUCM Group.

5.5. Extension Mobility Cross Cluster (EMCC)

5.5.1. Extension Mobility Cross Cluster (EMCC) Configuration

Extension Mobility Cross Cluster (EMCC) extends VOSS-4-UC's current extension mobility functionality to allow the user to log in to a device, from within a connected cluster, anywhere in the world. This enables the user to retain the settings, services and lines he/she is familiar with at their home location.

VOSS-4-UC automates most of the EMCC provisioning to enable this feature to work on all dial plans across multiple Cisco Unified Communications Manager (Unified CM) clusters that are managed by the same platform instance. A small number of manual configurations remain, specifically around network security, which is outlined in a separate section. VOSS-4-UC only automates provisioning of the home cluster in cases where the Unified CM clusters are managed by separate platforms, that is, cross-cluster configuration across multiple platforms is not supported.

EMCC Use Case

HOME Cluster	VISITING Cluster
User Profile	Phone (with Geolocation)
Geolocation Filter	
Roaming Device Pool (with Geolocation)	

- A user from the HOME cluster goes to the VISITING cluster and logs onto a phone. The two clusters can be in different countries/territories.
- The user cannot be authenticated in the VISITING cluster, but since the cluster is EMCC enabled, and the phone is subscribed to the EMCC service, the cluster searches for the user in defined EMCC remote clusters.
- Once the user (also subscribed to the EMCC service) is authenticated, the phone is unregistered from the VISITING cluster, and re-registered to the HOME cluster.
- The geolocation of the phone is sent to the HOME cluster. This enables the HOME cluster to associate the relevant roaming device pool to the user's phone using the geolocation filter.
- The phone behaves and dials exactly the same as if the user was logged in at the HOME cluster, and all his/her settings and preferences are preserved.
- Calls to the HOME cluster emergency numbers as well as the VISITING cluster emergency numbers break out at the VISITING cluster (physical location).
- Various other elements such as trunks, EMCC countries, and so on, must be configured on both the HOME-and VISITING clusters to ensure the feature functions.

Note: Refer to the “Cisco Unified Communications Manager Features and Services Guide” for more information about the EMCC feature.

Prerequisites for Configuring EMCC using VOSS-4-UC

Before you can configure Extension Mobility Cross Cluster (EMCC) using VOSS-4-UC, make sure that the following parameters have already been configured on each required EMCC cluster (Unified CM) located at the relevant Customers:

- EMCC Feature Configuration such as Default TFTP Server for EMCC Login Device, EMCC Geolocation Filter

5.5.2. EMCC Group Management

An Extension Mobility Cross Cluster (EMCC) group is a collection of clusters and countries that essentially forms an 'EMCC Cloud', which determines the specific clusters between which a user can roam.

Note: A cluster can only be included in one group.

EMCC groups typically cater for situations where all the clusters are in different countries, and are managed by the same platform instance. To support multiple clusters in the same country, you need to refine the

geolocations and geolocation filters to uniquely identify the clusters in the default provisioning of country. This is supported by using the home cluster setup for each of the clusters in the group.

The EMCC Group screen allows a provider administrator to add or remove clusters and countries to or from an EMCC group, or to modify/delete an existing EMCC Group.

Note: To delete an EMCC Group, click on the Group to delete on the EMCC Group screen and then click **Delete** on the button bar.

See also:

- [Add an EMCC Group](#)
- [Modify an EMCC Group](#)

5.5.3. Add an EMCC Group

When adding an EMCC Group, the cluster the user is on when taking this action is automatically selected/included in the new group.

Prerequisites:

- Create the required route patterns. See [Add EMCC Route Pattern](#).

Perform these steps:

1. Log in as provider administrator or higher.
2. Choose **Customer Management > EMCC > EMCC Group**.
3. Click **Add**.
4. Choose the required customer from the **Hierarchy** drop-down list. The **EMCC Group** screen is displayed.
5. Enter the mandatory EMCC Group Name in the **Name** field.
6. Choose the required CUCM Clusters and Countries to include in the EMCC Group by selecting single or multiple entries in the **Available** areas of the screen, and then clicking **Select** to move them to the **Selected** area of the screen. Use the Remove, Move Up and Move Down buttons as required to assist in creating the EMCC Group. An EMCC Group **must contain** a minimum of two clusters.
7. Make sure that the required CUCM Clusters and Countries are listed in the CUCM Clusters and Countries areas of the screen respectively.
8. Click **Save** to add the EMCC group to VOSS-4-UC.

Upon creation of the EMCC Group, the following elements are provisioned per country and EMCC route pattern:

- Route list
- Geolocation filter
- SIP profile
- IP phone services
- SIP trunk
- Geolocation

- Route partition
- CSS
- Device pool
- Route pattern

5.5.4. Modify an EMCC Group

1. Log in as provider administrator or higher.
2. Choose **Customer Management > EMCC > EMCC Group**.
3. Click on the EMCC Group that you want to modify. The selected **EMCC Group** screen is displayed.
4. Add or remove the CUCM Clusters and Countries within the EMCC Group by selecting single or multiple entries in the **Available** or **Selected** areas of the screen, and then clicking **Select** or **Remove** to include or exclude them from the group as required. Use the Move Up and Move Down buttons as required to assist in creating the EMCC Group.
5. Click **Save** to save the modified EMCC group to the VOSS-4-UC database.

5.5.5. EMCC Route Patterns

See:

- [Add EMCC Route Pattern](#)
- [Modify EMCC Route Pattern](#)

5.5.6. Add EMCC Route Pattern

1. Log in as provider administrator or higher.
2. Make sure that the hierarchy path is set to the correct customer node.
3. Choose **Customer Management > EMCC > EMCC Route Patterns**.
4. Click **Add** to add an EMCC Route Pattern. The **EMCC Route Patterns** screen is displayed.
5. Enter the following fields as required:
 - a. **Country**. Choose the relevant ISO country code from the drop-down list.
 - b. **Pattern**. Enter the route pattern, including numbers and wild cards. Do **not** use spaces in your route pattern.
 - c. **Called Party Transformation Mask**. Enter a transformation mask value. Valid entries include digits 0 to 9, the wild card character X. Note that if this field is left blank, no calling party transformation takes place.
6. Click **Save** when complete to add the EMCC Route Pattern.

5.5.7. Modify EMCC Route Pattern

1. Log in as provider administrator or higher.
2. Make sure that the hierarchy path is set to the correct customer node.
3. Choose **Customer Management > EMCC > EMCC Route Patterns**.
4. Click the EMCC Route Pattern that you want to modify.
5. Update the following fields as required:
 - a. **Country**. Choose the relevant ISO country code from the drop-down list.
 - b. **Pattern**. Enter the route pattern, including numbers and wild cards. Do **not** use spaces in your route pattern.
 - c. **Called Party Transformation Mask**. Enter a transformation mask value. Valid entries include digits 0 to 9, the wild card character X. Note that if this field is left blank, no calling party transformation takes place.
6. Click **Save** when complete to save the changes to the EMCC Route Pattern.

Note: To delete an EMCC Route Pattern, click on the pattern to delete on the **EMCC Route Patterns** list view, and then click **Delete** on the button bar.

5.5.8. EMCC Templates

Use EMCC templates to define the common EMCC attributes to add a group of new EMCC. Prior to creating the template, make sure EMCC settings have already been configured in Cisco Unified Communications Manager Administration.

See also:

- [Configuration Templates](#)

5.5.9. Clone and Add EMCC Template

1. Log in as provider administrator or higher.
2. Make sure that the hierarchy path is set to the correct customer or location node.
3. Choose **Customer Management > EMCC Templates**.
4. Click on the EMCC Template from which you want to create a new EMCC Template.
5. Click **Action > Clone**. The selected EMCC Template is cloned. See also [Creating a Configuration Template](#) for more information.
6. Enter a new **Name** for the EMCC Template. This is mandatory field.
7. Edit existing fields, and add new fields as required.
8. Click **Save** to add the EMCC Template.

5.5.10. Modify EMCC Template

1. Log in as provider administrator or higher.
2. Make sure that the hierarchy path is set to the correct customer or location node.
3. Choose **Customer Management > EMCC Templates**.
4. Click on the EMCC Template that you want to edit. See also [Creating a Configuration Template](#) for more information.
5. Edit and add the required fields, making sure that all mandatory fields are complete.
6. Click **Save** to save the modified EMCC Template.

Note: To delete an EMCC Template, click on the template to delete on the EMCC Templates list view, and then click **Delete** on the button bar.

6. Site Management

6.1. Create a Site

1. Log in as provider, reseller, or customer administrator.
2. Make sure that the hierarchy is set to the customer for whom you are creating the site.
3. On the **Sites** form (default menu **Site Management > Sites**) click **Add**.
4. Complete the following fields:

Option	Description
Site Name	The name of the site. This field is mandatory. Note: Any spaces in the site name are converted to underscores in the site local administrator name and email, if the Create Local Admin check box is selected. When migrating a customer location to a site, an NDL is not selected for the site. You can set the NDL for the site later.
Description	A description for the site
Create Local Admin	Controls whether a default local administrator is created for the site.
Cloned Admin Role	The customer role used to create a new role prefixed with the site name. The created site role, shown in the Default Admin Role field, is assigned to the default local administrator user. This field appears only if the Create Local Admin check box is selected.
Default Admin Role	The created site role that is assigned to the default local administrator. This field is read-only and appears only if the Create Local Admin check box is selected.
Default Admin Password	The password to assign to the default local administrator. This field appears only if the Create Local Admin check box is selected.
Repeat Default Admin Password	Confirm the default local administrator password. This field appears only if the Create Local Admin check box is selected.
Country	Select the Country from a drop-down of countries. This field is mandatory.
Network Device List	Choose the NDL containing the UC applications and WebEx to be used by the site. Once an NDL has been set for the site, it cannot be removed from the site, nor can the NDL be changed to another NDL.
Auto Push Users to CUCM	If enabled, users are automatically pushed to the Cisco Unified Communications Manager that is associated with the NDL. The default is disabled. Note: You can edit the site later, and select this check box for one of the following reasons: <ul style="list-style-type: none"> • To automatically push users at the site to the Cisco Unified Communications Manager. User surname must be filled in. • To perform an Auto User Push when an NDL is added to the site. • To perform an Auto User Push when a Cisco Unified Communications Manager is associated with an NDL. Only users with user type "End User" are pushed to the Cisco Unified Communications Manager.

5. Click **Save**.

Once saved, the following occurs:

- A Site hierarchy node is created.
- A Location is created.
- Optionally, a default site administrator is created.
- If the **Auto Push Users to CUCM** check box is selected:
 - All users associated with the NDL are pushed to the Cisco Unified Communications Manager associated with the NDL. User surname must be filled in.
 - Only users with user type "End User" are pushed to the Cisco Unified Communications Manager.

6.2. Modify Site Defaults

This procedure displays and updates site defaults.

Note: Site defaults provide the default values for several of the tasks performed during onboarding. When creating a site, a site defaults instance is created on the site, having the same name as the new site, and pre-populated with several default values.

For Provider deployments, when creating a Cisco HCS site dial plan, the site defaults on the site are updated with dial-plan-related attributes that are affected by the deployed site dial plan. Any related existing values are overwritten. When the site dial plan is removed, these values are reset (set to empty) in the site defaults.

The Site Defaults Doc (SDD) is useful for managing multi-site, multi-country customers. A SDD allows a Provider administrator (or higher) to define geo-specific information at a site level, allowing multinational sites to stay in sync.

Geo-specific information includes CUCM user-locale and network-locale defaults, as well as the CUC time zone and language defaults.

See Also:

- Site Defaults Doc Templates in the Core Feature Guide.

Perform these steps

1. Log in to VOSS-4-UC (to the Admin Portal or to the Business Admin Portal), as provider, reseller, or customer administrator.
2. Open the site defaults editing screen:
 - In the Business Admin Portal, go to **Site Management > Site Defaults**; then, select the relevant site to open the Site Defaults[name] screen.
 - In the Admin Portal, go to **Site Management > Defaults** to open the Defaults screen; then, select the relevant site to open the Defaults[name] screen.
3. Click through the following tabs to modify default values, as required in accordance with your devices and vendors:
 - General Defaults
 - Device Defaults
 - Line Defaults
 - User Defaults
 - CUC Defaults
 - HotDial Defaults
 - Overbuild Defaults
 - MS Teams
4. Save your changes.

Note:

- Field descriptions for the tabs on this screen are documented below.
- Note that the SDD also contains ten custom string fields and ten custom boolean fields, which are, by default, untitled and hidden:

- custom_string_1 to custom_string_10
- custom_boolean_1 to custom_boolean_10

To enable and use these fields, higher-level administrators can modify the field display policy for the SDD (at a specific hierarchy). Once the fields are available, designers can reference the fields in custom configuration templates and workflows.

6.2.1. General Defaults Tab

Option	Default Value
Name	Mandatory. The same name as the site. Only one instance of site defaults exists for a site.
Default CUCM Device Pool	Cu{CustomerId}Si{SiteId}-DevicePool
Default CUCM Location	Cu{CustomerId}Si{SiteId}-Location
Default CUCM Region	Cu{CustomerId}Si{SiteId}-Region
Default CUCM Date/Time Group	CMLocal For Provider deployments, choose from the drop-down list.
Default User Locale	The user locale identifies a set of detailed information to support users at the specific location, including language and font. Choose the required user locale from the drop-down list, which contains all user locales available on the CUCM at the selected location.
Default Network Locale	The network locale contains a definition of the tones and cadences that the phones and gateways use at the specific location. Choose the required network locale from the drop-down list, which contains all network locales available on the CUCM at the selected location.
Default User Profile (for User Self Provisioning)	Choose from the drop-down list.
Default CUCM Hunt Pilot Partition	Cu{CustomerId}Si{SiteId}-Feature-PT
Default CUCM Call Pickup Partition	Cu{CustomerId}Si{SiteId}-Feature-PT
Default CUCM Call Park Partition	Cu{CustomerId}Si{SiteId}-Feature-PT
Default CUCM MeetMe Partition	Cu{CustomerId}Si{SiteId}-Feature-PT
Default CUCM Group	Default value: Default

6.2.2. Device Defaults Tab

Values on the **Device Defaults** tab are applied to the configuration template associated with adding a subscriber (SubscriberPhonePrePopulate).

Option	Default Value
Default CUCM Phone Product	Cisco 9971
Default CUCM Phone Protocol	SIP
Default CUCM Phone Button Template	Standard 9971 SIP
Default CUCM Phone Security Profile	Cisco 9971 - Standard SIP Non-Secure Profile
Default CUCM Phone Softkey Template	Standard User
Default CUCM Phone SIP Profile	Standard SIP Profile
Default CUCM Phone Presence Group	Standard Presence Group
Default CUCM Phone Common Profile	Standard Common Phone Profile
Default CUCM Phone Line E164 Mask	Enter a E164 mask value that will be applied as a default when devices have not been configured with static values.
Default CUCM Device CSS	Cu{CustomerId}Si{SiteId}-{countryIsoCode}- DP-Emer-CSS
Default CUCM User Subscribe CSS	Internal-CSS
Default CUCM Phone Subscribe CSS	Cu{CustomerId}Si{SiteId}-InternalOnly-CSS
Default CUCM Device Profile Product	Cisco 9971
Default CUCM Device Profile Protocol	SIP
Default CUCM Device Profile Button Template	Standard 9971 SIP

Option	Default Value
Default CUCM Device Profile Line E164 Mask	None. Enter a E164 mask value that will be applied as a default when devices have not been configured with static values.
Default CUCM Device Profile EMCC CSS	None
Default CUCM Remote Destination Profile CSS	None
Default CUCM Remote Destination Profile ReRouting CSS	None
Default CUCM Remote Destination Profile Line E164 Mask	None. Enter a E164 mask value that will be applied as a default when devices have not been configured with static values.
Use National Mask Format	<p>When this check box is selected, the E164 Mask will use the National format of the associated E164 Number.</p> <p>For example, if the E164 Number has been added in the format +44 1234 5000, and this check box is selected, the E164 Mask on the device will have the International Dialing Code prefix removed e.g. +44, and a '0' will be prefixed to the number e.g. 012345000.</p> <p>Note: For Quick Add Subscriber, set the following value in the E164 Mask field of the relevant phone, device profile and remote destination profile configuration template <code>{{ macro.SDD_QAS_E164Number_MCR }}</code>. See the "Reference CUCM Phone Template" CFT for an example configuration.</p>

6.2.3. Line Defaults Tab

Values on the **Line Defaults** tab are applied to the configuration template associated with adding a line (line-cft).

Option	Default Value
Default CUCM Line BLF Presence Group	Standard Presence Group
Default CUCM Line Voice-mail Profile	None
Default CUCM Line Partition	
Default CUCM Line Alternate E164 Partition	None
Default CUCM Line CSS	Cu{CustomerId}Si{SiteId}-InternalOnly-CSS
Default CUCM Line Call Forward CSS	Internal-CSS
Default CUCM Line Call Forward No Answer CSS	Internal-CSS
Default CUCM Line Call Forward All CSS	Internal-CSS
Default CUCM Line Call Forward No Answer Internal CSS	Internal-CSS
Default CUCM Line Call Forward Busy CSS	Internal-CSS

Option	Default Value
Default CUCM Line Call Forward Busy Internal CSS	Internal-CSS
Default CUCM Line Call Forward No Coverage CSS	Internal-CSS
Default CUCM Line Call Forward No Coverage Internal CSS	Internal-CSS
Default CUCM Line Call Forward On Failure CSS	Internal-CSS
Default CUCM Line Call Forward On Failure Internal CSS	Internal-CSS
Default CUCM Line Call Forward Not Registered CSS	Internal-CSS
Default CUCM Line Call Forward Alternate Party CSS	CU1-DummyBlk-CSS
Default CUCM Line Call Forward Secondary CSS	Internal-CSS

6.2.4. User Defaults Tab

Option	Default Value
Default System User Role	{SiteName}SelfService
Default CUCM User BLF Presence Group	Standard Presence group
Default CUCM Service Profile	None
Default Self-service Language	Choose from the drop-down list of installed Self-service languages. Default is English (en-us).

6.2.5. CUC Defaults Tab

For more information about the settings on this tab, see:

Cisco Unity Connection Localization in the Core Feature Guide.

Option	Default Value
Default CUC Phone System	This field is populated by the Voice Mail workflow when a Voice Mail pilot number is associated with a site. Likewise, the field is reset (Empty) when the Voice Mail pilot number is disassociated from a site.
Default CUC Subscriber Template	This field is populated by the Voice Mail workflow when a Voice Mail pilot number is associated with a site. Likewise, the field is reset (Empty) when the Voice Mail pilot number is disassociated from a site.
Default CUC HTML Notification Template	Default_Dynamic_Icons
Default CUC SMPP Provider	None
Default CUC TimeZone	None. Choose from the drop-down list, for example: GMT-05:00-America-New_York. The timezones available in this drop-down are those added in Services > CUC Localization > CUC TimeZone Filters (see cross reference below). You can also manually enter a valid timezone index value in this field, for example 035 for (GMT-05:00) Eastern Time (US and Canada). Note that the code entered must already be installed on the CUC server associated to this site.
Default CUC Language	None. Choose from the drop-down list, for example: English-US. The languages available in this drop-down are those in Services > CUC Localization > CUC Language Filters (see cross reference below). You can also manually enter a valid Locale ID (LCID) value for the language in this field, for example 1036 for French - France. Note that the code entered must already be installed on the CUC server associated to this site.
Default Language That Callers Hear	None. Choose from the drop-down list: <ul style="list-style-type: none"> • Inherit Language From Caller • Use System Default Language • [Use the User Language] e.g. English (United States). See “Default CUC Language” above. • [Choice of Languages] e.g. Spanish (Spain Traditional). See “Default CUC Language” above).

6.2.6. HotDial Defaults Tab

Option	Default Value
Default PLAR CSS	None
Default HotDial TimeZone	None

6.2.7. Overbuild Defaults Tab

The Overbuild Defaults tab is visible only to Provider and Reseller administrators.

Settings on this tab:

- Include Site for Overbuild (yes/no)
- Create Internal Number Inventory at CustomerId (yes/no)
- Overbuild Device Control (e.g., Move All Devices, Limit Moved Devices)
- Add additional device pools

For more information about the settings on this tab, see:

Overbuild Site Defaults: Overview in the Core Feature Guide.

6.2.8. MS Teams Tab

Settings on this tab:

- Allow you to manage MS Azure user deletion on VOSS-4-UC. Set: **Auto Delete VOSS4UC User**
- Specify a dial plan: **Default Tenant Dial Plan** - See:
Configure Microsoft Tenant Dialplan in the Core Feature Guide.
- Set MS Teams policies - See:
Introduction to Microsoft Teams Policies in the Core Feature Guide.
- Select a country for default usage: **Default Usage Location**

7. Apps Management

7.1. VOSS Assurance

7.1.1. VOSS Assurance Monitoring Overview

Users with both VOSS-4-UC and VOSS Assurance deployed, can easily enable monitoring of new UC applications from the VOSS-4-UC administration portal. The integration manages both onboarding and off-boarding of assets to VOSS Assurance Arbitrator servers configured in VOSS-4-UC. The UC apps are monitored by VOSS Assurance through the creation of assets, probes and profiles.

The purpose of the feature is to automate the setup of assets and related configuration for new and existing VOSS-4-UC Customers and UC applications on VOSS Assurance.

With this feature, you can:

- *Voss Assurance Arbitrators*: Set up VOSS Assurance arbitrators in VOSS-4-UC
- *Onboard Voss Assurance Assets*: Onboard Assets: enable monitoring of Unified CM and Unity Connection clusters on one or more VOSS Assurance arbitrator servers.
- *Offboard Voss Assurance Assets*: Offboard Assets: disable monitoring for Unified CM and Unity Connection clusters by removing assets and related configuration from VOSS Assurance. This will remove data from the arbitrators.
- See existing integration(s):
 - Configured VOSS Assurance arbitrator servers
 - Unified CM server - see which arbitrator servers are monitoring the server
 - Unity Connection server - see which arbitrator servers are monitoring the server

Note:

- The Arbitrator Server should be at version SP23 or higher.
 - The feature does not currently allow for the modification of any existing monitoring setup on UC Apps. Deleting a UC app on VOSS-4-UC will however remove the asset and related configuration from all corresponding VOSS Assurance arbitrator servers.
-

7.1.2. Voss Assurance Arbitrators

Prerequisites

The management of arbitrators in VOSS-4-UC require:

- the arbitrators to be set up
- the host connection details and credentials: admin user and password from the arbitrator

Refer to the VAA documentation for arbitrator setup.

Adding an arbitrator to VOSS-4-UC

These steps integrate the arbitrator with VOSS-4-UC by entering its connection details. When integrated, the arbitrator is available to onboard and offboard assets that are added or are available in VOSS-4-UC.

1. Choose the **VOSS Assurance > Arbitrator** menu. This sets the hierarchy at the provider level.
2. Complete the form:
 - **Server Name:** descriptive name of the arbitrator in VOSS-4-UC - note the naming convention restrictions
 - **Description:** an optional description
 - **Host Name:** used to connect to the arbitrator
 - **User Name:** credentials to log in on the arbitrator host: the admin account
 - **Password:** credentials to log in on the arbitrator host: the admin account
 - **Repeat Password:** credentials to log in on the arbitrator host
 - **Data Center:** a free text field used as the location address when arbitrator assets are created.

If the **Sync on Create/Update** check box is selected, the arbitrator server (according to **Host Name**) data from the arbitrator is synced onto VOSS-4-UC (pull sync).

3. Click **Save**.
 - A data sync instance is created: `SyncAssuranceArbitrator__<arbitrator-name>`
 - A data sync instance is created: `PurgeAssuranceArbitrator__<arbitrator-name>`
 - A test connection is automatically carried out when saving the arbitrator details and it can also be used to manually verify input details and connection to the arbitrator host by using the **Action** menu.
 - The list of arbitrators are displayed on the **Arbitrator** menu list view.

Next Steps

Unified CM and Unity Connection servers can now be enabled or disabled for monitoring.

Related Topics

- [Onboard Voss Assurance Assets](#)
- [Offboard Voss Assurance Assets](#)

Removing an arbitrator

An arbitrator can be removed from the list of arbitrators under the **VOSS Assurance** menu.

- Select the arbitrator and choose **Delete**.
- The arbitrator is removed from VOSS-4-UC.
- Integration is removed. The arbitrator is removed from VOSS-4-UC app servers (Unified CM, Unity Connection)
 - On the **Monitoring** group of the UC app server publisher form, the **Assurance Arbitrator** check box is removed.
 - Created pull/purge data syncs on VOSS-4-UC are removed.

7.1.3. Probes, Group Names, Profiles and Timings

- When assets are onboarded, the probe groups and profiles as shown in the tables below are added to the VOSS Assurance and Analytics arbitrator.

Note: For Unified CM and Unity Connection servers, only the ping monitor profile is added.

- When assets are offboarded, these are similarly removed from the arbitrator.

PERFMON CUCM Group Profile	
Probe name	axlGetPerfmonCounters_CUCM_INTF (<CUCM Cluster name>)
Probe Group Name	<customer_name>-CUCM Perfmon AXL (<CUCM Cluster name>)
Frequency	600 sec (10 min)
For Publisher Server	Yes
For Subscriber Server	No

PERFMON CUC Group Profile	
Probe name	axlgetperfmon (<CUCxn Cluster name>)
Probe Group Name	<customer_name>-Cisco Unity AXL (<CUCxn Cluster name>)
Frequency	300 sec (5 min)
For Publisher Server	Yes
For Subscriber Server	No

RIS Group Profile	
Probe Group Name	1-Cisco CUCM RIS CmDevice_creds
Frequency	300 sec (5 min)
For Publisher Server	Yes
For Subscriber Server	No

PINGMON Group Profile	
Probe Group Name	1b-PING Monitor
Frequency	300 sec (5 min)
For Publisher Server	Yes
For Subscriber Server	Yes

VERSION Group Profile	
Probe Group Name	4-Cisco CUCM Version
Frequency	86400 sec (24 hr)
For Publisher Server	Yes
For Subscriber Server	No

RTMT Group Profile	
Probe Group Name	5-Cisco RTMT
Frequency	1800 sec (30 min)
For Publisher Server	Yes
For Subscriber Server	No

7.1.4. Onboard Voss Assurance Assets

New UC app onboarding

When *new* Unified CM and CUC servers are added in a cluster, the **Monitoring** details on the publisher servers show the list of available arbitrators under the **Assurance Arbitrator Server** check box instances. Select all the arbitrators to monitor the server.

See:

- [Set Up Cisco Unified Communications Manager Servers](#)
- [Set up Cisco Unity Connection.](#)

Note: The onboarding workflow transaction log also shows the updates and import of the Unified CM and CUC server service parameters.

The feature does not currently allow for the modification of any existing monitoring on UC Apps. Once a Unified CM or Unity Connection server is created, use the Onboard/Offboard Asset tools to enable/disable

monitoring.

Onboard Assets

If VOSS Assurance arbitrators are configured at a hierarchy, then for *existing* UC app (Unified CM and Unity Connection) clusters on VOSS-4-UC, the **Onboard Assets** menu provides for the management of the *clusters* and arbitrator servers *in a batch*.

1. Select **Onboard Assets**. You will be asked to choose a customer level hierarchy.
2. From the **Credential Type** drop down, keep the default `ADMIN` or choose a type. This determines which credential type of the UC server to use for asset configuration on the arbitrator.
3. Select clusters and arbitrators in **Available** transfer boxes and onboard by moving these to the **Selected** boxes.
4. Click **Save**.

All servers in a cluster are onboarded unless a server is already onboarded, in which case the the server is skipped. Inspect the Transaction Log to see the transactions and sub-transactions for each cluster.

Additional Tools to Onboard Single Cluster and Servers

A number of Views are available that are not exposed in the menu, but do have access profiles enabled for provider and higher level administrators, so that *single* assets can be onboarded. The views can be added to menus if needed:

- **Onboard Assurance Asset Cucm Server**
- **Onboard Assurance Asset Cuc Server**
- **Onboard Assurance Asset Cucm Cluster**
- **Onboard Assurance Asset Cuc Cluster**

These tools do not direct you to a particular hierarchy and the views allow you to carry out the tasks on the form by selecting:

- **Credential Type**
 - Cisco UCM/CUC Server or cluster
- **Arbitrator Server**

The views offer the same functionality as transfer boxes available on the **Onboard Assets** and **Offboard Assets** menus, but:

1. A user is not forced to a hierarchy
2. Tasks can be carried out for a shared architecture, for example if the cluster is located at a reseller hierarchy.

Onboard workflows

When a Unified CM or Unity Connection server (asset) is associated with a VOSS Assurance arbitrator, the following updates are made by VOSS-4-UC on the associated arbitrator.

The transactions for these can be seen on the transaction log.

Note: In the case of multiple server onboarding, the transaction log Action: Create Cucm App User may show a Status of Fail. This can be ignored, since duplicate user creation is ignored.

1. Create asset (the server)
2. Create (or update if not first asset) asset group (required by arbitrator)
 - One asset group is created per customer on VOSS-4-UC.
3. Create probes (performance monitoring): 5 probes are created - 4 generic and 1 customer-specific.
4. Create a probe group - see [Probes, Group Names, Profiles and Timings](#).
5. Create relevant credentials on Arbitrator - using the selected credential type user credentials set up on VOSS-4-UC.
 - These credentials are used to make the request to the asset, for example AXL user for Unified CM.
6. Create profiles in the VOSS Assurance arbitrator to tie together the items above: **Probe Group > Templates/Profiles**
 - See [Probes, Group Names, Profiles and Timings](#).
7. For Unified CM, service parameters for each server are updated:
 - a. setting up remote syslog
 - b. enable CDR and related settings
 - c. create the application user if this is a Publisher
8. If an update is made on an existing Unified CM, it is updated to show it is monitored by the arbitrator. The **Monitoring** details on the publisher servers show the list of available arbitrators and read-only enabled arbitrators that monitor the server.

The created assets, groups and profiles can be inspected on the integrated arbitrator interface. For details, see the VAA documentation.

7.1.5. Offboard Voss Assurance Assets

Unified CM- and Unity Connection Clusters that have been integrated with Assurance Arbitrator Servers are offboarded in two ways.

Note: While an asset can be offboarded, the feature does not currently allow for the *modification* of any existing monitoring on UC Apps.

Deleting the UC app

When a Unified CM or Unity connection server or cluster that was integrated with an arbitrator server is deleted, the asset, customer specific probes, profiles, credentials and related data are removed from the arbitrator. The VOSS-4-UC arbitrator data syncs for the UC app are also removed. See the Offboard workflows below.

Offboard Assets

The **Offboard Assets** menu provides for the removal of the *clusters* associations by arbitrator server *in a batch*.

1. Select **Offboard Assets**. You will be asked to choose a customer level hierarchy.
2. From the **Assurance Arbitrator Server** drop down, select the arbitrator to offboard assets.
3. Select assets currently associated with the arbitrator shown in **Available** transfer boxes. Offboarding is set by moving these to the **Selected** boxes.
4. Click **Save**.

Inspect the Transaction Log to see the transactions and sub-transactions.

Offboarded Unified CM and CUC servers in a cluster remain and show **Monitoring** details with specific **Assurance Arbitrator Server** instances disabled.

Additional Tool to Offboard Single Servers

A View is available that is not in the menu, but it has access profiles enabled for provider and higher level administrators, so that *single* assets can be offboarded. They can be added to menus if needed:

- **Offboard One Assurance Asset**

This tool allows you to carry out the tasks on the form by selecting:

- **Assurance Arbitrator Server**
- **Asset:** Cisco UCM/CUC Server

Offboard workflows

When a Unified CM or Unity Connection server (asset) is unassociated with a VAA Arbitrator, the following updates are made by VOSS-4-UC on the arbitrator.

The transactions for these can be seen on the transaction log.

1. Remove asset (the server)
2. Remove or refresh asset group
3. Remove probe (performance monitoring)
4. Remove probe group (customer specific) - see *Probes, Group Names, Profiles and Timings*
5. Remove relevant credentials on Arbitrator - by default the ADMIN user credentials set up on VOSS-4-UC
6. Remove profiles in VAA Arbitrator: **Probe Group > Templates/Profiles** - see *Probes, Group Names, Profiles and Timings*.
7. For Unified CM, remove the application user if this is a Publisher.

The UC app **Monitoring** details will show the arbitrators un-selected.

7.2. VOSS Phone Server Management

7.2.1. VOSS Phone Server Overview

The VOSS phone server provides a method of hosting SIP compliant devices such as phones and softclients where it is not possible or desirable to connect these devices into other vendor platforms.

In an HCS environment, full integration management is provided where all trunk and dialplan related configuration is automatically applied. Other CUCM dialplan designs may be utilised through the VOSS4UC dialplan additions templating feature.

The VOSS Phone Server provides three functions:

1. A SIP registrar allows the use of SIP devices from any compliant vendor, thereby allowing for a wide choice of phones with various feature sets, including the re-use of existing devices from systems such as Cisco Unified CM and others. Since the registrar requires only account definition per line, there is no phone concept in the Phone Server itself. Phones are represented in VOSS-4-UC and are a local construct only.
2. A SIP Switch handling SIP call traffic. Calls between phones hosted on the VOSS Phone Server are handled locally and calls to other extensions or PSTN destinations are offloaded over a SIP Trunk
3. Configuration File Management (Optional). Phone configuration files may be created and hosted in the VOSS Phone Server's tftp server. This allows unconfigured phones (i.e. new unused phones, or factory defaulted old phone stock) to obtain their configuration automatically when connected to the network.

Sample configuration files for phones from SNOM, Grandstream and Cisco are included.

VOSS-4-UC utilities include:

1. System setup and Country dialplan management
2. Evaluation of the number of re-usable Cisco CUM hosted phones
3. Conversion of Cisco configuration to phone server configuration

The VOSS Phone Server is deployed as an OVA, typically alongside CUCM Virtual Machines in an HCS/CUCM environment. Redundancy is an option, providing data replication between servers.

7.2.2. Managing VOSS Phone Servers

Adding phones requires three areas of configuration. These are all automated by VOSS-4-UC during the phone addition:

Set up call routing

In HCS mode, the CUCM dial plan is created to provide call routing of the chosen numbers towards VOSS Phone Server. This allows incoming call routing. Outbound calling Class of Service and routing are also configured to allow internal extension and E164 call routing. Number inventory and CLI management through transformation patterns are maintained.

1. Set up the VOSS Phone Server

VOSS Phone Servers are managed on the customer hierarchy - verify that you are at the customer hierarchy.

- **Version:** there is currently only 1.0.0 (base release version).
- **Deployment Mode:** two options are available:
 - HCS - VOSS-4-UC manages the Cisco CUCM dial plan and trunking, removing the need for manual integration. Use HCS to configure Unified CM call routing to the VOSS Phone server. Standard Cisco dial plan integration uses a dial plan templating facility. Other dial plans may be supported by creating custom dial plan templates suitable for the dial plan in use.
 - Standalone - manual integration with other call routing devices such as SBCs or other PBX and trunking services is required.
- If the HCS deployment mode is selected, the **HCS CUCM** must be selected.
- **Network Addresses:**
 - The SERVICE_PROVIDER_SPACE IPv4 address is the address as viewed from VOSS-4-UC, so could be an address viewed through NAT.
 - The APPLICATION_SPACE IPv4 addresses is the local address of the Phone Server in the customer network.

Both addresses are required, even where the address is the same as would be found if NAT was not in use to provide access from the service provider network.
- **Virtual Machine:** name is optional and is used for administrator data purposes. It is not used by VOSS-4-UC.

2. Add country support.

Country support must be added in HCS mode in order to integrate with the HCS dialplan. A template is required for each supported country. GBR and USA are provided by default, and other countries may be created or provided by VOSS as required.

To add HCS country support, use the “phone server countries” menu item and select the template for the required country. There are no user parameters required.

3. Configure the physical phone

In HCS mode, sites must be created with site dialplan and number inventory in the same way as when using Cisco Phones registered directly to CUCM. It is possible to host both CUCM and Phone Server phones at the same site.

The phone itself requires configuration in order to register and handle calls.

Soft clients will likely be manually configured locally on the hosting PC, and a “generic soft client” device type allows for locally configured devices.

Other hardware devices such as phones from SNOM, Cisco and Grandstream may be configured using configuration files hosted on the VOSS Phone Server and downloaded at start up by the phone. TFTP is used to download these files. VOSS Phone Server hosts such files for fully automated configuration of the device.

See:

- [VOSS Phones](#)
- [Adding phone types](#)

7.2.3. Adding phone types

New phone types (brands) can be created by creating a new phone type definition. This phone type defines behaviour of the Admin Portal when adding a phone, and defines sample configuration files and configuration templates to apply to this configuration file.

The sample file provides the layout of the phone configuration file but does not have values specific to each phone. Values such as the telephone number to apply are populated with a default value.

The configuration template allows access to any parameter in the sample file, and can be used to set the correct value for each phone, such as setting the telephone number. VOSS-4-UC has sample files and configuration for the SNOM D120 and D717 phones. This provides full configuration for these phones so that a new “out of the box” phone can be connected to the network and reach an operational state with no user intervention.

Adding a new phone type requires firstly creating a sample file. Many SNOM phones allow the export of the configuration which has been previously created through the phone web interface. This file can be used as the sample file, although values should be changed to make the file anonymous prior to uploading as a sample file. Once loaded, a configuration template can be created or cloned from the existing templates. This will allow modification of any value in the sample file, setting a value suitable for each phone. Using this technique, new phones types may be evaluated and added to VOSS4UC without the need for software updates or patches.

7.3. Conferencing Servers

7.3.1. WebEx Server

WebEx is a web conferencing facility used for collaboration with colleagues across your organization.

The support for Cisco WebEx is as follows:

- Hosted WebEx Cloud.
- Ability to create user accounts and meetings using WebEx versions:
 - 6.0 API and 27.00 server
 - 8.0 API and 29.13 server
- User and Meeting APIs are exposed and available, so that user capability can be managed. However, system setup, Site addition, and meeting functions, are done with the WebEx application.

Parameters are defined when adding WebEx instances of Network Devices on the Admin Portal.

WebEx Field Reference

Title	Field Type	Description
Type*	type	The type of WebEx server. It can be Cloud-Based .
Protocol*	protocol	The protocol that is used for communication with the WebEx server. The protocol can either be 'https' or 'http'.
Address*	address	The address of the WebEx server. For example, Site-name.webex.com.
Port	port	The port that is used for communication with the WebEx server.
Site Name	site_name	The name of the site to be managed. This name is typically the same as the start of the WebEx address. This field is mandatory if Site ID is not specified.
Site Id	site_id	An Id for the site being managed, typically received from the Cisco WebEx Site Provisioning group. This field is mandatory if Site Name is not specified.
Partner Id	partner_id	Partner ID typically received from the Cisco WebEx Site Provisioning group.
Partner Credentials	partner_credentials_override	Partner credentials to use for this set of connection parameters.
REST URI*	rest_uri	The relative URI of the XML service of the WebEx server. For example, WBXService/XMLService
WebEx	webex_id	The WebEx Id of an administrator of the site. This is used to connect to the server for administrative tasks such as adding or deleting users.
Email	email	A valid email for the administrator. Required if no WebEx Id is provided.
Password*	password	The password for the administrator with the supplied WebEx Id.
Version	version	Supported WebEx server versions. The supported server versions can either be '27.00' or '29.13'.

Device Model Mapping

A data model is maintained in VOSS-4-UC where its instances map network device types to data models. For example, the network device device/cucm would have a mapping to data/CallManager. These target data models are used to maintain network device data in VOSS-4-UC, and any of their default connection parameters.

Configure Cisco WebEx

This procedure adds and configures the server.

Note: For more information about conferencing, see [Conferencing: Overview](#).

1. Log in as provider or reseller administrator.
2. Choose **Device Management > WebEx > Servers**.
3. Click **Add**.
4. Complete, at minimum, the mandatory [WebEx Server Fields](#).
5. Click **Save**.
6. Test the connection to the WebEx server:
 - Select **Device Management > Advanced > WebEx Network Device**.
 - Click the WebEx server; then, choose **Action > Test Connection**.

WebEx Server Fields

Field	Description
Type *	WebEx server type. Read-only field set to Cloud-Based.
Protocol *	Protocol used to communicate with WebEx server. This field is mandatory and defaults to https.
Address *	The IP address or hostname of the WebEx server. This field is mandatory. Example: site-name.webex.com
Port	The port used to communicate with the WebEx Server. Defaults to 443.
Site Name	The name of the site to be managed. Usually matches the start of the WebEx address.
Site Id	An ID for the site being managed. Typically received from Cisco WebEx Site Provisioning group. Provide this field before testing the connection to the WebEx server.
Partner Id	Typically received from Cisco WebEx Site Provisioning group.
REST URI *	The relative URI for the XML service on the WebEx server. This field is mandatory and defaults to WBXService/XMLService.
WebEx Id	WebEx administrator ID. Either the WebEx Id or the Email field is mandatory.
Email	Email address of WebEx administrator. Either the WebEx Id or the Email field is mandatory.
Password	Password for the provided WebEx administrator. This field is mandatory.
Repeat Password	Confirm password for the provided WebEx administrator. This field is mandatory.
Version *	Supported WebEx version.

7.3.2. Set Up and Manage the Pexip Server

For an overview, see: [Pexip Conferencing Overview](#).

1. Log in as provider or reseller administrator.
2. Choose **Apps Management > Pexip Conferencing > Pexip Server**.
3. Click **Add**.
4. Complete, at minimum, the mandatory fields as in the field reference table.
5. Click **Save**.

Title	Field Type	Description
Server name*	name	The descriptive server name used to identify.
Description	description	Additional details to describe the server.
Host Name*	host	The host name or IP address of the server.
Version*	version	Version. Default: 1.0.0
User Name*	username	The administrator user name.
Password*	password	The password for the administrator.
Sync on Create/Update	sync	A full Pull Sync from the Pexip Server is run if enabled.

When a Pexip server is created, the following are also created:

- On the **Data Sync** menu:
 - A pull sync instance of data sync with the name format: *SyncPexip_<Pexip server name>*.
 - A purge sync instance of data sync with the name format: *PurgePexip_<Pexip server name>*.
- On the **Scheduling** menu:
 - An inactive schedule instance with the name format: *SchedulePexip_<Pexip server name>*.
When the schedule is set to be active, it executes the *SyncPexip_<Pexip server name>* pull data sync.
- To test the connection to the Pexip server, choose **Test Connection** action on the menu.
- To modify the server, select it and update the fields as needed.
- To delete the server, select it from the list and then select **Delete**.

Virtual Meeting Rooms are set up as a part of User management - see:

- [Set Up and Manage Pexip Virtual Meeting Rooms \(VMR\) and Conferencing](#)
- [Provision the Pexip Conference Service](#)

7.3.3. Zoom Server

Zoom is a web conferencing facility used for collaboration with colleagues across your organization.

The support for Cisco WebEx is as follows:

- Hosted WebEx Cloud.
- Ability to create user accounts and meetings using WebEx versions:
 - 6.0 API and 27.00 server
 - 8.0 API and 29.13 server
- User and Meeting APIs are exposed and available, so that user capability can be managed. However, system setup, Site addition, and meeting functions, are done with the WebEx application.

Parameters are defined when adding WebEx instances of Network Devices on the Admin Portal.

Zoom Field Reference

Title	Field Type	Description
Type*	type	The type of WebEx server. It can be Cloud-Based .
Protocol*	protocol	The protocol that is used for communication with the WebEx server. The protocol can either be 'https' or 'http'.
Address*	address	The address of the WebEx server. For example, Site-name.webex.com.
Port	port	The port that is used for communication with the WebEx server.
Site Name	site_name	The name of the site to be managed. This name is typically the same as the start of the WebEx address. This field is mandatory if Site ID is not specified.
Site Id	site_id	An Id for the site being managed, typically received from the Cisco WebEx Site Provisioning group. This field is mandatory if Site Name is not specified.
Partner Id	partner_id	Partner ID typically received from the Cisco WebEx Site Provisioning group.
Partner Credentials	partner_credentials_override	Partner credentials to use for this set of connection parameters.
REST URI*	rest_uri	The relative URI of the XML service of the WebEx server. For example, WBXService/XMLService
WebEx	webex_id	The WebEx Id of an administrator of the site. This is used to connect to the server for administrative tasks such as adding or deleting users.
Email	email	A valid email for the administrator. Required if no WebEx Id is provided.
Password*	password	The password for the administrator with the supplied WebEx Id.
Version	version	Supported WebEx server versions. The supported server versions can either be '27.00' or '29.13'.

Configure Zoom

This procedure adds and configures the server.

Note: For more information about conferencing, see [Conferencing: Overview](#).

1. Log in as provider or reseller administrator.
2. Choose **Device Management > WebEx > Servers**.
3. Click **Add**.
4. Complete, at minimum, the mandatory [WebEx Server Fields](#).
5. Click **Save**.
6. Test the connection to the WebEx server:
 - Select **Device Management > Advanced > WebEx Network Device**.
 - Click the WebEx server; then, select **Action > Test Connection**.

Zoom Server Fields

Field	Description
Type *	WebEx server type. Read-only field set to Cloud-Based.
Protocol *	Protocol used to communicate with WebEx server. This field is mandatory and defaults to https.
Address *	The IP address or hostname of the WebEx server. This field is mandatory. Example: site-name.webex.com
Port	The port used to communicate with the WebEx Server. Defaults to 443.
Site Name	The name of the site to be managed. Usually matches the start of the WebEx address.
Site Id	An ID for the site being managed. Typically received from Cisco WebEx Site Provisioning group. Provide this field before testing the connection to the WebEx server.
Partner Id	Typically received from Cisco WebEx Site Provisioning group.
REST URI *	The relative URI for the XML service on the WebEx server. This field is mandatory and defaults to WBXService/XMLService.
WebEx Id	WebEx administrator ID. Either the WebEx Id or the Email field is mandatory.
Email	Email address of WebEx administrator. Either the WebEx Id or the Email field is mandatory.
Password	Password for the provided WebEx administrator. This field is mandatory.
Repeat Password	Confirm password for the provided WebEx administrator. This field is mandatory.
Version *	Supported WebEx version.

8. Cisco Apps Management

8.1. CUCM (Cisco Unified Communications Manager)

8.1.1. Cisco Unified Communications Manager Configuration in VOSS-4-UC

Overview

Cisco Unified Communications Manager devices provide the core call processing capabilities for HCS, and are a critical part of the VOSS-4-UC provisioning workflows. You must configure the Unified CM devices before you complete the dial plan (if applicable), user, subscriber, line, and phone configuration.

Unified CM devices can be dedicated to a specific customer, or they can be shared between multiple customers. Unified CM devices must then be assigned to one or more Network Devices Lists (NDLs), and the NDL is then assigned to one or more sites. The NDL is used to select which Unified CM is used for configuration based on the site selected in the hierarchy context.

Shared versus Dedicated

To share the Unified CM across multiple customers, add the Unified CM at the Provider or Reseller level. To dedicate the Unified CM to a single customer, add the Unified CM at the Customer level.

When setting up Unified CM as a dedicated instance, you can opt to set up Unified CM after you create the customer.

Servers within a Cisco Unified Communications Manager Cluster

Within a Unified CM cluster, you can configure the following nodes:

- Cisco Unified Communications Manager Publisher
- Cisco Unified Communications Manager Subscriber
- IM and Presence Service Publisher
- IM and Presence Service Subscriber

Configure a Cisco Unified Communications Manager Publisher node before configuring any other type node.

Configure an IM and Presence Service Publisher node before configuring an IM and Presence Service Subscriber node.

Synchronization with VOSS-4-UC

Configuring a Unified CM device on VOSS-4-UC creates a scheduled data sync to import model data from the device into VOSS-4-UC. The scheduled data sync ensures that the VOSS-4-UC cache maintains the most current view of the configured device. Any changes to the configuration occurring on the device, including additions, deletions, or modifications, will be reflected in VOSS-4-UC after the next data sync.

Note:

- There is no immediate data sync upon Update or Modification.
- The scheduled data sync fails if the Unified CM administrator account credential has expired. Expiration of the administrator account credential can cause failures in Subscriber Management activities as well.
- Some license-related models will now be excluded from CUCM imports by default:
 - `device/cucm/LicensedUser`
 - `device/cucm/LicensingResourceUsage`
 - `device/cucm/HcsLicense`

The recurring sync is scheduled to occur every 14 days, but is disabled by default. You can enable the sync and modify the schedule from **Device Management > CUCM > Schedules**. When determining the appropriate schedule setting, the frequency of the sync must be weighed against the additional processing and network activity associated with the data sync. You can also manually run the data sync at any time from **Device Management > Advanced > Perform Publisher Actions**, or from **Administration Tools > Data Sync**.

Important: Allow the initial data sync to complete before doing more configuration on VOSS-4-UC that requires information from Unified CM.

When you set up an IM and Presence Service server, VOSS-4-UC does not communicate directly with the IM and Presence Service server. The information provided is pushed to HCM-F and Service Assurance (if installed) for monitoring purposes.

The performance of a data sync can be improved by controlling the types of data that are synced. See [Controlling a Data Sync with a Model Type List](#) for more information.

For details on Change Notification Sync in VOSS-4-UC and on switching between Full Sync and Change Notification Sync, refer to the topic on the Change Notification Feature (CNF) following [Change Notification Feature Overview](#).

Field Mappings in Unified CM

When setting up a Unified CM device with LDAP integration, you can map Unified CM user data to VOSS-4-UC user data for any field, based on the Field Mappings in the Unified CM server. These mappings are configured at the LDAP Directory in Unified CM. The mapped user data, for example location data, can later be used in a filter used to move users to sites.

On the Field Mappings tab, you can modify the mappings except for hard-coded mappings. Hard-coded mappings appear in gray and are read-only.

Note: The field name entered in the mapping on VOSS-4-UC must exactly match the field name entered in the mapping in the Unified CM in the Custom User Field Name field. If the field names do not match, the

field is skipped during the sync.

8.1.2. Set Up Cisco Unified Communications Manager Servers

This procedure configures Cisco Unified Communications Manager servers within a Unified CM cluster.

Note: References to HCM-F and Shared Data Repository (SDR) are only relevant if installed.

Perform these steps:

1. Log in as the appropriate hierarchy administrator.
Only a provider or reseller administrator can create a shared instance. A customer, provider, or reseller administrator can create a dedicated instance.
2. Set the hierarchy path to the correct level. Create a shared instance at the provider or reseller level. Create a dedicated instance at the customer level.
3. Choose **Device Management > CUCM > Servers**.
4. Click **Add**.
5. Enter the Unified CM server name in the **CUCM Server Name** field.

Note: A Unified CM server that has been configured in HCM-F and synced into VOSS-4-UC may exist at the sys.hcs hierarchy. If the server name you enter matches this server, the **Migrate from HCM-F to VOSS-4-UC** check box is displayed. Click **Save** to migrate this server to the current hierarchy level. The fields are populated with the values that were configured in HCM-F. If you do not want to migrate the server, enter a different server name.

6. From the **Server Type** drop-down, choose **Voice/Video**.
7. To configure a publisher node, select the **Publisher** check box.
On the **Publisher** tab, you can specify the following information:

Field	Description
Prime Collaboration	Choose the Prime Collaboration management application monitoring this cluster. To unassociate Prime Collaboration for this cluster, choose None .
Call Processing ID	The Call Processing ID of this cluster
SDR Cluster ID	The SDR CUCM cluster ID, as shown on SDR Configuration > SDR CUCM Clusters .
Multi-Tenant	Read-only field. If creating at provider level, this field is set to Shared. If creating at customer level, this field is set to Dedicated.
Version	Choose the version of the Unified CM Servers in this cluster. The available versions depend on the version of the HCM-F device that has been configured.
Port	The port on the Unified CM server to connect to. Default is 8443.
User Move Mode	Choose Automatic to automatically move synced in users to sites, based on the filters and filter order defined in User Management > Manage Filters . Choose Manual if you want an Administrator to manually move synced in users to a Site.
User Entitlement Profile	Choose the Entitlement Profile that specifies which devices and services users synced from this Unified CM are entitled to. Note: A violation of the Entitlement Profile does not prevent a user from being synced to VOSS-4-UC from Unified CM. However, subsequent updates to the user fail until the user's configuration satisfies the restrictions set in the Entitlement Profile.
Enable Change Notification Sync	Select this check box to enable Change Notification. By enabling this, a Change Notification data sync and corresponding Schedule will be created. The Schedule is initially created as Disabled and needs to be manually enabled from the Scheduling menu. The Change Notification Sync interval is set to 14 days by default. See the note below this table.
Monitoring	For new servers and if arbitrator servers are available, monitoring can be enabled for this Unified CM on VOSS Assurance. The arbitrator server check boxes can be selected to add the server as an asset. The arbitrator server will be updated. Existing servers can be managed from the Onboard Assets and Offboard Assets menus under VOSS Assurance. The arbitrator checkboxes will then reflect the asset status.

- For details on monitoring and VOSS Assurance and Analytics, refer to [VOSS Assurance Monitoring Overview](#).
- Refer to the topic on the Change Notification Feature (CNF) following [Change Notification Feature Overview](#).

8. For a Unified CM Publisher node, fill in the **Cluster Name** field with the name you want for this cluster. A new cluster is created with this name. This field is required. For Unified CM Subscribers, choose the Unified CM cluster from the **Cluster Name** drop-down menu.

9. Expand **Network Addresses**.

- Choose the SERVICE_PROVIDER_SPACE address space.
- The **Hostname** field is automatically populated with the Unified CM Server Name. Edit it if

necessary.

- c. Enter the IP address of the Cisco Unified Communications Manager Server in the **IPv4 Address** field. Note: Either the hostname or the IP address is required. Ensure that the hostname or IP address does not contain a trailing blank space. VOSS-4-UC cannot validate an entry that contains a blank space at the end of the hostname or IP address.
- d. Fill in the domain of the Unified CM application.
- e. Provide an optional description for the network address.

If NAT is used, also configure an APPLICATION_SPACE network address.

10. Expand **Credentials**.

- a. Add credentials for PLATFORM, ADMIN, HTTP, and SNMP_Vx credential types. Click + to add more credentials.
- b. Fill in the user ID and password that you configured when you installed the Unified CM.
- c. Choose RO (Read-only) or RW (Read or Write) for the Access Type. The default is RO.
- d. Provide an optional description for the credential.

ADMIN, HTTP, PLATFORM, and SNMP are required for PCA to manage Unified CM. PLATFORM and ADMIN are also required for Service Inventory to generate reports for UC applications.

Note:

- Expiration of the ADMIN account results in failed data syncs between Unified CM and VOSS-4-UC
 - The CUCM Admin Account requires the following roles (can be added in a group):
 - For normal AXL Add, Update, Delete transactions you need: *Standard AXL API Access*
 - For the Extension Mobility Login/Logout you need: *Standard EM Authentication Proxy Rights*
 - For querying the Phone Status via RIS API, uploading MOH files via GUI (Selenium Driver) and enabling Headset Service (also RIS API) you need: *Standard CCM Admin Users*
-

11. Inspect the default mappings and modify if required, see [User Field Mapping](#).
12. Click **Save**. A Unified CM network device is created in VOSS-4-UC. (If installed, a cluster and Unified CM are created in the SDR.)
13. Test the connection between Unified CM and VOSS-4-UC:
 - a. Choose **Device Management > Advanced > CUCM Network Device**.
 - b. Click the Unified CM you just added.
 - c. Choose **Action > Test Connection**.

If the test fails, and you used a hostname, make sure VOSS-4-UC has the correct DNS and Domain set.

- a. Log in to the platform CLI.
- b. Query the current DNS setting: **network dns**.
- c. Set the DNS if needed: **network dns <dns_server_ip_address>**.
- d. Query the current domain setting: **network domain**.
- e. Set the domain if needed: **network domain <domain>**.

Note:

Use the **CUCM Network Device** page only for testing the connection. Do not edit Unified CM from this page. To change any configuration of the Unified CM, edit it from the **Device Management > CUCM > Servers** page in VOSS-4-UC.

8.1.3. Clone an Instance of a Cisco Unified CM Device Model

To save time, make a copy of an existing instance of a device model rather than adding a new one. To do this, use the clone operation. When you create a clone, give it a new unique name and modify other device model fields as needed before saving.

Note: You can clone an instance of a device model to the same Cisco Unified CM or to a different Cisco Unified CM.

If you clone to a different Cisco Unified CM, make sure that all device model fields have values that are appropriate for the target Cisco Unified CM. For example, make sure calling search spaces specified in the source instance exist on the target Cisco Unified CM.

Perform these steps:

1. Log in as provider, reseller, or customer administrator.
2. Do one of the following:
 - If you logged in as provider or reseller administrator, choose **Apps Management > CUCM > {device_model_type}**.
 - If you logged in as customer administrator, choose **Apps Management > Advanced > {device_model_type}**.
3. From the device model list, click the instance to be cloned.
4. Click **Action > Clone**.
5. Depending on the device model, do one of the following:
 - When prompted, choose the NDL that contains the target Cisco Unified CM.
 - choose the target Cisco Unified CM from the **CUCM** drop-down menu.
6. Enter a unique name for the new instance of the device model in the **Name** field.
7. Modify other fields as required.

For more detailed information about the fields, see the corresponding topic on configuring a new instance of the device model. For example, if you are cloning a SIP trunk, see under [Configure SIP Trunks](#) for the SIP trunk field descriptions.
8. Click **Save** to save the cloned instance.

The new instance appears in the list. The new instance is created on the target Cisco Unified CM.

8.1.4. Headset Enablement

To enable the Cisco Headset Service for a Unified CM server listed under **Apps Management > CUCM > Servers**. Choose **Enable Services** from the **Action** menu.

A **Headset Enablement** menu option is also available to carry out this action by means of transfer boxes for all the **Available** servers in a **Call Manager Cluster**.

A data sync instance is also created for each server, in the format: *HcsPull-<host>-headset_models* that can be used to schedule a move of new Headset Inventory instances down to the matching user's hierarchy when it is run.

See: *Headset Management*.

8.1.5. Set Up IM and Presence Service Servers

This procedure configures IM and Presence Service servers within a Cisco Unified Communications Manager cluster.

Note: References to HCM-F and Shared Data Repository (SDR) are only relevant if installed.

Perform these steps:

1. Log in as the appropriate hierarchy administrator.
 - Only a provider or reseller administrator can create a shared instance. A customer, provider, or reseller administrator can create a dedicated instance.
2. Set the hierarchy path to the correct level. Create a shared instance at the provider or reseller level. Create a dedicated instance at the customer level.
3. Choose **Device Management > CUCM > Servers**.
4. Click **Add**.
5. Enter the IM and Presence Service server name in the **CUCM Server Name** field.
 - Note: An IM and Presence Service server that has been configured in HCM-F and synced into VOSS-4-UC may exist at the sys.hcs hierarchy. If the server name you enter matches this server, the **Migrate from HCM-F to VOSS-4-UC** check box is displayed. Click **Save** to migrate this server to the current hierarchy level. The fields are populated with the values that were configured in HCM-F. If you do not want to migrate the server, enter a different server name.
6. From the **Server Type** drop-down, choose **IM_P**.
7. To configure a publisher node, select the **Publisher** check box.
 - Note:
 - The **Publisher** tab is not populated for an IM and Presence Service publisher node.
8. Select the Cisco Unified Communications Manager cluster from the **Cluster Name** drop-down.
9. Expand **Network Addresses**.
 - a. Select the SERVICE_PROVIDER_SPACE address space.
 - b. The **Hostname** field is automatically populated with the IM and Presence Service Server Name. Edit it if necessary.

- c. Enter the IP address of the IM and Presence Service server in the **IPv4 Address** field.

Note: Either the hostname or the IP address is required. Ensure that the hostname or IP address does not contain a trailing blank space. VOSS-4-UC cannot validate an entry that contains a blank space at the end of the hostname or IP address.

- d. Fill in the domain of the IM and Presence Service application.
- e. Provide an optional description for the network address.

If NAT is used, also configure an APPLICATION_SPACE network address.

10. Expand **Credentials**.

- a. Add credentials for PLATFORM, ADMIN, HTTP, and SNMP_Vx credential types. Click + to add more credentials.
- b. Fill in the user ID and password that you configured when you installed the IM and Presence Service.
- c. Choose RO (Read-only) or RW (Read or Write) for the Access Type. The default is RO.
- d. Provide an optional description for the credential.

ADMIN, HTTP, PLATFORM, and SNMP are required for PCA to manage IM & Presence Service. PLATFORM and ADMIN are also required for Service Inventory to generate reports for UC applications.

11. Click **Save**.

8.1.6. CUP Cluster Migration

IM and Presence Service (previously known as CUP) was set up in a cluster separate from the Cisco Unified Communications Manager cluster. This configuration is called a multicluster configuration. However, the IM and Presence Service servers are set up as part of the Unified CM cluster itself, in what is called a single-cluster configuration. The single-cluster configuration correctly represents the Unified CM cluster with its IM and Presence Service servers in the management layer. This configuration eliminates the confusion that multicluster configurations can cause for administrators when Cisco Prime Collaboration Assurance and other tools show these servers in different clusters.

Multi-Cluster vs. Single Cluster Configuration

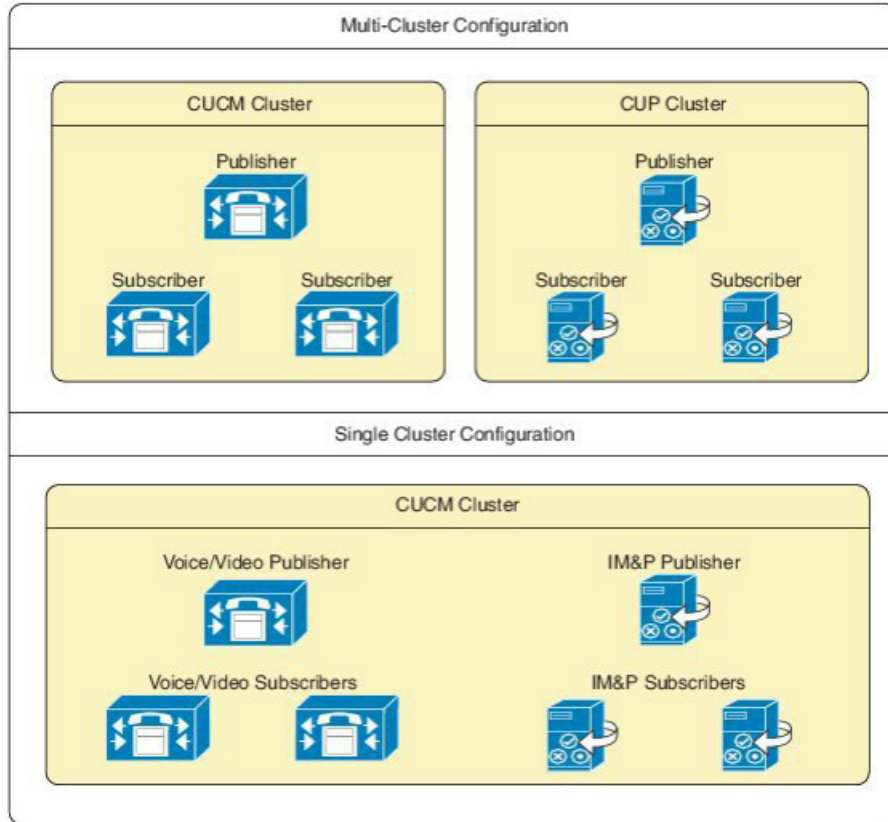

Although the use of multicluster configurations is deprecated and highly discouraged, VOSS-4-UC continues to support multicluster configurations for backward compatibility and upgrades. Service providers are encouraged to use the single-cluster configuration for new clusters. Convert existing multicluster configurations to single-cluster using the migration tool under Device Management.

8.1.7. Migrate CUP to a Cisco Unified CM Cluster

This tool migrates your CUP (also known as IM and Presence Service) nodes to a Cisco Unified Communications Manager cluster, which is the recommended configuration.

Migrating CUP nodes to a Unified CM cluster is hierarchy-specific. A Customer CUP node can only be migrated to a Customer Unified CM cluster and not to a Provider or Reseller cluster. A Publisher IM_P node is added first, then Subscriber nodes.

When migrating your CUP to a Unified CM cluster, the following conditions apply:

- Cluster versions must be the same for both the clusters.
- The IPv4 address or hostname and domain configuration must not be duplicated within the cluster.
- Two devices cannot have the same server name.
- No more than one CUP publisher can be migrated to the same Unified CM cluster.
- Multiple subscribers can be migrated to the same Unified CM cluster.

Perform these steps:

1. Log in as provider, reseller, or customer administrator, depending on the hierarchy level where the CUP cluster was configured.

2. Set the hierarchy path to the hierarchy node where the CUP cluster was configured. For a shared configuration, this would be a provider or reseller node. For a dedicated configuration, this would be a customer node.
3. Choose **Device Management > CUP (deprecated) > Migrate CUP to CUCM Cluster**.
4. From the **From CUP Cluster** drop-down menu, choose the CUP cluster you want to migrate.
5. From the **To CUCM Cluster** drop-down menu, choose the Unified CM cluster to which you want to migrate the CUP cluster.
6. Click **Save**.

The migrated CUP server is removed from the list under **Device Management > CUP > Servers** and now appears under **Device Management > CUCM > Servers** as server type **IM_P**. The cluster name for the migrated servers is now the same as the Unified CM cluster name.

8.1.8. Cisco Unified Communications Manager Server Deletion

Deleting a Cisco Unified Communications Manager Server in VOSS-4-UC also deletes local data that has been synced to it from the Cisco Unified Communications Manager Server, including:

- Users
- Configuration parameters
- Dial Plan Information (if applicable)

8.1.9. Configure Regions

This procedure adds or edits regions.

Regions can only be added at the customer or site hierarchy level but can be modified at any hierarchy level.

Regions added directly on Cisco Unified Communications Manager are synced in at the hierarchy level the Cisco Unified Communications Manager is configured at in VOSS-4-UC.

Perform these steps:

1. Log in as provider, reseller or customer administrator.
2. Choose **Device Management > CUCM > Regions**.
 - To add a new Region, click **Add**.
 - To edit an existing Region, click on the name of the Region to be updated.
4. From the **CUCM** drop-down menu, choose or modify the Cisco Unified Communications Manager that corresponds to the Region.
5. Enter a unique name for the new Region in the **Name** field, or modify the existing Name if desired.
6. In the **+ Related Regions** section, configure the following options:

Option	Description
Region Name	Drop-down menu with list of available regions. This field is mandatory.
Audio Codec Preference List	This is a drop-down containing available Audio Codec Preference Lists. The default codec is G.711.
Audio Bandwidth	Maximum Audio Bit Rate (kbps). This field is mandatory.
Video Bandwidth	Maximum Session Bit Rate for Video Calls (kbps). This field is mandatory.
Immersive Video Bandwidth	Maximum Session Bit Rate for Immersive Video Calls (kbps). This field is mandatory.

7. To save a new or updated group, click **Save**.

8.1.10. Delete Region

Regions can be deleted at any hierarchy level. Related regions cannot be removed from a region. They exist until either region is deleted.

Perform these steps:

1. Log in as provider, reseller or customer administrator.
2. Choose **Apps Management > CUCM > Regions**.
3. From the list of Regions, click the name of the Region to be deleted.
4. Click **Delete** on the button bar.
5. From the popup window, click **Yes** to confirm the deletion.

8.1.11. Softkey Templates

Introduction

Softkey templates manage softkeys that are used by the Cisco Unified CM IP Phones, for example 7970. There are two types of softkey templates:

- standard
- customized

VOSS-4-UC includes the following Unified CM system softkey templates, which cannot be modified or deleted:

- Cisco Assistant with Feature Hardkeys
- Cisco Chaperone Phone with Feature Hardkeys
- Cisco Feature with Feature Hardkeys Standard
- Cisco Manager with Feature Hardkeys Standard
- Cisco Protected Phone with Feature Hardkeys
- Cisco Shared Mode Manager with Feature Hardkeys
- Cisco User with Feature Hardkeys

- Personal Conference User
- Public Conference User
- Standard User

A reseller administrator (or higher) can create customized softkey templates from the standard templates, make modifications as required and save them at the required hierarchy level, i.e. customer or higher.

How to Manage Customized Softkey Templates and Related Softkey Layout Configurations

Note: The following device models need to be imported from Unified CM post upgrade before Softkey Templates can be managed.

This can be done by either performing a full import of Unified CM or using the “CUCM Softkey Templates” Model Type List which is available from Release 19.3.1. See: [Controlling a Data Sync with a Model Type List](#).

```
device/cucm/SoftKeyTemplate
device/cucm/SoftKey
device/cucm/SoftKeyCallState
device/cucm/SoftKeySet
```

-
1. Browse to the required hierarchy.
 2. Click **Add** to add a new customized softkey template.
 3. From the **Create a softkey template based on** drop-down, choose an existing softkey template on which to base the customized template.
 4. Enter a unique **Name** and **Description** for the customized template. The description can be a maximum of 50 characters but cannot include “, %, &, <, or >.”
 5. Select or clear the **Is Default** check box. If selected, this softkey template becomes the default standard softkey template.
 6. Click **Save** to save the customized softkey template and simultaneously add it to the **Softkey Template** list view.
 7. Select the newly created softkey template and configure the required softkey layout by modifying the designated softkeys for each call state.
 - a. CUCM baseline softkey templates cannot be updated. Any change to such a template will result in a failed transaction.
 - b. Some of the selected softkeys of the different call state are mandatory and cannot be removed from the CUCM standard set of templates. For example, template Standard User-Custom, Call State – On Hook, Softkey – NewCall.
- When a mandatory softkey is deleted, the transaction will be successful but the softkey will not be removed - when opening the template again it will still be there.
8. Click **Save** when complete.

Note: To modify a customized softkey template, select it from the **Softkey Template** list view and update as described in the above procedure.

Before deleting a softkey template, which has been marked as **Is Default**, a different softkey template must first be set as **Is Default**.

8.1.12. Call Park Management

Overview

Call Park Management

The Call Park feature (Call Park and Directed Call Park) allows you to manage call park numbers from the Call Park list.

Call Parks can be added either individually or in bulk using number ranges.

Multiple call park numbers can be added in a single operation, which creates the required number of individual call park numbers instead of creating masked ranges of 10, etc.

Call Park and Directed Call Park can be configured as either service specific or clusterwide, dependent on the status of the **Enable Clusterwide CallPark Number/Ranges** parameter on the Unified CM.

Call Park allows you to select directory numbers from a drop-down list, but also permits custom entries outside of the number inventory that can begin with '*' or '#', which are then added to the Number Inventory.

Note: Clusterwide call park numbers are available to devices hosted on any server within the Unified CM cluster. If clusterwide call park is disabled, the call park numbers are only available to devices on the nominated Unified CM server.

Clusterwide Call Park

Call Park allows users to place a call on hold, so it can be retrieved from another phone in the system, for example, a phone in another office or in a conference room.

If your users are on an active call at your phone, they can park the call to a call park extension by pressing the **Park** softkey or the **Call Park** button. Someone on another phone in your system can then dial the call park extension to retrieve the call.

You can define either a single directory number or a range of directory numbers for use as call park extension numbers. Users can park only one call at each call park extension number.

Clusterwide Directed Call Park

Directed Call Park allows a user to transfer a call to an available user-selected directed call park number.

Directed Call Park numbers are managed at site level, and allow a user to transfer a call to an available user-selected directed call park number. Configured directed call park numbers exist clusterwide. You can configure phones that support the directed call park Busy Lamp Field (BLF) to monitor the busy/idle status of specific directed call park numbers. Users can also use the BLF to speed dial a directed call park number.

Only one call can be parked at each directed call park number. To retrieve a parked call, a user must dial a configured retrieval prefix followed by the directed call park number at which the call is parked. Configure the retrieval prefix in the Directed Call Park Configuration window.

Note: Whenever changes are made to directed call park numbers, any devices that are configured to monitor those directed call park numbers by using the directed call BLF must restart to correct the display. Change

notification automatically restarts impacted devices when it detects directed call park number changes. You also can use the Restart Devices button on the Directed Call Park Configuration window.

Adding Call Parks

From the **Clusterwide Call Park** or **Clusterwide Directed Call Park** form (default access via **Device Management > CUCM > Clusterwide Call Park** or **Clusterwide Directed Call Park**):

1. Click **Add**.
2. Browse to the required Site level.
3. Enter, at minimum, the following mandatory fields:
 - Range Size* - Enter a range size of 1 or more.
 - First Call or Directed Call Park Number*
 - Displays call park numbers which are **not used** and **available**. If **Range Size** > 1, only contiguous ranges are made available.
 - Numbers beginning with '*' or '#' are allowed as free form numbers. However, numbers with this prefix cannot be created in the directory number inventory so directory number inventory management is not available.
 - Description - this description is used in the directory number inventory list view and also the Unified CM call park number.
 - Partition (Directed Call Park only) - The route partition of the directed call park range, selected from the drop-down list.
 - CUCM Server* - (Call Park only) - This field is mandatory, and a CUCM Server must be selected **IF** the **Enable Clusterwide CallPark Number/Ranges** parameter on the Unified CM is set to **False**.
 - Reversion Pattern (Directed Call Park only) - If a call is parked for longer than the allowed time, it reverts to the number selected from the drop-down list. Note that the allowed time is specified in the **Call Park Reversion Timer** parameter on the Unified CM.

Note: The **Enable Clusterwide CallPark Number/Ranges** and **Call Park Reversion Timer** parameters are located on the Unified CM under **System > Service Parameters - Service Parameter Configuration (Advanced) - Cisco CallManager (Active) Service > Clusterwide Parameters (Feature - General)** section.

- Revert CSS Name (Directed Call Park only) - This is the CSS that will be used to attempt to route the call to the reversion pattern above.
 - Retrieval Prefix* (Directed Call Park only) - for example, a '*' may be used to retrieve a number from the call park number.
4. Click **Save**.

8.1.13. Media Resources

VOSS-4-UC allows for the management of the following media resources in Unified CM:

- Media Termination Point (MTP)
- Transcoder
- Conference Bridge

Note:

- Resources may be added at customer and site level
 - In a multi cluster environment, Unified CM selection can be carried out for each resource.
 - A media resource with a device pool and/or location are usually set up at site level. If however the media resource is created at *customer level*, consider the configuration of the device pool / location at customer level. The use of defaults available at CUCM level is possible, but a review of these settings may be required. Alternatively, creating a specific device pool / location for the media resource may be a better option.
-

Media Termination Point

There is only support for the media termination point type:

- Cisco IOS Enhanced Software Media Termination Point

Add a MTP:

1. Navigate to the required customer or site level.
2. Select the Unified CM from the **CUCM** drop-down list.
3. Enter a **MTP Name**
4. Optionally complete the fields as required (refer to tooltips):
 - **Description**
 - **Mtp Type** - only one type supported: **Cisco IOS Enhanced Software Media Termination Point**. Display only.
 - **Device Pool Name** (refer to considerations at [Media Resources](#).)
 - **Trusted Relay Point**
5. Click **Save** and inspect the entry in the list view.

Note:

- **CUCM** is not available to be modified
 - The **MTP Name** cannot be modified
 - The **Mtp Type** cannot be modified
-

Use the **Delete** button to delete a MTP.

Transcoder

Add a Transcoder:

1. Navigate to the required customer or site level.
2. Select the Unified CM from the **CUCM** drop-down list.
3. The following transcoder types are supported in the **Product** drop-down list:
 - Cisco Media Termination Point Hardware
 - Cisco IOS Media Termination Point
 - Cisco IOS Enhanced Media Termination Point
4. Enter a **Transcoder Name**
5. Optionally complete the fields as required (refer to tooltips):

The device pool should reflect the physical position of the hardware.

- **Description**
- **Device Pool Name** (refer to considerations at [Media Resources.](#))
- **Is Trusted Relay Point**
- **Common Device Config Name** from Unified CM
- **Load Information**

6. Click **Save** and inspect the entry in the list view.

Note:

- **CUCM** is not available to be modified
 - The **Product** cannot be modified
 - The **Transcoder Name** cannot be modified
-

Use the **Delete** button to delete a transcoder.

Conference Bridge

The following transcoder types are supported:

Conference Bridges may be added updated and deleted.

Add a Conference Bridge:

1. Navigate to the required customer or site level.
2. Select the Unified CM from the **CUCM** drop-down list.
3. The following hardware types are supported in the **Product** drop-down list:
 - Cisco Conference Bridge Hardware
 - Cisco IOS Conference Bridge
 - Cisco IOS Enhanced Conference Bridge
4. Enter a **Conference Bridge Name**

5. Optionally complete the fields as required (refer to tooltips):

The device pool and location should reflect the physical position of the hardware.

- **Description**
- **Device Pool Name** (refer to considerations at [Media Resources](#).)
- **Location Name** - as available on Unified CM
- **Security Profile Name** - in accordance with the selected **Product**.
- **Common Device Config Name** from Unified CM
- **Use Trusted relay Point**

6. Click **Save** and inspect the entry in the list view.

Note: When *modifying* a Conference Bridge:

- **CUCM** is not available to be modified
 - The **Product** cannot be modified
 - The **Conference Bridge Name** cannot be modified
-

Use the **Delete** button to delete a Conference Bridge.

8.2. SIP Trunks

8.2.1. Configure SIP Trunks

This procedure adds new SIP trunks and edits existing SIP trunks.

Perform these steps:

1. Log in as provider, reseller, or customer administrator.
2. Set the hierarchy path to the node where the Cisco Unified Communications Manager is configured.
3. How are you logged in?
 - Provider or reseller administrator? Go to **Apps Management > CUCM > SIP Trunks**.
 - Customer administrator? Go to **Apps Management > Advanced > SIP Trunks**.
4. Do you want to ...
 - Add a new SIP trunk? Click **Add**, then go to Step 5.
 - Edit an existing SIP trunk? Click on the relevant SIP trunk in the list of SIP trunks; then, go to step 6.
5. From the **CUCM** drop-down menu, select the hostname, domain name, or IP address of the Unified CM where you want to add the SIP trunk.

Note: The **CUCM** drop-down displays only when you're adding a new SIP trunk (not when editing).

This drop-down menu displays the Unified CM located at the node, and all the Unified CM nodes in the hierarchies above the node where you're adding the SIP trunk.

To provision a Unified CM server, see the Installation Tasks section of Installing Cisco Unified Communications Manager.

6. In the **Device Name** field, enter a unique name for the new SIP trunk (or modify the existing device name, as applicable).
7. On the **Device Information** tab, complete at minimum, the mandatory *Device Information Tab*.
8. On the **Call Routing General** tab, complete at minimum, the mandatory *Call Routing General Tab*.
9. On the **Call Routing Inbound** tab, complete the required *Call Routing Inbound Tab*.
10. On the **Call Routing Outbound** tab, complete the required *Call Routing Outbound Tab*.
11. On the **SP Info** tab, complete the required *SP Info Tab*.
12. On the **GeoLocation** tab, complete at minimum, the mandatory *GeoLocation Tab*.
13. Click **Save** to save a new or updated SIP trunk.

The SIP trunk appears in the SIP trunk list. The SIP trunk is automatically reset on the Unified CM as soon as it's added. To reset the SIP trunk at any other time, see "Reset SIP Trunk".

To view the SIP trunk and its properties, log in to the Unified CM where you added the SIP trunk, select Device Trunk, and perform the "Find" operation. Clicking on the SIP trunk name in the list displays its characteristics.

Device Information Tab

Option	Description
Device Name *	Enter a unique identifier for the trunk using up to 50 alphanumeric characters: A-Z, a-z, numbers, hyphens (-) and underscores (_) only. Default value: None
Trunk Service Type	Choose one of: <ul style="list-style-type: none"> • None - Choose this option if the trunk is not used for call control discovery, Extension Mobility Cross Cluster, or Cisco Intercompany Media Engine • Call Control Discovery - Choose this option to enable the trunk to support call control discovery. • Extension Mobility Cross Cluster - Choose this option to enable the trunk to support the Extension Mobility Cross Cluster (EMCC) feature. Choosing this option causes the following settings to remain blank or clear and become unavailable for configuration, thus retaining their default values: Media Termination Point Required, Unattended Port, Destination Address, Destination Address IPv6, and Destination Address is an SRV. • Cisco Intercompany Media Engine - Ensure that the Cisco IME server is installed and available before you configure this field. • IP Multimedia Subsystem Service Control (ISC) - Choose this option to enable the trunk to support IP multimedia subsystem service control. Default value: None (Default)
Description (Optional)	Enter a descriptive name for the trunk using up to 114 characters in any language, but not including double-quotes ("), percentage sign (%), ampersand (&), backslash (\), or angle brackets (<>). Default value: empty
Device Pool *	Choose the appropriate device pool for the trunk. For trunks, device pools specify a list of Cisco Unified Communications Managers (Unified CMs) that the trunk uses to distribute the call load dynamically. Note: Calls that are initiated from a phone that is registered to a Unified CM that does not belong to the device pool of the trunk use different Unified CMs of this device pool for different outgoing calls. Selection of Unified CM nodes occurs in a random order. A call that is initiated from a phone that is registered to a Unified CM that does belong to the device pool of the trunk uses the same Unified CM node for outgoing calls if the Unified CM is up and running. Default value: Default
Common Device Configuration	Choose the common device configuration to which you want this trunk assigned. The common device configuration includes the attributes (services or features) that are associated with a particular user. Default value: None
Call Classification	This parameter determines whether an incoming call through this trunk is considered off the network (OffNet) or on the network (OnNet). When the Call Classification field is configured as Use System Default, the setting of the Unified CM clusterwide service parameter, Call Classification, determines whether the trunk is OnNet or OffNet. This field provides an OnNet or OffNet alerting tone when the call is OnNet or OffNet, respectively. Default value: Use System Default

Option	Description
Media Resource Group List	<p>This list provides a prioritized grouping of media resource groups. An application chooses the required media resource, such as a Music On Hold server, from among the available media resources according to the priority order that a Media Resource Group List defines.</p> <p>Default value: None</p>
Location *	<p>Use locations to implement call admission control (CAC) in a centralized call-processing system. CAC enables you to regulate audio quality and video availability by limiting the amount of bandwidth that is available for audio and video calls over links between locations. The location specifies the total bandwidth that is available for calls to and from this location.</p> <p>Choose the appropriate location for this trunk:</p> <ul style="list-style-type: none"> • Hub_None - Specifies that the locations feature does not keep track of the bandwidth that this trunk consumes. • Phantom - Specifies a location that enables successful CAC across intercluster trunks that use H.323 protocol or SIP. • Shadow - Specifies a location for intercluster enhanced location CAC. Valid for SIP intercluster trunks (ICT) only. <p>Default value: Hub_None</p>
AAR Group	<p>Choose the automated alternate routing (AAR) group for this device. The AAR group provides the prefix digits that are used to route calls that are otherwise blocked due to insufficient bandwidth. An AAR group setting of None specifies that no rerouting of blocked calls is attempted.</p> <p>Default value: None</p>
Tunneled Protocol	<p>Choose the QSIG option if you want to use SIP trunks or SIP gateways to transport (tunnel) QSI messages from Unified CM to other PINXs. QSIG tunneling supports the following features: Call Back, Call Completion, Call Diversion, Call Transfer, Identification Services, Path Replacement, and Message Waiting Indication (MWI).</p> <p>Note: Remote-Party-ID (RPID) headers coming in from the SIP gateway can interfere with QSIG content and cause unexpected behavior with Call Back capabilities. To prevent interference with the QSIG content, turn off the RPID headers on the SIP gateway.</p> <p>Default value: None</p>
QSIG Variant	<p>To display the options in the QSIG Variant drop-down list, choose QSIG from the Tunneled Protocol drop-down menu. This parameter specifies the protocol profile that is sent in outbound QSIG facility information elements.</p> <p>From the drop-down menu, select one of:</p> <ul style="list-style-type: none"> • No Changes - Default. Keep this parameter set to the default value unless a VOSS support engineer instructs otherwise. • Not Selected • ECMA - Select for ECMA PBX systems that use Protocol Profile 0x91 • ISO - Select for PBX systems that use Protocol Profile 0x9F <p>Default value: No Changes</p>

Option	Description
ASN.1 ROSE OID Encoding	<p>To display the options in the ASN.1 ROSE OID Encoding drop-down menu, choose QSIG from the Tunneled Protocol drop-down menu. This parameter specifies how to encode the Invoke Object ID (OID) for remote operations service element (ROSE) operations.</p> <p>From the drop-down menu, select one of</p> <ul style="list-style-type: none"> • No Changes - Keep this parameter set to the default value unless a VOSS support engineer instructs otherwise. • Not Selected • Use Global Value ECMA - If you selected the ECMA option from the QSIG Variant drop-down menu, select this option. • Use Global Value ISO - If you selected the ISO option from the QSIG Variant drop-down menu, select this option. • Use Local Value <p>Default value: No Changes</p>
Packet Capture Mode	<p>This setting exists for troubleshooting encryption only; packet capturing may cause high CPU usage or call-processing interruptions.</p> <p>From the drop-down menu, select one of:</p> <ul style="list-style-type: none"> • None - This option, which serves as the default setting, indicates that no packet capturing is occurring. After you complete packet capturing, configure this setting. • Batch Processing Mode - Unified CM writes the decrypted or nonencrypted messages to a file, and the system encrypts each file. On a daily basis, the system creates a new file with a new encryption key. Unified CM, which stores the file for seven days, also stores the keys that encrypt the file in a secure location. Unified CM stores the file in the PktCap virtual directory. A single file contains the time stamp, source IP address, source IP port, destination IP address, packet protocol, message length, and the message. The TAC debugging tool uses HTTPS, administrator username and password, and the specified day to request a single encrypted file that contains the captured packets. Likewise, the tool requests the key information to decrypt the encrypted file. Before you contact TAC, you must capture the SRTP packets by using a sniffer trace between the affected devices. <p>Default value: None</p>
Packet Capture Duration	<p>This setting exists for troubleshooting encryption only; packet capturing may cause high CPU usage or call-processing interruptions. This field specifies the maximum number of minutes that is allotted for one session of packet capturing.</p> <p>To initiate packet capturing, enter a value other than 0 in the field. After packet capturing completes, the value, 0, displays.</p> <p>Default value: 0 (zero), Range is from 0 to 300 minutes</p>

Option	Description
Media Termination Point Required	<p>You can configure Unified CM SIP trunks to always use an Media Termination Point (MTP). Select this box to provide media channel information in the outgoing INVITE request. When this check box is selected, all media channels must terminate and reoriginate on the MTP device. If you clear the check box, the Unified CM can decide whether calls are to go through the MTP device or be connected directly between the endpoints.</p> <p>Note: If the check box remains clear, Unified CM attempts to dynamically allocate an MTP if the DTMF methods for the call legs are not compatible. For example, existing phones that run SCCP support only out-of-band DTMF, and existing phones that run SIP support RFC2833. Because the DTMF methods are not identical, the Unified CM dynamically allocates an MTP. If, however, a new phone that runs SCCP, which supports RFC2833 and out-of band, calls an existing phone that runs SIP, Unified CM does not allocate an MTP because both phones support RFC2833. So, by having the same type of DTMF method supported on each phone, there is no need for MTP.</p> <p>Default value: False (Cleared)</p>
Retry Video Call as Audio	<p>This check box pertains to outgoing SIP trunk calls and does not impact incoming calls. By default, the system selects this check box to specify that this device should immediately retry a video call as an audio call (if it cannot connect as a video call) prior to sending the call to call control for rerouting. If you clear this check box, a video call that fails to connect as video does not try to establish as an audio call. The call then fails to call control, and call control routes the call using Automatic Alternate Routing (AAR) and route list or hunt list.</p> <p>Default value: True (Selected)</p>
Path Replacement Support	<p>This check box is relevant when you select QSIG from the Tunneled Protocol drop-down menu. This setting works with QSIG tunneling to ensure that non-SIP information gets sent on the leg of the call that uses path replacement.</p> <p>Default value: False (Clear)</p>
Transmit UTF-8 for Calling Party Name	<p>This device uses the user locale setting of the device pool to determine whether to send unicode and whether to translate received Unicode information. For the sending device, if you select this check box and the user locale setting in the device pool matches the terminating phone user locale, the device sends unicode. If the user locale settings do not match, the device sends ASCII. The receiving device translates incoming unicode characters based on the user locale setting of the sending device pool. If the user locale setting matches the terminating phone user locale, the phone displays the characters.</p> <p>Note: The phone may display malformed characters if the two ends of the trunk are configured with user locales that do not belong to the same language group.</p> <p>Default value: False (Cleared)</p>

Option	Description
Transmit UTF-8 Names for QSIG APDU	<p>This device uses the user locale setting of the device pool to determine whether to send unicode and whether to translate received Unicode information. For the sending device, if you select this check box and the user locale setting in the device pool matches the terminating phone user locale, the device sends unicode and encodes in UTF-8 format. If the user locale settings do not match, the device sends ASCII and encodes in UTF-8 format. If the configuration parameter is not set and the user locale setting in the device pool matches the terminating phone user locale, the device sends unicode (if the name uses 8 bit format) and encodes in ISO8859-1 format.</p> <p>Default value: False (Cleared)</p>
Unattended Port	<p>Select this check box if calls can be redirected and transferred to an unattended port, such as a voice mail port.</p> <p>Default value: False (Cleared)</p>
SRTP Allowed	<p>Select this check box if you want Unified CM to allow secure and nonsecure media calls over the trunk. Selecting this check box enables Secure Real-Time Protocol (SRTP) SIP Trunk connections and also allows the SIP trunk to fall back to Real-Time Protocol (RTP) if the endpoints do not support SRTP. If you do not select this check box, Unified CM prevents SRTP negotiation with the trunk and uses RTP negotiation instead.</p> <p>Caution:</p> <p>If you select this check box, we strongly recommend that you use an encrypted TLS profile, so that keys and other security related information do not get exposed during call negotiations. If you use a non-secure profile, SRTP still works but the keys get exposed in signaling and traces. In that case, you must ensure the security of the network between Unified CM and the destination side of the trunk.</p> <p>Default value: False (Cleared)</p>
Consider Traffic on This Trunk Secure	<p>This field provides an extension to the existing security configuration on the SIP trunk, which enables a SIP trunk call leg to be considered secure if SRTP is negotiated, independent of the signaling transport.</p> <p>From the drop-down menu, select one of:</p> <ul style="list-style-type: none"> • When using both sRTP and TLS • When using sRTP Only - Displays when you select the SRTP Allowed check box. <p>Default value: When using both sRTP and TLS</p>

Option	Description
Route Class Signaling Enabled	<p>From the drop-down menu, enable or disable route class signaling for the port. Route class signaling communicates special routing or termination requirements to receiving devices. It must be enabled for the port to support the Hotline feature.</p> <p>From the drop-down menu, select one of:</p> <ul style="list-style-type: none"> • Default - The device uses the setting from the Route Class Signaling service parameter • Off - Enables route class signaling. This setting overrides the Route Class Signaling service parameter • On - Disables route class signaling. This setting overrides the Route Class Signaling service parameter. <p>Default value: Default</p>
Use Trusted Relay Point	<p>From the drop-down menu, enable or disable whether Unified CM inserts a trusted relay point (TRP) device with this media endpoint. A Trusted Relay Point (TRP) device designates an MTP or transcoder device that is labeled as Trusted Relay Point. Unified CM places the TRP closest to the associated endpoint device if more than one resource is needed for the endpoint (for example, a transcoder or RSVPAgent). If both TRP and MTP are required for the endpoint, TRP gets used as the required MTP. If both TRP and RSVPAgent are needed for the endpoint, Unified CM first tries to find an RSVPAgent that can also be used as a TRP. If both TRP and transcoder are needed for the endpoint, Unified CM first tries to find a transcoder that is also designated as a TRP.</p> <p>Select one of:</p> <ul style="list-style-type: none"> • Default - The device uses the Use Trusted Relay Point setting from the common device configuration with which this device associates • Off - Disables the use of a TRP with this device. This setting overrides the Use Trusted Relay Point setting in the common device configuration with which this device associates. • On - Enables the use of a TRP with this device. This setting overrides the Use Trusted Relay Point setting in the common device configuration with which this device associates. <p>Default value: Default</p>
PSTN Access	<p>If you use the Cisco Intercompany Media Engine feature, select this check box to indicate that calls made through this trunk might reach the PSTN. Select this check box even if all calls through this trunk device do not reach the PSTN. For example, select this check box for tandem trunks or an H.323 gatekeeper routed trunk if calls might go to the PSTN. When selected, this check box causes the system to create upload voice call records (VCRs) to validate calls made through this trunk device.</p> <p>Default value: True (Selected)</p>
Run On All Active Unified CM Nodes	<p>Select this check box to enable the trunk to run on every node.</p> <p>Default value: False (Cleared)</p>

Call Routing General Tab

Option	Description
Remote-Party-ID	<p>Use this check box to allow or disallow the SIP trunk to send the Remote-Party-ID (RPID) header in outgoing SIP messages from Unified CM to the remote destination. If you select this box, the SIP trunk always sends the RPID header. If you do not select this check box, the SIP trunk does not send the RPID header.</p> <p>Note:</p> <p>Be aware that Calling Name Presentation, Connected Line ID, and Connected Name Presentation are not available when QSIG tunneling is enabled.</p> <p>Outgoing SIP Trunk Calls</p> <p>The configured values of the Calling Line ID Presentation and Calling Name Presentation provide the basis for the construction of the Privacy field of the RPID header. Each of these two options can have the values of Default, Allowed, or Restricted. If either option is set to Default, the corresponding information (Calling Line ID Presentation and/or Calling Name Presentation) in the RPID header comes from the Call Control layer (which is based on call-by-call configuration) within Unified CM. If either option is set to Allowed or Restricted, the corresponding information in the RPID header comes from the SIP trunk configuration window.</p> <p>Incoming SIP Trunk Calls</p> <p>The configured values of the Connected Line ID Presentation and Connected Name Presentation provide the basis for the construction of the Privacy field of the RPID header. Each of these two options can have the values of Default, Allowed, or Restricted.</p> <p>Be aware that the Connected Line ID Presentation and Connected Name Presentation options are relevant for 180/200 messages that the SIP trunk sends in response to INVITE messages that Unified CM receives. If either option is set to Default, the corresponding information (Connected Line ID Presentation and/or Connected Name Presentation) in the RPID header comes from the Call Control layer (which is based on call-by-call configuration) within Unified CM. If either option is set to Allowed or Restricted, the corresponding information in the RPID header comes from the SIP trunk configuration window.</p> <p>Note:</p> <p>The Remote-party ID and Asserted Identity options represent independent mechanisms for communication of display-identity information.</p> <p>Default value: True (Selected)</p>

Option	Description
Asserted-Identity	<p>Use this check box to allow or disallow the SIP trunk to send the Asserted-Type and SIP Privacy headers in SIP messages. If you select this check box, the SIP trunk always sends the Asserted-Type header; whether or not the SIP trunk sends the SIP Privacy header depends on the SIP Privacy configuration.</p> <p>Outgoing SIP Trunk Calls - P Headers The decision of which Asserted Identity (either P-Asserted Identity or P-Preferred-Identity) header gets sent depends on the configured value of the Asserted-Type option. A non-default value for Asserted-Type overrides values that come from Unified CM Call Control. If the Asserted-Type option is set to Default, the value of Screening Identification that the SIP trunk receives from Unified CM Call Control dictates the type of Asserted-Identity.</p> <p>Outgoing SIP Trunk Calls - SIP Privacy Header The SIP Privacy header gets used only when you select the Asserted-Identity check box and when the SIP trunk sends either a Privacy-Asserted Identity (PAI) or Privacy Preferred Identity (PPI) header. (Otherwise the SIP Privacy header neither gets sent nor processed in incoming SIP messages). The value of the SIP Privacy headers depends on the configured value of the SIP Privacy option. A non-default value for SIP Privacy overrides values that come from Unified CM Call Control.</p> <p>If the SIP Privacy option is set to Default, the Calling Line ID Presentation and Calling Name Presentation that the SIP trunk receives from Unified CM Call Control determines the SIP Privacy header.</p> <p>Incoming SIP Trunk Calls - P Headers The decision of which Asserted Identity (either P-Asserted Identity or P-Preferred-Identity) header gets sent depends on the configured value of the Asserted-Type option. A non-default value for Asserted-Type overrides values that come from Unified CM Call Control. If the Asserted-Type option is set to Default, the value of Screening Identification that the SIP trunk receives from Unified CM Call Control dictates the type of Asserted-Identity.</p> <p>Incoming SIP Trunk Calls - SIP Privacy Header The SIP Privacy header gets used only when you select the Asserted Identity check box and when the SIP trunk sends either a PAI or PPI header. (Otherwise the SIP Privacy header neither gets sent nor processed in incoming SIP messages.) The value of the SIP Privacy headers depends on the configured value of the SIP Privacy option. A non-default value for SIP Privacy overrides values that come from Unified CM Call Control.</p> <p>If the SIP Privacy option is set to Default, the Connected Line ID Presentation and Connected Name Presentation that the SIP trunk receives from Unified CM Call Control determine the SIP Privacy header.</p> <p>Note: The Remote-party ID and Asserted Identity options represent independent mechanisms for communication of display-identity information. Default value: True (Selected)</p>

Option	Description
Asserted-Type	<p>From the drop-down menu, select one of the following values to specify the type of Asserted Identity header that SIP trunk messages should include:</p> <ul style="list-style-type: none"> • Default - Screening information that the SIP trunk receives from Unified CM Call Control determines the type of header that the SIP trunk sends. • PAI - The Privacy-Asserted Identity header gets sent in outgoing SIP trunk messages; this value overrides the Screening indication value that comes from Unified CM. • PPI - The Privacy Preferred Identity header gets sent in outgoing SIP trunk messages; this value overrides the Screening indication value that comes from Unified CM. <p>Note: These headers get sent only if the Asserted- Identity check box is selected. Default value: Default</p>
SIP Privacy	<p>From the drop-down menu, select one of the following values to specify the type of SIP privacy header for SIP trunk messages to include:</p> <ul style="list-style-type: none"> • Default - This option represents the default value; Name/Number Presentation values that the SIP trunk receives from the Unified CM Call Control compose the SIP Privacy header. For example, if Name/Number presentation specifies Restricted, the SIP trunk sends the SIP Privacy header; however, if Name/Number presentation specifies Allowed, the SIP trunk does not send the Privacy header. • None - The SIP trunk includes the Privacy:none header and implies Presentation allowed; this value overrides the Presentation information that comes from Unified CM. • ID - The SIP trunk includes the Privacy:id header and implies Presentation restricted for both name and number; this value overrides the Presentation information that comes from Unified CM. • ID Critical - The SIP trunk includes the Privacy:id;critical header and implies Presentation restricted for both name and number. The label critical implies that privacy services that are requested for this message are critical, and, if the network cannot provide these privacy services, this request should get rejected. This value overrides the Presentation information that comes from Unified CM. <p>Note: These headers get sent only if the Asserted Identity check box is selected. Default value: Default</p>

Call Routing Inbound Tab

Option	Description
Significant Digits	<p>Significant digits represent the number of final digits that are retained on inbound calls. Use for the processing of incoming calls and to indicate the number of digits that are used to route calls that are coming in to the SIP device.</p> <p>Choose the number of significant digits to collect, from 0 to 32, or choose 99 to indicate all digits.</p> <p>Note: Unified CM counts significant digits from the right (last digit) of the number that is called.</p> <p>Default value: 99</p>
Connected Line ID Presentation	<p>Unified CM uses connected line ID presentation (COLP) as a supplementary service to provide the calling party with the connected party number. The SIP trunk level configuration takes precedence over the call-by-call configuration. Select one of</p> <ul style="list-style-type: none"> • Default - Allowed. Choose Default if you want Unified CM to send connected line information. If a call that originates from an IP phone on Unified CM encounters a device, such as a trunk, gateway, or route pattern, that has the Connected Line ID Presentation set to Default, the presentation value is automatically set to Allowed. • Restricted - Choose Restricted if you do not want Unified CM to send connected line information. <p>Note: Be aware that this service is not available when QSIG tunneling is enabled.</p> <p>Default value: Default</p>
Connected Name Presentation	<p>Unified CM uses connected name ID presentation (CONP) as a supplementary service to provide the calling party with the connected party name. The SIP trunk level configuration takes precedence over the call-by-call configuration. Select one of</p> <ul style="list-style-type: none"> • Default - Allowed. Choose Default if you want Unified CM to send connected name information. • Restricted - Choose Restricted if you do not want Unified CM to send connected name information. <p>Note: Be aware that this service is not available when QSIG tunneling is enabled.</p> <p>Default value: Default</p>
Calling Search Space	<p>From the drop-down menu, choose the appropriate calling search space for the trunk. The calling search space specifies the collection of route partitions that are searched to determine how to route a collected (originating) number. You can configure the number of items that display in this drop-down menu by using the Max List Box Items enterprise parameter. If more calling search spaces exist than the Max List Box Items enterprise parameter specifies, the Find button displays next to the drop-down list box. Click the Find button to display the Find and List Calling Search Spaces window. Find and choose a calling search space name.</p> <p>Note: To set the maximum list box items, choose System > Enterprise Parameters and choose CCAdmin Parameters.</p> <p>Default value: None</p>

Option	Description
AAR Calling Search Space	Choose the appropriate calling search space for the device to use when performing automated alternate routing (AAR). The AAR calling search space specifies the collection of route partitions that are searched to determine how to route a collected (originating) number that is otherwise blocked due to insufficient bandwidth. Default value: None
Prefix DN	Enter the prefix digits that are appended to the called party number on incoming calls. Unified CM adds prefix digits after first truncating the number in accordance with the Significant Digits setting. You can enter the international escape character +. Default value: None
Redirecting Diversion Header - Delivery In-bound	Select this check box to accept the Redirecting Number in the incoming INVITE message to the Unified CM. Clear the check box to exclude the Redirecting Number in the incoming INVITE message to the Unified CM. You use Redirecting Number for voice messaging integration only. If your configured voice-messaging system supports Redirecting Number, you should select the check box. Default value: False (Cleared)
Incoming Calling Party - Prefix	Unified CM applies the prefix that you enter in this field to calling party numbers that use Unknown for the Calling Party Numbering Type. You can enter up to 8 characters, which include digits, the international escape field, you cannot configure the Strip Digits field. In this case, Unified CM takes the configuration for the Prefix and Strip Digits fields from the device pool that is applied to the device. If the word, Default, displays in the Prefix field in the Device Pool Configuration window, Unified CM applies the service parameter configuration for the incoming calling party prefix, which supports both the prefix and strip digit functionality. Default value: None
Incoming Calling Party - Strip Digits	Enter the number of digits, up to the number 24, that you want Unified CM to strip from the calling party number of Unknown type before it applies the prefixes. Default value: None
Incoming Calling Party - Calling Search Space	This setting allows you to globalize the calling party number of Unknown calling party number type on the device. Make sure that the calling party transformation CSS that you choose contains the calling party transformation pattern that you want to assign to this device. Before the call occurs, the device must apply the transformation by using digit analysis. If you configure the CSS as None, the transformation does not match and does not get applied. Ensure that you configure the calling party transformation pattern in a non-null partition that is not used for routing. Default value: None

Option	Description
Incoming Calling Party - Use Device Pool CSS	Select this check box to use the calling search space for the Unknown Number field that is configured in the device pool that is applied to the device. Default value: True (Selected)
Incoming Called Party - Prefix	Unified CM applies the prefix that you enter in this field to called numbers that use Unknown for the Called Party Number Type. You can enter up to 16 characters, which include digits, the international escape character (+), asterisk (*), or the pound sign (#). You can enter the word, Default, instead of entering a prefix. Tip: If the word Default displays in the Prefix field, you cannot configure the Strip Digits field. In this case, Unified CM takes the configuration for the Prefix and Strip Digits fields from the device pool that is applied to the device. If the word Default displays in the Prefix field in the Device Pool Configuration window, Unified CM does not apply any prefix or strip digit functionality. Default value: None
Incoming Called Party - Strip Digits	Enter the number of digits that you want Unified CM to strip from the called party number of Unknown type before it applies the prefixes. Tip: To configure the Strip Digits field, you must leave the Prefix field blank or enter a valid configuration in the Prefix field. To configure the Strip Digits fields in these windows, do not enter the word, Default, in the Prefix field. Default value: None
Incoming Called Party - Calling Search Space	This setting allows you to transform the called party number of Unknown called party number type on the device. If you choose None, no transformation occurs for the incoming called party number. Make sure that the calling search space that you choose contains the called party transformation pattern that you want to assign to this device. Default value: None
Incoming Called Party - Use Device Pool CSS	Select this check box to use the calling search space for the Unknown Number field that is configured in the device pool that is applied to the device. Default value: True (Selected)

Option	Description
Connected Party Transformation CSS	<p>This setting is applicable only for inbound calls. This setting allows you to transform the connected party number on the device to display the connected number in another format, such as a DID or E164 number. Unified CM includes the transformed number in the headers of various SIP messages, including 200 OK and mid-call update and reinvite messages. Make sure that the Connected Party Transformation CSS that you choose contains the connected party transformation pattern that you want to assign to this device.</p> <p>Note: If you configure the Connected Party Transformation CSS as None, the transformation does not match and does not get applied. Ensure that you configure the Calling Party Transformation pattern used for Connected Party Transformation in a non-null partition that is not used for routing.</p> <p>Default value: None</p>
Use Device Pool Connected Party Transformation CSS	<p>To use the Connected Party Transformation CSS that is configured in the device pool that is assigned to this device, select this check box. If you do not select this check box, the device uses the Connected Party Transformation CSS that you configured for this device in the Trunk Configuration window.</p> <p>Default value: True (Selected)</p>

Call Routing Outbound Tab

Option	Description
Called Party Transformation CSS	<p>This setting allows you to send the transformed called party number in an INVITE message for outgoing calls made over SIP Trunk. Make sure that the Called Party Transformation CSS that you choose contains the called party transformation pattern that you want to assign to this device.</p> <p>Note: If you configure the Called Party Transformation CSS as None, the transformation does not match and does not get applied. Ensure that you configure the Called Party Transformation CSS in a non-null partition that is not used for routing.</p> <p>Default value: None</p>
Use Device Pool Called Party Transformation CSS	<p>To use the Called Party Transformation CSS that is configured in the device pool that is assigned to this device, select this check box. If you do not select this check box, the device uses the Called Party Transformation CSS that you configured for this device in the Trunk Configuration window.</p> <p>Default value: True (Selected)</p>
Calling Party Transformation CSS	<p>This setting allows you to send the transformed calling party number in an INVITE message for outgoing calls made over a SIP Trunk. Also when redirection occurs for outbound calls, this CSS is used to transform the connected number that is sent from Unified CM side in outgoing reINVITE / UPDATE messages. Make sure that the Calling Party Transformation CSS that you choose contains the calling party transformation pattern that you want to assign to this device.</p> <p>Tip: If you configure the Calling Party Transformation CSS as None, the transformation does not match and does not get applied. Ensure that you configure the Calling Party Transformation Pattern in a non-null partition that is not used for routing.</p> <p>Default value: None</p>
Use Device Pool Calling Party Transformation CSS	<p>To use the Calling Party Transformation CSS that is configured in the device pool that is assigned to this device, select this check box. If you do not select this check box, the device uses the Calling Party Transformation CSS that you configured in the Trunk Configuration window.</p> <p>Default value: True (Selected)</p>
Calling Party Selection	<p>Choose the directory number that is sent on an outbound call. Select one of the following options to specify which directory number is sent:</p> <ul style="list-style-type: none"> • Originator - Send the directory number of the calling device • First Redirect Number - Send the directory number of the redirecting device. • Last Redirect Number - Send the directory number of the last device to redirect the call. • First Redirect Number (External) - Send the external directory number of the redirecting device • Last Redirect Number (External) - Send the external directory number of the last device to redirect the call. <p>Default value: Originator</p>

Option	Description
Calling Line ID Presentation	<p>Unified CM uses calling line ID presentation (CLIP) as a supplementary service to provide the calling party number. The SIP trunk level configuration takes precedence over the call-by-call configuration.</p> <p>Select one of</p> <ul style="list-style-type: none"> • Default - Allowed. Choose Default if you want Unified CM to send calling number information. • Restricted - Choose Restricted if you do not want Unified CM to send the calling number information. <p>Default value: Default</p>
Calling Name Presentation	<p>Unified CM used calling name ID presentation (CNIP) as a supplementary service to provide the calling party name. The SIP trunk level configuration takes precedence over the call-by-call configuration.</p> <p>Select one of</p> <ul style="list-style-type: none"> • Default - Allowed. Choose Default if you want Unified CM to send calling name information. • Restricted - Choose Restricted if you do not want Unified CM to send the calling name information. <p>Note: This service is not available when QSIG tunneling is enabled.</p> <p>Default value: Default</p>
Calling and Connected Party Info Format *	<p>This option allows you to configure whether Unified CM inserts a directory number, a directory URI, or a blended address that includes both the directory number and directory URI in the SIP identity headers for outgoing SIP messages.</p> <p>From the drop-down menu, select one of:</p> <ul style="list-style-type: none"> • Deliver DN only in connected party - In outgoing SIP messages, Unified CM inserts the calling party - s directory number in the SIP contact header information. • Deliver URI only in connected party, if available - In outgoing SIP messages, Unified CM inserts the sending party - s directory URI in the SIP contact header. If a directory URI is not available, Unified CM inserts the directory number instead. • Deliver URI and DN in connected party, if available - In outgoing SIP messages, Unified CM inserts a blended address that includes the calling party's directory URI and directory number in the SIP contact headers. If a directory URI is not available, Unified CM includes the directory number only. <p>Note: You should set this field to Deliver URI only in connected party or Deliver URI and DN in connected party only if you are setting up URI dialing between Unified CM systems of Release 9.0 or greater, or between a Cisco Unified Communications Manager system of Release 9. 0 or greater and a third party solution that supports URI dialing. Otherwise, you must set this field to Deliver DN only in connected party.</p> <p>Default value: Deliver DN only in connected party</p>

Option	Description
Redirecting Diversion Header Delivery - Outbound	<p>Select this check box to include the Redirecting Number in the outgoing INVITE message from the Unified CM to indicate the original called party number and the redirecting reason of the call when the call is forwarded.</p> <p>Clear the check box to exclude the first Redirecting Number and the redirecting reason from the outgoing INVITE message. Use Redirecting Number for voice-messaging integration only. If your configured voice messaging system supports Redirecting Number, select the check box.</p> <p>Default value: False (Cleared)</p>
Use Device Pool Redirecting Party Transformation CSS	<p>Select this check box to use the Redirecting Party Transformation CSS that is configured in the device pool that is assigned to this device.</p> <p>If you do not select this check box, the device uses the Redirecting Party Transformation CSS that you configured for this device (see field below).</p>
Redirecting Party Transformation CSS	<p>Allows you to localize the redirecting party number on the device.</p> <p>Make sure that the Redirecting Party Transformation CSS that you enter contains the redirecting party transformation pattern that you want to assign to this device.</p>
Caller Information - Caller ID DN	<p>Enter the pattern, from 0 to 24 digits that you want to use to format the Called ID on outbound calls from the trunk. For example, in North America:</p> <ul style="list-style-type: none"> • 55XXXX = Variable Caller ID, where X represents an extension number. The Central Office (CO) appends the number with the area code if you do not specify it. • 555000 = Fixed Caller ID. Use this form when you want the Corporate number to be sent instead of the exact extension from which the call is placed. The CO appends the number with the area code if you do not specify it. <p>You can also enter the international escape character +.</p> <p>Default value: None</p>
Caller Information - Caller Name	<p>Enter a caller name to override the caller name that is received from the originating SIP Device.</p> <p>Default value: None</p>
Caller Information - Maintain Original Caller ID DN and Caller Name in Identity Headers	<p>This check box is used to specify whether you will use the caller ID and caller name in the URI outgoing request. If you select this check box, the caller ID and caller name is used in the URI outgoing request. If you do not select this check box, the caller ID and caller name is not used in the URI outgoing request.</p> <p>Default value: False (Cleared)</p>

SP Info Tab

Option	Description
Destination Address is an SRV	This field specifies that the configured Destination Address is an SRV record. Default value: False (Cleared)
Destination - Destination Address IPv4	<p>The Destination Address IPv4 represents the remote SIP peer with which this trunk will communicate. The allowed values for this field are an IP address, a fully qualified domain name (FQDN), or DNS SRV record only if the Destination Address is an SRV field is selected.</p> <p>Tip: For SIP trunks that can support IPv6 or IPv6 and IPv4 (dual stack mode), configure the Destination Address IPv6 field in addition to the Destination Address field.</p> <p>Note: SIP trunks only accept incoming requests from the configured Destination Address and the specified incoming port that is specified in the SIP Trunk Security Profile that is associated with this trunk.</p> <p>Note: For configuring SIP trunks when you have multiple device pools in a cluster, you must configure a destination address that is a DNS SRV destination port. Enter the name of a DNS SRV port for the Destination Address and select the Destination Address is an SRV Destination Port check box. If the remote end is a Unified CM cluster, DNS SRV represents the recommended choice for this field. The DNS SRV record should include all Unified CMs within the cluster.</p> <p>Default value: None</p>
Destination - Destination Address IPv6	<p>The Destination IPv6 Address represents the remote SIP peer with which this trunk will communicate. You can enter one of the following values in this field:</p> <ul style="list-style-type: none"> • A fully qualified domain name (FQDN) • A DNS SRV record, but only if the Destination Address is an SRV field is selected. <p>SIP trunks only accept incoming requests from the configured Destination IPv6 Address and the specified incoming port that is specified in the SIP Trunk Security Profile that is associated with this trunk.</p> <p>If the remote end is a Unified CM cluster, consider entering the DNS SRV record in this field. The DNS SRV record should include all Unified CMs within the cluster.</p> <p>Tip: For SIP trunks that run in dual-stack mode or that support an IP Addressing Mode of IPv6 Only, configure this field. If the SIP trunk runs in dual-stack mode, you must also configure the Destination Address field.</p> <p>Default value: None. If IPv4 field above is completed, this field can be left blank.</p>
Destination - Destination port	<p>Choose the destination port. Ensure that the value that you enter specifies any port from 1024 to 65535, or 0.</p> <p>Note: You can now have the same port number that is specified for multiple trunks. You do not need to enter a value if the destination address is a DNS SRV port. The default 5060 indicates the SIP port.</p> <p>Default value: 5060</p>

Option	Description
Sort Order *	Indicate the order in which the prioritize multiple destinations. A lower sort order indicates higher priority. This field requires an integer value. Default value: Empty
Destination Address is an SRV	This field specifies that the configured Destination Address is an SRV record. Default value: False (Cleared)
Destination - Destination Address IPv4	<p>The Destination Address IPv4 represents the remote SIP peer with which this trunk will communicate. The allowed values for this field are an IP address, a fully qualified domain name (FQDN), or DNS SRV record only if the Destination Address is an SRV field is selected.</p> <p>Tip: For SIP trunks that can support IPv6 or IPv6 and IPv4 (dual stack mode), configure the Destination Address IPv6 field in addition to the Destination Address field.</p> <p>Note: SIP trunks only accept incoming requests from the configured Destination Address and the specified incoming port that is specified in the SIP Trunk Security Profile that is associated with this trunk.</p> <p>Note: For configuring SIP trunks when you have multiple device pools in a cluster, you must configure a destination address that is a DNS SRV destination port. Enter the name of a DNS SRV port for the Destination Address and select the Destination Address is an SRV Destination Port check box.</p> <p>If the remote end is a Unified CM cluster, DNS SRV represents the recommended choice for this field. The DNS SRV record should include all Unified CMs within the cluster.</p> <p>Default value: None</p>
Destination - Destination Address IPv6	<p>The Destination IPv6 Address represents the remote SIP peer with which this trunk will communicate. You can enter one of the following values in this field:</p> <ul style="list-style-type: none"> • A fully qualified domain name (FQDN) • A DNS SRV record, but only if the Destination Address is an SRV field is selected. <p>SIP trunks only accept incoming requests from the configured Destination IPv6 Address and the specified incoming port that is specified in the SIP Trunk Security Profile that is associated with this trunk.</p> <p>If the remote end is a Unified CM cluster, consider entering the DNS SRV record in this field. The DNS SRV record should include all Unified CMs within the cluster.</p> <p>Tip: For SIP trunks that run in dual-stack mode or that support an IP Addressing Mode of IPv6 Only, configure this field. If the SIP trunk runs in dual-stack mode, you must also configure the Destination Address field.</p> <p>Default value: None. If IPv4 field above is completed, this field can be left blank.</p>

Option	Description
Destination - Destination port	<p>Choose the destination port. Ensure that the value that you enter specifies any port from 1024 to 65535, or 0.</p> <p>Note:</p> <p>You can now have the same port number that is specified for multiple trunks. You do not need to enter a value if the destination address is a DNS SRV port. The default 5060 indicates the SIP port.</p> <p>Default value: 5060</p>
Sort Order *	<p>Indicate the order in which the prioritize multiple destinations. A lower sort order indicates higher priority. This field requires an integer value.</p> <p>Default value: Empty</p>
MTP Preferred Originating Codec	<p>Indicate the preferred outgoing codec by selecting one of:</p> <ul style="list-style-type: none"> • 711ulaw • 711alaw • G729/G729a • G729b/G729ab <p>Note:</p> <p>To configure G.729 codecs for use with a SIP trunk, you must use a hardware MTP or transcoder that supports the G.729 codec.</p> <p>This field is used only when the Media Termination Point Required check box is selected on the Device Information tab.</p> <p>Default value: 711ulaw</p>
BLF Presence Group *	<p>Configure this field with the Presence feature. From the drop-down menu, select a Presence group for the SIP trunk. The selected group specifies the destinations that the device/application/server that is connected to the SIP trunk can monitor.</p> <ul style="list-style-type: none"> • Standard Presence group is configured with installation. Presence groups that are configured in Unified CM Administration also appear in the drop-down menu. • Presence authorization works with presence groups to allow or block presence requests between groups. <p>Tip:</p> <p>You can apply a presence group to the SIP trunk or to the application that is connected to the SIP trunk. If a presence group is configured for both a SIP trunk and SIP trunk application, the presence group that is applied to the application overrides the presence group that is applied to the trunk.</p> <p>Default value: Standard Presence Group</p>

Option	Description
SIP Trunk Security Profile *	<p>Select the security profile to apply to the SIP trunk. You must apply a security profile to all SIP trunks that are configured in Unified CM Administration. Installing Cisco Unified Communications Manager provides a predefined, nonsecure SIP trunk security profile for autoregistration. To enable security features for a SIP trunk, configure a new security profile and apply it to the SIP trunk. If the trunk does not support security, choose a nonsecure profile.</p> <p>Default value: Non Secure SIP Trunk Profile</p>
Rerouting Calling Search Space	<p>Calling search spaces determine the partitions that calling devices can search when they attempt to complete a call. The rerouting calling search space gets used to determine where a SIP user (A) can refer another user (B) to a third party (C). After the refer is completed, B and C connect. In this case, the rerouting calling search space that is used is that of the initial SIP user (A). Calling Search Space also applies to 3xx redirection and INVITE with Replaces features.</p> <p>Default value: None</p>
Out-Of-Dialog Refer Calling Search Space	<p>Calling search spaces determine the partitions that calling devices can search when they attempt to complete a call. The out-of-dialog calling search space gets used when a Unified CM refers a call (B) that is coming into SIP user (A) to a third party (C) when no involvement of SIP user (A) exists. In this case, the system uses the out-of dialog calling search space of SIP user (A).</p> <p>Default value: None</p>
SUBSCRIBE Calling Search Space	<p>Supported with the Presence feature, the SUBSCRIBE calling search space determines how Unified CM routes presence requests from the device/server/application that connects to the SIP trunk. This setting allows you to apply a calling search space separate from the call-processing search space for presence (SUBSCRIBE) requests for the SIP trunk.</p> <p>From the drop-down menu, choose the SUBSCRIBE calling search space to use for presence requests for the SIP trunk. All calling search spaces that you configure in Unified CM Administration display in the SUBSCRIBE Calling Search Space drop-down menu.</p> <p>If you do not select a different calling search space for the SIP trunk from the drop-down menu, the SUBSCRIBE calling search space defaults to None.</p> <p>To configure a SUBSCRIBE calling search space specifically for this purpose, configure a calling search space as you do all calling search spaces.</p> <p>Default value: None</p>
SIP Profile *	<p>From the drop-down list box, select the SIP profile that is to be used for this SIP trunk.</p> <p>Default value: Standard SIP Profile</p>

Option	Description
DTMF Signaling Method	<p>Select one of:</p> <ul style="list-style-type: none"> • No Preference - Unified CM picks the DTMF method to negotiate DTMF, so the call does not require an MTP. If Cisco Unified Communications Manager has no choice but to allocate an MTP (if the Media Termination Point Required check box is selected on the Device Information tab), SIP trunk negotiates DTMF to RFC2833. • RFC 2833 - Choose this configuration if the preferred DTMF method to be used across the trunk is RFC2833. Unified CM makes every effort to negotiate RFC2833, regardless of MTP usage. Out of band (OOB) provides the fallback method if the peer endpoint supports it. • OOB and RFC 2833 - Choose this configuration if both out of band and RFC2833 should be used for DTMF. <p>Note: If the peer endpoint supports both out of band and RFC2833, Unified CM negotiates both out-of-band and RFC2833 DTMF methods. As a result, two DTMF events are sent for the same DTMF keypress (one out of band and the other, RFC2833). Default value: No Preference</p>
Normalization Script	<p>From the drop-down menu, choose the script that you want to apply to this trunk. To import another script, on Unified CM go to the SIP Normalization Script Configuration window (Device > Device Settings > SIP Normalization Script), and import a new script file. Default value: None</p>
Normalization Script - Enable Trace	<p>Select this check box to enable tracing within the script or clear the check box to disable tracing. When selected, the trace.output API provided to the Lua scripiter produces SDI trace. Note: We recommend that you only enable tracing while debugging a script. Tracing impacts performance and should not be enabled under normal operating conditions. Default value: False (Cleared)</p>
Script Parameters	<p>Enter parameter names and values in the format Param1Name=Param1Value; Param2Name=Param2Value where Param1Name is the name of the first script parameter and Param1Value is the value of the first script parameter. Multiple parameters can be specified by putting semicolon after each name and value pair . Valid values include all characters except equal signs (=), semi-colons (;); and non-printable characters, such as tabs. You can enter a parameter name with no value.</p>
Recording Information	<p>Enter one of</p> <ul style="list-style-type: none"> • 0 - None (default) • 1 - This trunk connects to a recording-enabled gateway • 2 - This trunk connects to other clusters with recording-enabled gateways

GeoLocation Tab

Option	Description
Geolocation	From the drop-down list box, choose a geolocation. You can choose the Unspecified geolocation, which designates that this device does not associate with a geolocation. On Unified CM, you can also choose a geolocation that has been configured with the System > Geolocation Configuration menu option. Default value: None
Geolocation Filter	From the drop-down menu, choose a geolocation filter. If you leave the <None> setting, no geolocation filter gets applied for this device. On Unified CM, you can also choose a geolocation filter that has been configured with the System > Geolocation Filter menu option. Default value: None
Send Geolocation Information	Select this check box to send geolocation information for this device. Default value: False (Cleared)

8.2.2. Delete SIP Trunks

Perform these steps:

1. Log in as provider, reseller or customer administrator.
2. Perform one of:
 - If you logged in as provider or reseller administrator, choose **Apps Management > CUCM > SIP Trunks**.
 - If you logged in as customer administrator, choose **Apps Management > Advanced > SIP Trunks**.
3. From the list of trunks, choose the SIP trunk to be deleted, by clicking on its box in the leftmost column.
4. Click **Delete** to delete the SIP trunk.
5. From the popup window, click **Yes** to confirm the deletion.

8.2.3. Reset SIP Trunks

This procedure shuts down a SIP trunk and brings it back into service. This procedure does not physically reset the hardware; it only reinitializes the configuration that is loaded by the Cisco Unified Communications Manager cluster. To restart a SIP trunk without shutting it down, use Restart SIP Trunks.

Perform these steps:

1. Log in as provider, reseller or customer administrator.
2. Perform one of:
 - If you logged in as provider or reseller administrator, choose **Device Management > CUCM > SIP Trunks**.
 - If you logged in as customer administrator, choose **Device Management > Advanced > SIP Trunks**.

3. From the list of SIP trunks, click the SIP trunk to be reset, then choose **Action > Reset**.

8.2.4. Restart SIP Trunks

This procedure restarts a SIP trunk without shutting it down first.

Note:

- To shut down a SIP trunk prior to the reset, see [Reset SIP Trunks](#).
- If the SIP trunk is not registered with Cisco Unified Communications Manager, you cannot restart it.

Warning: Restarting a SIP trunk drops all active calls that are using the trunk.

Perform these steps:

1. Log in as provider, reseller or customer administrator.
2. Choose an option:
 - If you logged in as provider or reseller administrator, choose **Device Management > CUCM > SIP Trunks**.
 - If you logged in as customer administrator, choose **Device Management > Advanced > SIP Trunks**.
3. From the list of trunks, click the SIP trunk to be restarted, then click **Action > Restart**.

8.3. Route Groups

8.3.1. Configure Route Groups

This procedure adds or modifies route groups.

Prerequisites:

You must define one or more gateway or SIP trunks before you add a route group.

A route group allows you to designate the order in which gateways are selected. It allows you to prioritize a list of gateways and ports for outgoing trunk selection.

For example, if you use two long distance carriers, you could add a route group so that long distance calls to the less expensive carrier are given priority. Calls only route to the more expensive carrier if the first trunk is unavailable.

Note: Each gateway or gateway and port combination can only belong to one route group and can only be listed once within that route group. All gateways in a route group must have the same route pattern. The pattern is assigned to the route list containing the route group (not the route group itself).

Route groups are optional. If a proposed route group only contains one gateway or one gateway and port combination and that route group is not to be included in a route list, the route group is not needed.

Perform the following steps:

1. Log in as provider, reseller or customer administrator.
2. Perform one of:
 - If you logged in as provider or reseller administrator, choose **Apps Management > CUCM > Route Groups**.
 - If you logged in as customer administrator, choose **Apps Management > Advanced > Route Groups**.
3. Do you want to ..
 - Add a new route group? Click **Add**.
 - Edit an existing route group? Click the group to be updated, edit the fields as required, then click **Save** to save the edited route group.
4. From the **CUCM** drop-down menu, choose or modify the Cisco Unified Communications Manager that corresponds to the route group.
5. Enter a unique name for the new route group in the **Route Group Name** field, or modify the existing Route Group Name if desired. The name can comprise up to 50 alphanumeric characters and can contain any combination of spaces, period(s), hyphens (-), and underscore characters (_). Ensure that each route group name is unique to the route plan.

Tip:

Use concise and descriptive names for the route group. The CompanynameLocationGroup format usually provides a sufficient level of detail and is short enough to enable you to quickly and easily identify a route group. For example, - CiscoDallasAA1 - identifies a Cisco Access Analog route group for the Cisco office in Dallas.

6. From the drop-down menu, select or modify the Distribution Algorithm options for the route group. Default value is Circular.

Option	Description
Top Down	Select this option if you want Cisco Unified Communications Manager to distribute a call to idle or available members starting with the first idle or available member of a route group to the last idle or available member of a route group. Note: You need to select Top Down to prioritize the order of devices in Step 10.
Circular	Chose this option if you want Cisco Unified Communications Manager to distribute a call to idle or available members starting from the (n+1)th member of a route group, where the nth member is the member to which the Cisco Unified Communications Manager most recently extended a call. If the nth member is the last member of a route group, Cisco Unified Communications Manager distributes a call starting from the top of the route group.

7. Click + to open the **Members** box. Perform one or more of the following steps:
 - To add a device to the route group, perform Step 8.
 - To modify the priority of a device, go to Step 10.
 - To remove a device from the route group, go to Step 11.
8. To add a device to the route group:

- a. From the **Device Name** drop-down menu, choose the device where the route group is added.
Note:
When a SIP trunk or gateway is added, all ports on the device are selected.
- b. For Device Selection Order, indicate the order in which to prioritize multiple devices. A lower selection order indicates higher priority. This field requires an integer value. The default is no setting. The device selection order, if specified, overrides the position of the device in the list.
9. To add another device to the route group, click + at the top of the **Members** box, then repeat Steps 8 and 9 for each additional device.
10. If no device selection order is specified, you can change the priority of a device by moving the device up or down in the list by clicking the arrows on the right side of the **Members** box. Using the Up arrow, move the device higher in the list to make it a higher priority in the route group, or using the Down arrow, move the device lower in the list to make it a lower priority in the route group.
Note: The Top Down distribution algorithm must be selected in Step 6 to prioritize the order of devices.
11. To remove a device from the route group, select the device in the Members box and click the - on the right side of the **Members** box.
Note:
You must leave at least one device in the route group.
12. To save a new or updated route group, click **Save**. The route group appears in the **Route Group** list.

8.3.2. Delete Route Groups

Perform these steps:

1. Log in as provider, reseller or customer administrator.

Warning: When deleting a route group, ensure that you select a valid site under your customer in the hierarchy node breadcrumb at the top of the view. If you attempt to delete a route group at any other node in the hierarchy, you will receive an error indicating that you must be at a site.

2. Choose an option:
 - If you logged in as provider or reseller administrator, choose **Apps Management > CUCM > Route Groups**.
 - If you logged in as customer administrator, choose **Apps Management > Advanced > Route Groups**.
3. From the list of trunks, choose the route group to be deleted, by clicking on its check box in the leftmost column. The Route Group profile appears.
4. Click **Delete** to delete the Route Group.
5. From the popup window, click **Yes** to confirm the deletion.

8.4. Route Lists

8.4.1. Configure Route Lists

Before You Begin

Configure route groups before performing this procedure.

Route lists are made up of route groups and are associated with route patterns. A route list associates a set of route groups with a route pattern and determines the order in which those route groups are accessed. The order controls the progress of the search for available trunk devices for outgoing calls.

A route list can contain only route groups. Each route list should have at least one route group. Each route group includes at least one device, such as a gateway, that is available. Based on device type, Cisco Unified Communications Manager (Unified CM) can choose some, or all, ports as resources in each route group. Some devices, such as digital access, only allow you to choose all ports.

You can add a route group to any number of route lists.

Use the following procedure to add route lists or to add, remove or change the order of route groups in a route list.

Procedure

1. Log in to as provider, reseller or customer administrator.

Note: When configuring a route list as a provider or reseller, ensure that you select a valid customer or site under your customer in the hierarchy node breadcrumb at the top of the view.

2. Perform one of the following:

- If you logged in as provider or reseller administrator, choose **Device Management > CUCM > Route Lists**.
- If you logged in as customer administrator, choose **Device Management > Advanced > Route Lists**.

3. Perform one of:

- To add a new route list, click **Add**, then go to Step 4.
- To edit an existing route list, choose the list to be updated by clicking on its box in the leftmost column, then click **Edit** to update the selected route list. Go to Step 5.

4. Complete at minimum, the mandatory *Route Lists Details Fields*.

5. To add a route group to this route list, click + on the right side of the **Route Group Items** box and complete at minimum, the mandatory *Route Group Items Fields*.

6. To remove a route group from this route list, click - on the right side of its row in the **Member** box.

7. To change the priority of a route group, move it up or down in the list by clicking the arrows on the right side of the **Member** box. Using the Up arrow, move the group higher in the list to make it a higher priority, or using the Down arrow, move the group lower in the list to make it a lower priority.

8. To save a new or updated route list, click **Save**.

Route Lists Details Fields

Field	Description
CUCM *	Select a Unified CM for the route list. This field is mandatory.
Name *	<p>Enter a unique name for the new route list. The name can contain up to 50 alphanumeric characters and can contain any combination of spaces, period(s), hyphens (-), and underscore characters (_). This field is mandatory.</p> <p>Tip: Use concise and descriptive names for the route list. The CompanynameLocationCalltype format usually provides a sufficient level of detail and is short enough to enable you to quickly and easily identify a route list. For example, 'CiscoDallasMetro' identifies a route list for toll-free, inter-local access transport area (LATA) calls from the Cisco office in Dallas.</p>
Description	A description of the route list.
Call Manager Group Name *	<p>Select a Unified CM Group. Default is the default field. You can choose from Default, None, or select a group. This field is mandatory.</p> <p>Note: The route list registers with the first Unified CM in the group (which is the Primary Unified CM).</p>
Route List Enabled	<p>Select to enable the route list. This is the default.</p> <p>Clear to disable the route list. When disabling a route list, calls in progress do not get affected, but the route list does not accept additional calls.</p>
Run on Every Node	Select to enable the active route list to run on every node.
Route Group Items	See "Route Group Items fields".

Route Group Items Fields

Field	Description
Route Group *	Choose the route group. This field is mandatory.
Selection Order	Indicate the order in which to prioritize multiple routes. A lower selection order indicates higher priority. This field requires an integer value. The default is no setting.
Use Calling Party's External Phone Number Mask *	Choose On from the drop-down list if you want the full external phone number to be used for calling line identification (CLID) on outgoing calls. Choose Off or Default if you do not want to use the full external phone number for CLID on outgoing calls. You may also configure an External Phone Number Mask on all phone devices. This field is mandatory.
Calling Party Transformation Mask	Enter a transformation mask value. Valid entries include the digits 0 through 9; the wildcard characters X, asterisk (*), and octothorpe (#); and the international escape character +. If the Digit Discards field is blank, the Prefix Digits field is blank, the Calling Party Transformation Mask field is blank, and Use Calling Party's External Phone Number Mask is set to Off or Default , no calling party transformation takes place.
Calling Party Prefix Digits	Enter prefix digits in the field. Valid entries include the digits 0 through 9, the wildcard characters asterisk (*) and octothorpe (#), and the international escape character +. Note: The appended prefix digit does not affect which directory numbers route to the assigned device.
Calling Party Number Type	Choose the format for the number type in calling party directory numbers. Unified CM sets the calling directory number (DN) type. Cisco recommends that you do not change the default value unless you have advanced experience with dialing plans such as NANP or the European dialing plan. You may need to change the default in Europe because Unified CM does not recognize European national dialing patterns. You can also change this setting when you are connecting to a PBX that expects the calling directory number to be encoded to a non national type numbering plan. Choose one of the following options: <ul style="list-style-type: none"> • Cisco CallManager - Use when the Unified CM sets the directory number type. • Unknown - Use when the dialing plan is unknown. • National - Use when you are dialing within the dialing plan for your country. • International - Use when you are dialing outside the dialing plan for your country. • Subscriber - Use when you are dialing a subscriber by using a shortened subscriber number.

Field	Description
Calling Party Numbering Plan	<p>Choose the format for the numbering plan in calling party directory numbers. Unified CM sets the calling DN numbering plan. Cisco recommends that you do not change the default value unless you have advanced experience with dialing plans such as NANP or the European dialing plan. You may need to change the default in Europe because Unified CM does not recognize European national dialing patterns. You can also change this setting when you are connecting to PBXs by using routing as a non-national type number.</p> <p>Choose one of the following options:</p> <ul style="list-style-type: none"> • Cisco CallManager - Use when the Unified CM sets the Numbering Plan in the directory number. • ISDN - Use when you are dialing outside the dialing plan for your country. • National Standard - Use when you are dialing within the dialing plan for your country. • Private - Use when you are dialing within a private network. • Unknown - Use when the dialing plan is unknown.
Called Party Discard Digits	Choose the discard digit instructions that you want to be associated with this called party transformation pattern.
Called Party Transform Mask	Enter a transformation mask value. Valid entries include the digits 0 through 9; the wildcard characters X, asterisk (*), and octothorpe (#); the international escape character +; and blank. If this field is blank and the preceding field is not checked, no transformation takes place.
Called Party Prefix Digits	Enter prefix digits in the field. Valid entries include the digits 0 through 9, the wildcard characters asterisk (*) and octothorpe (#), the international escape character +, and blank. Note: The appended prefix digit does not affect which directory numbers route to the assigned device.
Called Party Number Type	<p>Choose the format for the number type in called party directory numbers. Unified CM sets the called directory number (DN) type. Cisco recommends that you do not change the default value unless you have advanced experience with dialing plans such as NANP or the European dialing plan. You may need to change the default in Europe because Unified CM does not recognize European national dialing patterns. You can also change this setting when you are connecting to a PBX that expects the called directory number to be encoded to a non-national type numbering plan.</p> <p>Choose one of the following options:</p> <ul style="list-style-type: none"> • Cisco CallManager - Use when the Unified CM sets the directory number type. • Unknown - Use when the dialing plan is unknown. • National - Use when you are dialing within the dialing plan for your country. • International - Use when you are dialing outside the dialing plan for your country. • Subscriber - Use when you are dialing a subscriber by using a shortened subscriber number.

Field	Description
Called Party Numbering Plan	<p>Choose the format for the numbering plan in called party directory numbers. Unified CM sets the called DN numbering plan. Cisco recommends that you do not change the default value unless you have advanced experience with dialing plans such as NANP or the European dialing plan. You may need to change the default in Europe because Unified CM does not recognize European national dialing patterns. You can also change this setting when you are connecting to PBXs by using routing as a non-national type number.</p> <p>Choose one of the following options:</p> <ul style="list-style-type: none"> • Cisco CallManager - Use when the Unified CM sets the Numbering Plan in the directory number. • ISDN - Use when you are dialing outside the dialing plan for your country. • National Standard - Use when you are dialing within the dialing plan for your country. • Private - Use when you are dialing within a private network. • Unknown - Use when the dialing plan is unknown.

8.5. Route Patterns

8.5.1. How to Configure Cisco Unified Communications Manager Route Patterns

1. Log in as provider, reseller, or customer administrator.
2. Make sure the hierarchy path is set to the node where you want to add or edit the route pattern.
3. Perform one of:
 - If you are logged in as provider or reseller administrator, choose **Device Management > CUCM > Route Patterns**.
 - If you are logged in as customer administrator, choose: **Device Management > Advanced > Route Patterns**.
4. Perform one of:
 - To add a new route pattern, click **Add**, then go to Step 5.
 - To edit an existing route pattern, click on the pattern to be updated and go to Step 6.
5. From the **CUCM** drop-down menu, select the hostname, domain name, or IP address of the Unified CM to which you want to add the route pattern.

Note:

The **CUCM** drop-down menu only appears when a route pattern is added; it does not appear when you edit a route pattern.

Important:

If you are adding or editing a route pattern at any hierarchy node above a site level, the only Unified CMs that appear in the **CUCM** drop-down list are Unified CMs that are located at the node where you are adding the route pattern, and all Unified CMs in hierarchies above the node where you are adding the route pattern. If you are adding or editing a route pattern at a site level, the Unified CM that appears in the **CUCM** drop-down list is the Unified CM in the site's Network Device List (NDL). If the site does

not have an NDL, or the NDL at the site does not have a Unified CM, the drop-down list is empty and a route pattern can not be added to the site.

6. In the **Route Pattern** field, enter the route pattern, or modify the existing route pattern if desired. This field is mandatory. Enter the route pattern, including numbers and wildcards (do not use spaces); for example, enter 8XXX for a typical private network numbering plan. Valid characters include the uppercase characters A, B, C, and D and \+, which represents the international escape character +.
7. If you want to use a partition to restrict access to the route pattern, choose the desired partition from the **Route Partition** drop-down. If you do not want to restrict access to the route pattern, choose <None> for the partition.

Note:

Make sure that the combination of route pattern, route filter, and partition is unique within the Unified CM cluster.

8. In the **Description** field, enter a description for the route pattern and route partition if desired. The description can include up to 50 characters in any language, but it cannot include double-quotes ("), percentage sign (%), ampersand (&), or angle brackets (<>).
9. Complete at minimum, the mandatory fields on each tab as appropriate (see below):
10. Click **Save** when complete to save the new or updated route pattern.

Route Pattern: Pattern Definition Fields

Tip:

Use the Corresponding Cisco Unified Communications Manager (Unified CM) Attribute information provided in the table to manually verify in the Unified CM GUI that fields have been mapped correctly.

Option	Description
MLPP Precedence *	<p>From the drop-down menu, choose a Multilevel Precedence and Preemption (MLPP) service setting for this route pattern:</p> <ul style="list-style-type: none"> • Executive Override - Highest precedence setting for MLPP calls • Flash Override - Second highest precedence setting for MLPP calls • Flash - Third highest precedence setting for MLPP calls • Immediate - Fourth highest precedence setting for MLPP calls • Priority - Fifth highest precedence setting for MLPP calls • Routine - Lowest precedence setting for MLPP calls • Default - Does not override the incoming precedence level but rather lets it pass unchanged <p>Default: Default Corresponding Unified CM Attribute: MLPP Precedence.</p>
Apply Call Blocking Percentage	<p>Select this check box to enable the Destination Code Control (DCC) feature. By enabling DCC, all calls other than flash and higher precedence calls made to destination are filtered and allowed or disallowed based on the Call Blocking Percentage quota set for the destination. Flash and higher precedence calls are allowed at all times. DCC is disabled by default.</p> <p>Note: The Apply Call Blocking Percentage field gets enabled only if the MLPP level is immediate, priority, routine, or default. Default: Clear Corresponding Unified CM Attribute: Apply Call Blocking Percentage.</p>

Option	Description
Call Blocking Percentage	<p>Enter the percentage of calls to be blocked for this destination in numerals. This value specifies the percentage of lower precedence calls made to this destination that get blocked by the route pattern. This percentage limits the lower precedence calls only; the flash and higher precedence calls made to this destination are allowed at all times. Values between 0 and 99 are allowed.</p> <p>Note: Unified CM calculates the maximum number of low priority calls to be allowed through this route pattern based on the call blocking percentage that you set for this destination.</p> <p>Note: The Call Blocking Percentage field gets enabled only if the Apply Call Blocking Percentage check box is selected.</p> <p>Default: None Corresponding Unified CM Attribute: <Entry box next to Apply Call Blocking Percentage>.</p>
Route Class *	<p>From the drop-down menu, choose a route class setting for this route pattern:</p> <ul style="list-style-type: none"> • Default • Voice • Data • Satellite Avoidance • Hotline voice • Hotline data <p>The route class is a DSN code that identifies the class of traffic for a call. The route class informs downstream devices about special routing or termination requirements. The Default setting uses the existing route class of the incoming call.</p> <p>You can use non-default route class settings to translate an inbound T1 CAS route class digit into a Unified CM route class value (and strip off the digit). You should not need to assign a non-default route class setting to any other inbound calls that use pattern configuration.</p> <p>If the route pattern points to a SIP trunk supporting G.Clear, then specify Data or Hotline as the Route Class.</p> <p>Default: Default Corresponding Unified CM Attribute: Route Class.</p>
Route List (Mandatory if gateway or trunk is not specified)	<p>Choose the route list for which you are adding a route pattern. Default: None Corresponding Unified CM Attribute: Gateway/Route List.</p>
Gateway/Trunk (Mandatory if route list is not specified)	<p>Choose the gateway or trunk list for which you are adding a route pattern.</p> <p>Note: If the gateway is included in a Route Group, this drop-down menu does not display the gateway. When a gateway is chosen in the drop-down menu, Unified CM uses all the ports in the gateway to route or block this route pattern. This action does not apply for MGCP gateways.</p> <p>Default: Clear Corresponding Unified CM Attribute: Gateway/Route List.</p>

Option	Description
Block this pattern	Indicates whether you want this route pattern to be used for routing calls (such 8[2-9]XX) or for blocking calls. Default: Clear (meaning route pattern is used for routing calls). Corresponding Unified CM Attribute: Block this pattern.
Block Reason	If you click Block this pattern radio button above, you must choose the reason that you want this route pattern to block calls. From the drop-down menu, choose one of: <ul style="list-style-type: none"> • No Error • Unallocated Number • Call Rejected • Number Changed • Invalid Number Format • Precedence Level Exceeded Default: No Error Corresponding Unified CM Attribute: <entry box next to Block this pattern>.
Call Classification *	Call Classification indicates whether the call that is routed through this route pattern is considered either off (OffNet) or on (OnNet) the local network. When adding a route pattern, if you clear the Provide Outside Dial Tone check box, you set Call Classification as OnNet. Default: OnNet Corresponding Unified CM Attribute: Call Classification.
Allow Device Override	When the check box is selected, the system uses the Call Classification setting that is configured on the associated gateway or trunk to consider the outgoing call as OffNet or OnNet. Default: Clear Corresponding Unified CM Attribute: Allow Device Override
Provide Outside Dial Tone	Leave this check box selected to provide outside dial tone. To route the call in the network, clear the check box. Default: Clear Corresponding Unified CM Attribute: Provide Outside Dial Tone.
Allow Overlap Sending	With overlap sending enabled, when Unified CM passes a call to the PSTN, it relies on overlap sending in the PSTN to determine how many digits to collect and where to route the call. Select this check box for each route pattern that you consider to be assigned to a gateway or route list that routes the calls to a PSTN that supports overlap sending. The Client Matter Code (CMC) and Forced Authorization Code (FAC) features do not support overlap sending because the Unified CM cannot determine when to prompt the user for the code. If you select the Require Forced Authorization Code or the Require Client Matter Code check box, the system clears the Allow Overlap Sending check box. Default: Clear Corresponding Unified CM Attribute: Allow Overlap Sending
Urgent Priority	If the dial plan contains overlapping patterns, Unified CM does not route the call until the interdigit timer expires (even if it is possible to dial a sequence of digits to choose a current match). Select this check box to interrupt interdigit timing when Unified CM must route a call immediately. Default: Clear Corresponding Unified CM Attribute: Urgent Priority.

Option	Description
Require Forced Authorization Code	<p>If you want to use forced authorization codes with this route pattern, select the check box.</p> <p>The FAC feature does not support overlap sending because the Unified CM cannot determine when to prompt the user for the code. If you select the Allow Overlap Sending check box, you should clear the Require Forced Authorization Code check box.</p> <p>Default: Clear</p> <p>Corresponding Unified CM Attribute: Require Forced Authorization Code.</p>
Authorization Level *	<p>Enter the authorization level for the route pattern. The number that you specify in this field determines the minimum authorization level that is needed to successfully route a call through this route pattern. Range is 0 to 255.</p> <p>Default: 0</p> <p>Corresponding Unified CM Attribute: Authorization Level</p>
Require Client Matter Code	<p>If you want to use client matter codes with this route pattern, select this check box.</p> <p>The CMC feature does not support overlap sending because the Unified CM cannot determine when to prompt the user for the code. If you select the Allow Overlap Sending check box, you should clear the Require Client Matter Code check box.</p> <p>Default: Clear</p> <p>Corresponding Unified CM Attribute: <Entry box next to Authorization Level>.</p>

Route Pattern: Calling Party Transformations Fields

Option	Description
Use Calling Party's External Phone Number Mask	<p>Select the check box if you want the full, external phone number to be used for calling line identification (CLID) on outgoing calls.</p> <p>Note: The calling party transformation settings that are assigned to the route groups in a route list override any calling party transformation settings that are assigned to a route pattern that is associated with that route list.</p> <p>Default: Default Corresponding Unified CM Attribute: Use Calling Party's External Phone Number Mask</p>
Calling Party Transform Mask	<p>Enter a transformation mask value. Valid entries for the National Numbering Plan include the digits 0 through 9, and the wildcard characters asterisk (*) and octothorpe (#); the international escape character +; and blank. If this field is blank and the preceding field is clear, no calling party transformation takes place.</p> <p>Default: None Corresponding Unified CM Attribute: Calling Party Transform Mask</p>
Prefix Digits (Outgoing Calls)	<p>Enter prefix digits. Valid entries for the National Numbering Plan include the digits 0 through 9, and the wildcard characters asterisk (*) and octothorpe (#); the international escape character +.</p> <p>Note: The appended prefix digit does not affect which directory numbers route to the assigned device.</p> <p>Default: None Corresponding Unified CM Attribute: Prefix Digits (Outgoing Calls).</p>

Option	Description
Calling Line ID Presentation *	<p>Unified CM uses calling line ID presentation/restriction (CLIP/CLIR) as a supplementary service to allow or restrict the originating caller phone number on a call-by-call basis.</p> <p>Choose whether you want the Unified CM to allow or restrict the display of the calling party phone number on the called party phone display for this route pattern.</p> <p>Choose one of:</p> <ul style="list-style-type: none"> • Default - Choose if you do not want to change calling line ID presentation. • Allowed - Choose if you want Unified CM to allow the display of the calling number. • Restricted - Choose if you want Unified CM to block the display of the calling number. <p>For more information about this field, see topics related to calling party number transformations settings in the Cisco Unified Communications Manager System Guide.</p> <p>Default: Default</p> <p>Corresponding Unified CM Attribute: Calling Line ID Presentation.</p>
Calling Name Presentation *	<p>Unified CM uses calling name presentation (CNIP/CNIR) as a supplementary service to allow or restrict the originating caller name on a call-by-call basis.</p> <p>Choose whether you want the Unified CM to allow or restrict the display of the calling party name on the called party phone display for this route pattern.</p> <p>Choose one of:</p> <ul style="list-style-type: none"> • Default - Choose if you do not want to change calling name presentation. • Allowed - Choose if you want Unified CM to allow the display of the calling name information. • Restricted - Choose if you want Unified CM to block the display of the calling name information. <p>For more information about this field, see calling party number transformations settings in the Cisco Unified Communications Manager System Guide.</p> <p>Default: Default</p> <p>Corresponding Unified CM Attribute: Calling Name Presentation.</p>
Calling Party Number Type *	<p>Choose the format for the number type in calling party directory numbers.</p> <p>Unified CM sets the calling directory number (DN) type. Cisco recommends that you do not change the default value unless you have advanced experience with dialing plans such as NANP or the European dialing plan. You may need to change the default in Europe because Unified CM does not recognize European national dialing patterns. You can also change this setting when you are connecting to a PBX that expects the calling directory number to be encoded to a non-national numbering plan type.</p> <p>Choose one of:</p> <ul style="list-style-type: none"> • Unified CM - the Unified CM sets the directory number type. • Unknown - The dialing plan is unknown. • National - Use when you are dialing within the dialing plan for your country. • International - Use when you are dialing outside the dialing plan for your country. • Subscriber - Use when you are dialing a subscriber by using the shortened subscriber name. <p>Default: Unified CM</p> <p>Corresponding Unified CM Attribute: Calling Party Number Type.</p>

Option	Description
Calling Party Numbering Plan *	<p>Choose the format for the numbering plan in calling party directory numbers. Unified CM sets the calling DN numbering plan. Cisco recommends that you do not change the default value unless you have advanced experience with dialing plans such as NANP or the European dialing plan. You may need to change the default in Europe because Unified CM does not recognize European national dialing patterns. You can also change this setting when you are connecting to PBXs by using routing as a non-national type number.</p> <p>Choose one of:</p> <ul style="list-style-type: none"> • Unified CM - Use when the Unified CM sets the Numbering Plan in the directory number. • ISDN - Use when you are dialing outside the dialing plan for your country. • National Standard - Use when you are dialing within the dialing plan for your country. • Private - Use when you are dialing within a private network. • Unknown - Use when the dialing plan is unknown. <p>Default: Unified CM Corresponding Unified CM Attribute: Calling Party Numbering Plan.</p>

Route Pattern: Connected Party Transformations Fields

Option	Description
Connected Line ID Presentation *	<p>Unified CM uses connected line ID presentation (COLP/COLR) as a supplementary service to allow or restrict the called party phone number on a call-by-call basis.</p> <p>Choose whether you want Unified CM to allow or restrict the display of the connected party phone number on the calling party phone display for this route pattern.</p> <p>Choose one of:</p> <ul style="list-style-type: none"> • Default - Choose if you do not want to change the connected line ID presentation. • Allowed - Choose if you want to display the connected party phone number. • Restricted - Choose if you want Unified CM to block the display of the connected party phone number. <p>If a call that originates from an IP phone on Unified CM encounters a device, such as a trunk, gateway, or route pattern, that has the Connected Line ID Presentation set to Default, the presentation value is automatically set to Allowed.</p> <p>For more information about this field, see topics related to connected party presentation and restriction settings in the Cisco Unified Communications Manager System Guide.</p> <p>Default: Default Corresponding Unified CM Attribute: Connected Line ID Presentation.</p>

Option	Description
Connected Name Presentation *	<p>Unified CM uses connected name presentation (CONP/CONR) as a supplementary service to allow or restrict the called party name on a call-by-call basis.</p> <p>Choose whether you want Unified CM to allow or restrict the display of the connected party name on the calling party phone display for this route pattern. Choose one of:</p> <ul style="list-style-type: none"> • Default - Choose if you do not want to change the connected name presentation. • Allowed - Choose if you want to display the connected party name. • Restricted - Choose if you want Unified CM to block the display of the connected party name. <p>For more information about this field, see topics related to connected party presentation and restriction settings in the Cisco Unified Communications Manager System Guide.</p> <p>Default: Default Corresponding Unified CM Attribute: Connected Name Presentation.</p>

Route Pattern: Called Party Transformations Fields

Option	Description
Discard Digits	<p>Choose the discard digits instructions that you want to be associated with this route pattern. See topics related to discard digits instructions in the Cisco Unified Communications Manager System Guide for more information.</p> <p>Default: None Corresponding Unified CM Attribute: Discard Digits.</p>
Called Party Transform Mask	<p>Enter a transformation mask value. Valid entries for the National Numbering Plan include the digits 0 through 9, and the wildcard characters asterisk (*) and octothorpe (#); the international escape character +; and blank. If the field is blank, no transformation takes place. The dialed digits get sent exactly as dialed.</p> <p>Default: None Corresponding Unified CM Attribute: Called Party Transform Mask.</p>
Prefix Digits (Outgoing Calls)	<p>Enter prefix digits. Valid entries for the National Numbering Plan include the digits 0 through 9, and the wildcard characters asterisk (*) and octothorpe (#); the international escape character +; and blank.</p> <p>Note: The appended prefix digit does not affect which directory numbers route to the assigned device.</p> <p>Default: None Corresponding Unified CM Attribute: Prefix Digits (Outgoing Calls).</p>

Option	Description
Called Party Number Type *	<p>Choose the format for the number type in called party directory numbers. Unified CM sets the called directory number (DN) type. Cisco recommends that you do not change the default value unless you have advanced experience with dialing plans such as NANP or the European dialing plan. You may need to change the default in Europe because Unified CM does not recognize European national dialing patterns. You can also change this setting when you are connecting to a PBX that expects the called directory number to be encoded to a non-national type numbering plan.</p> <p>Choose one of:</p> <ul style="list-style-type: none"> • Unified CM - Use when the Unified CM sets the directory number type. • Unknown - Use when the dialing plan is unknown. • National - Use when you are dialing within the dialing plan for your country. • International - Use when you are dialing outside the dialing plan for your country. • Subscriber - Use when you are dialing a subscriber by using a shortened subscriber number. <p>Default: Unified CM Corresponding Unified CM Attribute: Called Party Number Type.</p>
Called Party Numbering Plan *	<p>Choose the format for the numbering plan in called party directory numbers. Unified CM sets the called DN numbering plan. Cisco recommends that you do not change the default value unless you have advanced experience with dialing plans such as NANP or the European dialing plan. You may need to change the default in Europe because Unified CM does not recognize European national dialing patterns. You can also change this setting when you are connecting to PBXs by using routing as a non-national type number.</p> <p>Choose one of:</p> <ul style="list-style-type: none"> • Unified CM - Use when the Unified CM sets the Numbering Plan in the directory number. • ISDN - Use when you are dialing outside the dialing plan for your country. • National Standard - Use when you are dialing within the dialing plan for your country. • Private - Use when you are dialing within a private network. • Unknown - Use when the dialing plan is unknown. <p>Default: Unified CM Corresponding Unified CM Attribute: Called Party Numbering Plan.</p>

8.6. Translation Patterns

8.6.1. How to Configure Cisco Unified Communications Manager Translation Patterns

1. Log in as provider, reseller, or customer administrator.
2. Set the hierarchy path to the node where you want to add or edit the translation pattern.
3. Perform one of:
 - If you are signed in as provider or reseller administrator, choose **Device Management > CUCM > Translation Patterns**.

- If you are signed in as customer administrator, choose **Device Management > Advanced > Translation Patterns**.

4. Perform one of:

- To add a new translation pattern, click **Add**, then go to Step 5.
- To edit an existing translation pattern, click on the pattern to be updated and go to Step 6.

5. From the **CUCM** drop-down menu, choose the hostname, domain name, or IP address of the Cisco Unified Communications Manager to which you want to add the translation pattern.

Note:

The **CUCM** drop-down menu only appears when a translation pattern is added; it does not appear when you edit a translation pattern.

Important:

If you are adding or editing a translation pattern at any hierarchy node above a site level, the only Unified CMs that appear in the **CUCM** drop-down list are Unified CMs that are located at the node where you are adding the translation pattern, and all Unified CMs in hierarchies above the node where you are adding the translation pattern. If you are adding or editing a translation pattern at a site level, the Unified CM that appears in the **CUCM** drop-down list is the Unified CM in the site's Network Device List (NDL). If the site does not have an NDL, or the NDL at the site does not have a Unified CM, then the drop-down list is empty and a translation pattern cannot be added to the site.

6. In the **Translation Pattern** field, enter a unique name for the translation pattern, or modify the existing name of the translation pattern if desired. You can include numbers and wildcards (do not use spaces), in the **Translation Pattern** field. For example, enter 8XXX for a typical private network numbering plan. Valid characters include the uppercase characters A, B, C, and D and \+, which represents the international escape character +. This field is mandatory.
7. In the **Partition** field, enter a unique name for the route partition, or modify the existing name of the partition if desired. This field is mandatory.
8. In the **Description** field, enter a description for the translation pattern and route partition if desired. The description can include up to 50 characters in any language, but it cannot include double-quotes ("), percentage sign (%), ampersand (&), or angle brackets (<>).
9. Complete at minimum, the mandatory fields on each tab as appropriate (see below):

Tip: Use the Corresponding Cisco Unified Communications Manager (Unified CM) attribute information provided in the tables to manually verify in the Unified CM GUI that fields have been mapped correctly.

10. Click **Save** when complete to save the new or updated translation pattern.

Translation Patterns: Pattern Definition Fields

Option	Description
MLPP Precedence *	<p>From the drop-down menu, choose a Multilevel Precedence and Preemption (MLPP) service setting for this translation pattern:</p> <ul style="list-style-type: none"> • Executive Override - Highest precedence setting for MLPP calls. • Flash Override - Second highest precedence setting for MLPP calls. • Flash - Third highest precedence setting for MLPP calls. • Immediate - Fourth highest precedence setting for MLPP calls. • Priority - Fifth highest precedence setting for MLPP calls. • Routine - Lowest precedence setting for MLPP calls. • Default - Does not override the incoming precedence level but rather lets it pass unchanged. <p>Default: Default Corresponding Unified CM Attribute: MLPP Precedence.</p>
Route Class *	<p>From the drop-down menu, choose a route class setting for this translation pattern:</p> <ul style="list-style-type: none"> • Default • Voice • Data • Satellite Avoidance • Hotline voice • Hotline data <p>The route class is a DSN code that identifies the class of traffic for a call. The route class informs downstream devices about special routing or termination requirements. The Default setting uses the existing route class of the incoming call. You can use non-default route class settings to translate an inbound T1 CAS route class digit into a Unified CM Cisco Unified Communications Manager route class value (and strip off the digit). You should not need to assign a non-default route class setting to any other inbound calls that use pattern configuration. If the route pattern points to a SIP trunk supporting G.Clear, then specify Data or Hotline as the Route Class.</p> <p>Default: Default Corresponding Unified CM Attribute: Route Class.</p>
Calling Search Space	<p>From the drop-down menu, choose the calling search space for which you are adding a translation pattern, if necessary.</p> <p>Default: None Corresponding Unified CM Attribute: Calling Search Space.</p>

Option	Description
Use Originator's Calling Search Space	<p>To use the originator's calling search space for routing a call, select the Use Originator's Calling Search Space check box.</p> <p>If the originating device is a phone, the originator's calling search space is a result of device calling search space and line calling search space.</p> <p>Whenever a translation pattern chain is encountered, for subsequent lookups Calling Search Space is selected depending upon the value of this check box at current translation pattern. If you select the Use Originator's Calling Search Space check box at current translation pattern, then originator's Calling Search Space is used and not the Calling Search Space for the previous lookup. If you clear the Use Originator's Calling Search Space check box at current translation pattern, then Calling Search Space configured at current translation pattern is used.</p> <p>Default: Clear</p> <p>Corresponding Unified CM Attribute: Use Originator's Calling Search Space.</p>
Block this pattern	<p>Indicates whether you want this translation pattern to be used for routing calls (such 8[2-9]XX) or for blocking calls.</p> <p>Default: Clear (meaning translation pattern is used for routing calls).</p> <p>Corresponding Unified CM Attribute: Block this pattern.</p>
Block Reason	<p>If you click Block this pattern radio button above, you must choose the reason that you want this translation pattern to block calls. From the drop-down menu, choose one of:</p> <ul style="list-style-type: none"> • No Error • Unallocated Number • Call Rejected • Number Changed • Invalid Number Format • Precedence Level Exceeded <p>Default: No Error</p> <p>Corresponding Unified CM Attribute: <entry box next to Block this pattern>.</p>
Provide Outside Dial Tone	<p>Outside dial tone indicates that Unified CM routes the calls off the local network. Select this check box for each translation pattern that you consider to be off network.</p> <p>Default: Selected</p> <p>Corresponding Unified CM Attribute: Provide Outside Dial Tone.</p>
Urgent Priority	<p>If the dial plan contains overlapping patterns, Unified CM does not route the call until the interdigit timer expires (even if it is possible to dial a sequence of digits to choose a current match). Select this check box to interrupt interdigit timing when Unified CM must route a call immediately.</p> <p>Default: Clear</p> <p>Corresponding Unified CM Attribute: Urgent Priority.</p>

Option	Description
Do Not Wait for Interdigit Timeout on Subsequent Hops	<p>When you select this check box along with the Urgent Priority check box and the translation pattern matches with a sequence of dialed digits (or whenever the translation pattern is the only matching pattern), Unified CM does not start the interdigit timer after it matches any of the subsequent patterns.</p> <p>Note: Unified CM does not start the interdigit timer even if subsequent patterns are of variable length or if overlapping patterns exist for subsequent matches. Whenever you select the Do Not Wait For Interdigit Timeout On Subsequent Hops check box that is associated with a translation pattern in a translation pattern chain, Unified CM does not start the interdigit timer after it matches any of the subsequent patterns.</p> <p>Note: Unified CM does not start interdigit timer even if subsequent translation patterns in a chain have Do Not Wait For Interdigit Timeout On Subsequent Hops check box cleared.</p> <p>Default: Clear Corresponding Unified CM Attribute: Do Not Wait for Interdigit Timeout On Subsequent Hops.</p>
Route Next Hop By Calling Party Number	<p>Select this check box to enable routing based on the calling party number, which is required for call screening based on caller ID information to work between clusters.</p> <p>Default: Clear Corresponding Unified CM Attribute: Route Next Hop By Calling Party Number.</p>

Translation Patterns: Calling Party Transformations Fields

Option	Description
Use Calling Party's External Phone Number Mask	<p>Select the check box if you want the full, external phone number to be used for calling line identification (CLID) on outgoing calls.</p> <p>Default: Default Corresponding Unified CM Attribute: Use Calling Party's External Phone Number Mask.</p>
Calling Party Transform Mask	<p>Enter a transformation mask value. Valid entries for the National Numbering Plan include the digits 0 through 9, and the wildcard characters asterisk (*) and octothorpe (#); the international escape character +; and blank. If this field is blank and the preceding field is cleared, no calling party transformation takes place.</p> <p>Default: None Corresponding Unified CM Attribute: Calling Party Transform Mask.</p>
Prefix Digits (Outgoing Calls)	<p>Enter prefix digits. Valid entries for the National Numbering Plan include the digits 0 through 9, and the wildcard characters asterisk (*) and octothorpe (#); the international escape character +.</p> <p>Note: The appended prefix digit does not affect which directory numbers route to the assigned device.</p> <p>Default: None Corresponding Unified CM Attribute: Prefix Digits (Outgoing Calls).</p>

Option	Description
Calling Line ID Presentation *	<p>Unified CM uses calling line ID presentation/restriction (CLIP/CLIR) as a supplementary service to allow or restrict the originating caller phone number on a call-by-call basis.</p> <p>Choose whether you want the Unified CM to allow or restrict the display of the calling party phone number on the called party phone display for this translation pattern.</p> <p>Choose one of:</p> <ul style="list-style-type: none"> • Default - Choose if you do not want to change calling line ID presentation. • Allowed - Choose if you want Unified CM to allow the display of the calling number. • Restricted - Choose if you want Unified CM to block the display of the calling number. <p>For more information about this field, see topics related to calling party number transformations settings in the Cisco Unified Communications Manager System Guide.</p> <p>Note:</p> <p>Use this parameter and the Connected Line ID Presentation parameter, in combination with the Ignore Presentation Indicators (internal calls only) device-level parameter, to configure call display restrictions. Together, these settings allow you to selectively present or restrict calling and/or connected line display information for each call. See topics related to device profile configuration settings and phone settings for information about the Ignore Presentation Indicators (internal calls only) field, and for more information about call display restrictions, see topics related to call display restrictions in the Cisco Unified Communications Manager System Guide.</p> <p>Default: Default</p> <p>Corresponding Unified CM Attribute: Calling Line ID Presentation.</p>

Option	Description
Calling Name Presentation *	<p>Unified CM uses calling name presentation (CNIP/CNIR) as a supplementary service to allow or restrict the originating caller name on a call-by-call basis. Choose whether you want the Unified CM to allow or restrict the display of the calling party name on the called party phone display for this translation pattern.</p> <p>Choose one of:</p> <ul style="list-style-type: none"> • Default - Choose if you do not want to change calling name presentation. • Allowed - Choose if you want Unified CM to allow the display of the calling name information. • Restricted - Choose if you want Unified CM to block the display of the calling name information. <p>For more information about this field, see calling party number transformations settings in the Cisco Unified Communications Manager System Guide.</p> <p>Default: Default Corresponding Unified CM Attribute: Calling Name Presentation.</p>
Calling Party Number Type *	<p>Choose the format for the number type in calling party directory numbers. Unified CM sets the calling directory number (DN) type. Cisco recommends that you do not change the default value unless you have advanced experience with dialing plans such as NANP or the European dialing plan. You may need to change the default in Europe because Unified CM does not recognize European national dialing patterns. You can also change this setting when you are connecting to a PBX that expects the calling directory number to be encoded to a non-national numbering plan type.</p> <p>Choose one of:</p> <ul style="list-style-type: none"> • Unified CM - the Unified CM sets the directory number type. • Unknown - The dialing plan is unknown. • National - Use when you are dialing within the dialing plan for your country. • International - Use when you are dialing outside the dialing plan for your country. • Subscriber - Use when you are dialing a subscriber by using the shortened subscriber name. <p>Default: Unified CM Corresponding Unified CM Attribute: Calling Party Number Type.</p>

Option	Description
Calling Party Numbering Plan *	<p>Choose the format for the numbering plan in calling party directory numbers. Unified CM sets the calling DN numbering plan. Cisco recommends that you do not change the default value unless you have advanced experience with dialing plans such as NANP or the European dialing plan. You may need to change the default in Europe because Unified CM does not recognize European national dialing patterns. You can also change this setting when you are connecting to PBXs by using routing as a non-national type number.</p> <p>Choose one of:</p> <ul style="list-style-type: none"> • Unified CM - Use when the Unified CM sets the Numbering Plan in the directory number. • ISDN - Use when you are dialing outside the dialing plan for your country. • National Standard - Use when you are dialing within the dialing plan for your country. • Private - Use when you are dialing within a private network. • Unknown - Use when the dialing plan is unknown. <p>Default: Unified CM Corresponding Unified CM Attribute: Calling Party Numbering Plan.</p>

Translation Patterns: Connected Party Transformations Fields

Option	Description
Connected Line ID Presentation *	<p>Unified CM uses connected line ID presentation (COLP/COLR) as a supplementary service to allow or restrict the called party phone number on a call-by-call basis. Choose whether you want Unified CM to allow or restrict the display of the connected party phone number on the calling party phone display for this translation pattern. Choose one of:</p> <ul style="list-style-type: none"> • Default - Choose if you do not want to change the connected line ID presentation. • Allowed - Choose if you want to display the connected party phone number. • Restricted - Choose if you want Unified CM to block the display of the connected party phone number. <p>If a call that originates from an IP phone on Unified CM encounters a device, such as a trunk, gateway, or route pattern, that has the Connected Line ID Presentation set to Default, the presentation value is automatically set to Allowed.</p> <p>For more information about this field, see topics related to connected party presentation and restriction settings in the Cisco Unified Communications Manager System Guide.</p> <p>Default: Default Corresponding Unified CM Attribute: Connected Line ID Presentation.</p>
Connected Name Presentation *	<p>(CONP/CONR) as a supplementary service to allow or restrict the called party name on a call-by-call basis. Choose whether you want Unified CM to allow or restrict the display of the connected party name on the calling party phone display for this translation pattern. Choose one of:</p> <ul style="list-style-type: none"> • Default - Choose if you do not want to change the connected name presentation. • Allowed - Choose if you want to display the connected party name. • Restricted - Choose if you want Unified CM to block the display of the connected party name. <p>For more information about this field, see topics related to connected party presentation and restriction settings in the Cisco Unified Communications Manager System Guide.</p> <p>Default: Default Corresponding Unified CM Attribute: Connected Name Presentation.</p>

Translation Patterns: Called Party Transformations Fields

Option	Description
Discard Digits	<p>Choose the discard digits instructions that you want to be associated with this translation pattern. See topics related to discard digits instructions in the Cisco Unified Communications Manager System Guide for more information.</p> <p>Default: None</p> <p>Corresponding Unified CM Attribute: Discard Digits.</p>
Called Party Transform Mask	<p>Enter a transformation mask value. Valid entries for the National Numbering Plan include the digits 0 through 9, and the wildcard characters asterisk (*) and octothorpe (#); the international escape character +; and blank. If the field is blank, no transformation takes place. The dialed digits get sent exactly as dialed.</p> <p>Default: None</p> <p>Corresponding Unified CM Attribute: Called Party Transform Mask.</p>
Prefix Digits (Outgoing Calls)	<p>Enter prefix digits. Valid entries for the National Numbering Plan include the digits 0 through 9, and the wildcard characters asterisk (*) and octothorpe (#); the international escape character +; and blank.</p> <p>Note:</p> <p>The appended prefix digit does not affect which directory numbers route to the assigned device.</p> <p>Default: None</p> <p>Corresponding Unified CM Attribute: Prefix Digits (Outgoing Calls).</p>
Called Party Number Type *	<p>Choose the format for the number type in called party directory numbers. Unified CM sets the called directory number (DN) type. Cisco recommends that you do not change the default value unless you have advanced experience with dialing plans such as NANP or the European dialing plan. You may need to change the default in Europe because Unified CM does not recognize European national dialing patterns. You can also change this setting when you are connecting to a PBX that expects the called directory number to be encoded to a non-national type numbering plan.</p> <p>Choose one of:</p> <ul style="list-style-type: none"> • Unified CM - Use when the Unified CM sets the directory number type. • Unknown - Use when the dialing plan is unknown. • National - Use when you are dialing within the dialing plan for your country. • International - Use when you are dialing outside the dialing plan for your country. • Subscriber - Use when you are dialing a subscriber by using a shortened subscriber number. <p>Default: Unified CM</p> <p>Corresponding Unified CM Attribute: Called Party Number Type.</p>

Option	Description
Called Party Numbering Plan *	<p>Choose the format for the numbering plan in called party directory numbers. Unified CM sets the called DN numbering plan. Cisco recommends that you do not change the default value unless you have advanced experience with dialing plans such as NANP or the European dialing plan. You may need to change the default in Europe because Unified CM does not recognize European national dialing patterns. You can also change this setting when you are connecting to PBXs by using routing as a non-national type number.</p> <p>Choose one of:</p> <ul style="list-style-type: none"> • Unified CM - Use when the Unified CM sets the Numbering Plan in the directory number. • ISDN - Use when you are dialing outside the dialing plan for your country. • National Standard - Use when you are dialing within the dialing plan for your country. • Private - Use when you are dialing within a private network. • Unknown - Use when the dialing plan is unknown. <p>Default: Unified CM Corresponding Unified CM Attribute: Called Party Numbering Plan.</p>

8.7. CUCM Music On Hold (MOH)

8.7.1. Music on Hold (MOH) File Management

The VOSS-4-UC MOH File Management feature allows administrators to carry out a number of tasks within the Admin Portal to manage MOH servers and files, including the upload of MOH files to Unified CM.

MOH file management in VOSS-4-UC consists of a number of steps:

- Manage CUCM MOH Clusters.
- Upload MOH `.wav` files to VOSS-4-UC.
- Upload MOH `.wav` files to CUCM MOH clusters.
- Add and manage MOH Audio Sources for use in VOSS-4-UC (for example line and hunt group management).

Note: If a `.wav` file is deleted from VOSS-4-UC, it is not removed from CUCM MOH clusters.

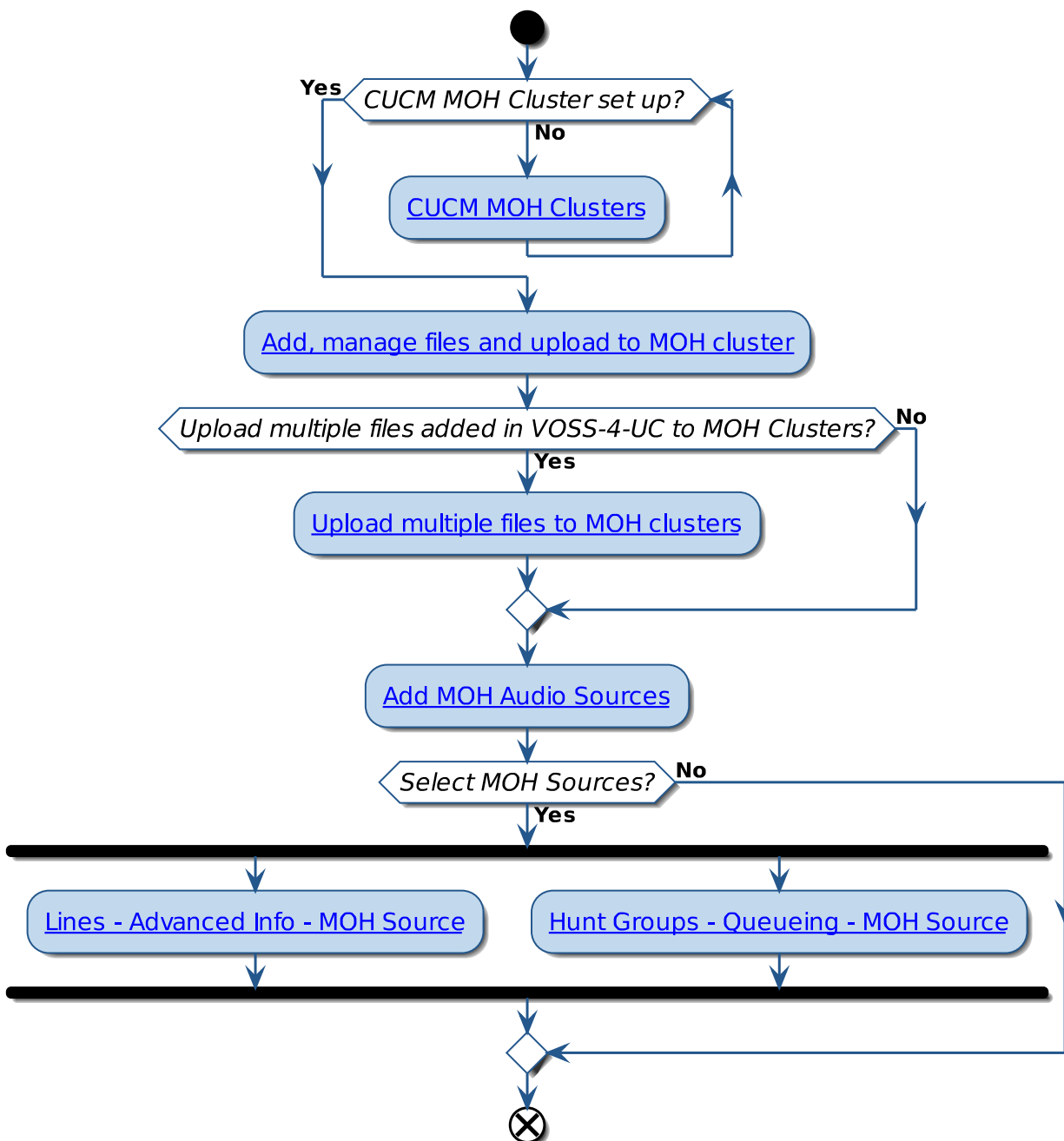

CUCM MOH Clusters

Unified CM clusters can be managed from the **Manage MOH Clusters** menu.

1. Click **Add** to start the task.

2. MOH Cluster details:

- **Cluster Name:** add a name for the CUCM MOH cluster, this can be the same as the Unified CM Cluster name or a unique name.
- **Publisher Server Name:** the drop-down shows a list of Unified CM publisher servers added at

the hierarchy, select the required one.

- **Publisher Hostname or IP Address:** populated based on the Server Name chosen, this must match the SERVICE_PROVIDER_SPACE hostname or IPv4 address of the CUCM publisher server.

Note: By default, the port used to connect to the publisher is 443.

- **Publisher Username:** username of a user which has administrative access to the Unified CM server GUI.
- **Publisher Password:** password of the user.
- **Subscriber Details:** add the details of the subscriber servers which are part of the Unified CM cluster.
 - Enable **Is Music Server** if the subscriber performs the role of Music on Hold. MOH Files are only uploaded to the subscriber servers which have **Is Music Server** enabled.

Note: By default, the port used to connect to the subscriber is 443.

3. Click **Save** to carry out the task.

Add, Manage Files and Upload to MOH Cluster

This functionality allows an administrator to add MOH files to VOSS-4-UC by uploading them. Optionally, the MOH file can also be uploaded to an applicable CUCM at the same time as adding it to VOSS-4-UC or after the file is already in VOSS-4-UC.

From the **Manage Files and Upload to MOH Cluster** menu, MOH `.wav` files can be:

- Uploaded to VOSS-4-UC.
- Uploaded to a CUCM MOH Cluster: files are uploaded to the publisher server, as well as the subscriber servers which have the **Is Music Server** check box enabled.

1. Click **Add** to start the task.
2. Click **Browse** to select the `.wav` file from your file system to show in the **Filename** input box and to upload it.

An optional **Description** can be added to the uploaded filename.

Select the **CUCM MOH Cluster**. If a **CUCM MOH Cluster** is *not* selected, then the file is only uploaded to VOSS-4-UC.

Note:

- When uploading files at site level the CUCM MOH Cluster is automatically selected based on the site Network Device List (NDL).
 - Uploading files to the pre-release version of CUCM 12.5.1 SU1(12.5.1.11900-20) will fail.
-

3. Click **Save** to complete the task.

Notes on management tasks:

- If a file with same name as an existing file is uploaded at the same hierarchy, then the existing file will be deleted automatically.
- A `.wav` file that has been uploaded to VOSS-4-UC previously can be re-uploaded to the same CUCM MOH Cluster again or another CUCM MOH cluster.
- If a `.wav` file is deleted from VOSS-4-UC, it is not removed from CUCM MOH clusters.

Upload Multiple Files to MOH Clusters (Optional)

Two side-by-side transfer boxes are available from the **Upload Multiple Files to MOH Clusters** menu to add uploaded files in VOSS-4-UC to MOH Clusters.

To carry out multiple uploads, select CUCM MOH clusters and MOH file names from the **Available** transfer boxes.

Click **Save** to complete the task.

MOH Audio Sources

In order to make use of the MOH files that have been uploaded to CUCM MOH clusters, a MOH Audio Source instance needs to be created:

To add a MOH Audio Source:

Choose the **Add MOH Audio Source** menu:

- **CUCM MOH Cluster:** the CUCM MOH Cluster where the Audio Source will be added to.
- **MOH Audio Source Name:** a descriptive, *unique* name for the MOH Audio Source.
- **MOH Audio Stream Number:** select an available audio stream number.
- **MOH Audio Stream File:** select a MOH File which has been uploaded to the chosen MOH CUCM Cluster.

Note that:

- stream numbers in use will not show
- 051 is reserved for a fixed MOH audio source and is not shown

- **MOH Audio Source File:** the file previously uploaded to the CUCM MOH cluster.

To manage MOH Audio Sources:

Additional details for a selected Audio Source can be managed. Choose the **Manage MOH Audio Source** menu:

- **MOH Audio Stream Number:** read-only
- **MOH Audio Source Name:** read-only
- **MOH Audio Source File:** read-only

Announcement Settings are available for management:

- **Initial Announcement:** choose an available Announcement from drop-down
- **Play Initial Announcement to Hunt Pilot callers:** check-box enabled by default. Clear to disable when an agent is available.
- **Periodic Announcement:** choose an available Announcement from drop-down
- **Periodic Announcement interval:** Enter a value in seconds (10s-300s). Default is 30s.

- **Locale Announcement:** choose an available Locale from drop-down

The added MOH Audio Sources are available to:

- Manage for **Lines** as MOH Audio Source as a part of **Subscriber Management** - see Directory Number Advanced Information, MOH Source at [Configure Lines](#).
- Manage for **Hunt Groups** as **Queuing** MOH Audio Source as a part of **Subscriber Management** - see [Add a Hunt Group](#).

8.8. CUCM FAC Management

8.8.1. Forced Authorization Codes (FAC)

This Unified CM feature provides the ability to use codes to authorize certain types of calls as setup in the dial plan. For example, to make an international call, a code might be shared with people who need it and they can enter the code after dialing their call in order to authorize this.

To use FAC codes, the deployed dial plan must to be setup in a way that enables the codes to be used. For more details on the use of FAC codes and Unified CM functionality refer to the Cisco UCM feature guides.

VOSS-4-UC provides full support for FAC codes from setting up the dial plan elements to the management of the codes themselves. Refer to the *VOSS-4-UC Provider HCS Dial Plan Management Support Guide* for more details on managing the dial plan elements.

VOSS-4-UC supports the provisioning of FAC codes using two methods:

- *Forced Authorization Code (FAC) Management using Device Models* - this basically mirrors the setting up of codes in the Unified CM. It uses the device model in VOSS-4-UC and allows you to add/mod/del codes for a given cluster.
- *Forced Authorization Code (FAC) Management using VOSS-4-UC* - this feature helps to improve the usability of FAC codes and to manage consistent FAC codes across clusters in an orchestrated way. It provides the ability to define which authorization levels you require and to provide text along with the code to help administrators understand the purpose of the different levels as implemented in the dial plan.

The method to use depends on your requirements, but generally the VOSS-4-UC FAC Code Management method is likely to be a better overall fit.

The appropriate option(s) you want to use should be included in your menu designs for the required roles for administrators to access. You may want to use both methods if you need to manage FAC codes per cluster in some cases, and across clusters for other cases. Any existing codes synced into VOSS-4-UC will appear in VOSS-4-UC and can be managed via either method.

8.8.2. Forced Authorization Code (FAC) Management using Device Models

This method is typically used if you want to manage FAC codes within the context of a given cluster (or only have single cluster deployments). You can add/mod/del FAC codes in the system including via the bulk capabilities of VOSS-4-UC. If there won't be large number of FAC codes implemented and/or this remains an advanced administration task, this might be the best approach.

To manage FAC codes using this method, select the FAC Codes menu (exposed via the `device/cucm/FacInfo` device model):

To add a FAC code

1. Browse to the appropriate hierarchy level for the FAC code (e.g. Customer or Site).
2. Navigate to the FAC Code menu item which will give a list of existing codes.
3. Click **Add**. If there is more than one Unified CM cluster at that hierarchy, then you will get a pop-up to choose the appropriate cluster.
4. Enter the details of the FAC code to be added in the form and click **Save**.

To modify an existing code

1. Navigate to the FAC Code menu item which will give a list of existing codes. Use the filters and/or hierarchy breadcrumb to locate the code to modify and then select it.
2. Edit the settings and click **Save**.

To delete an existing code

1. Navigate to the FAC Code menu item which will give a list of existing codes.
2. Use the filters and/or hierarchy breadcrumb to locate the code(s) to delete.
3. You can either select the code(s) from the list view via the check boxes and click **Delete** OR open the appropriate code and click **Delete**.

8.8.3. Forced Authorization Code (FAC) Management using VOSS-4-UC

The VOSS-4-UC FAC management feature and workflows push any added FAC codes to all the clusters at that hierarchy (e.g. all clusters at a customer). This means for deployments where consistent FAC codes are being used, these don't need to be managed per cluster by administrators.

The same applies for the delete FAC code scenario where you have the choice to remove it from a single cluster or all the clusters at that hierarchy level.

There is also a sync capability in the event that a new cluster is added and the existing codes needs to be pushed to the new cluster. This mode can be used for single cluster environments as well if needed.

The ability to define the relevant FAC code authorization levels and provide text naming for them helps to provide appropriate business context to the level for administrators.

By default VOSS-4-UC includes all the levels for use, however you can adjust these to your needs. For example, you can configure FAC so that only five levels are shown and they have the correct naming convention, e.g. 6 - International. See [Customize Authorization Levels](#) for more details.

Use this feature to manage FAC codes:

- Add a code to all clusters - browse to the level you want the code added. Use the view to enter the details for the code - the list of authorization levels is driven by the setup above. Click **Add**. This adds the FAC code to any cluster at that hierarchy level - so if there are three clusters at level, the code will be added to all three clusters.

If the hierarchy only has a single cluster or is not a multi-cluster environment, then the code is only added to the single cluster.

- Add a code to only a single cluster.
- Update a code - open, edit and save- this will change the code on all clusters.
- Remove a code - from a single cluster or across all clusters.

Add a Forced Authorization Code

1. Navigate to the required customer or site level.
2. From the **Forced Authorization Codes** form (default menu **Device Management > CUCM FAC Management > Forced Authorization Codes**).
3. Click **Add**.
4. Complete the following mandatory settings (see form **Help notes** for additional information):

A Provider Admin can customize the form help by cloning, editing and saving the help text on the **Customize Help** form to a lower hierarchy level.

Field Name	Description
Name*	A unique name describing the FAC code, e.g. Customer code + Subscriber UserID. This name ties the authorization code to a specific user or group of users; and displays in the CDRs for calls that use this code. 50 characters maximum.
Authorization Level*	Select the authorization level in the range of 0 to 255. This can include a description after a delimiter, e.g. 1-international ¹ . The drop-down contains all authorization levels that have been cloned to this hierarchy level. If none have been cloned, then the list displays the default auth levels 0-255. To successfully route a call, the user's Authorization Level must be equal to or greater than the Authorization Level set on the Route Pattern.
Code*	Enter a unique authorization code. The user enters this code when placing a call through a FAC-enabled route pattern. 16 digits maximum.

5. Click **Save** and inspect the entry in the list view.

¹ See [Customize Authorization Levels](#)

Delete a Forced Authorization Code

When deleting FAC codes, all codes are listed for each Unified CM cluster. This allows the deletion of a code on a single cluster, even if it was added at customer level to multiple clusters.

1. Browse to the required customer or site hierarchy.
2. Open the **Forced Authorization Codes** form (default menu **Device Management > CUCM FAC Management > Forced Authorization Codes**)
3. Select the check box next to the FAC instance you want to delete or click on the FAC instance you want to delete.
4. Click **Delete** and then click **Yes** to confirm deletion.

Note: All instances of a FAC can also be deleted (across all clusters) by selecting the instance on the list view, and then clicking **Delete All Instances** on the button bar.

Sync Forced Authorization Code Cross Cluster

All codes can be synced across **all clusters** at the customer hierarchy.

1. Browse to the required customer hierarchy.
2. Open the **Sync FAC Codes Cross Clusters** form (default menu **Device Management > CUCM FAC Management > Sync FAC Codes Cross Clusters**).
3. Select the **Confirm** check box and click **Save**.

8.8.4. Customize Authorization Levels

Open the **Customize Authorization Levels** form (default menu **Apps Management > CUCM FAC Management > Customize Authorization Levels**) to access the list of valid authorization (auth) levels and optional text. These instances are hierarchy specific so you can have different codes/text for different hierarchies, e.g. different customers or areas of the business.

The list of auth levels available in the drop-down can be customized. By default, numeric values 0 to 250 are shown.

If a Customer only requires for example 0 to 6 auth levels, then a provider administrator can clone, edit and save those instances to the lower hierarchy level. Descriptive text can also be added to the cloned auth level first by adding a '-' and then a 'description' *after* the numeric value, for example:

1-Allow Local Calls, where:

- '1' is the numeric value that gets selected on the Unified CM
- '-' is the delimiter that separates the numeric value and description
- 'Allow Local Calls'- is the (example) friendly description that describes the numeric value action

Once cloned to Customer level, only the cloned versions are displayed in the **Authorization Level** drop-down when adding forced authorization code at Customer level or lower.

8.9. CUC (Cisco Unity Connection)

8.9.1. Set up Cisco Unity Connection

Overview

Cisco Unity Connection devices provide voicemail services for HCS deployments, and can be dedicated to a customer or shared across multiple customers. To dedicate a Cisco Unity Connection to a single customer, configure the Cisco Unity Connection at the customer hierarchy node. To share a Cisco Unity Connection across multiple customers, configure the Cisco Unity Connection at a hierarchy node above the customer (reseller, provider, or intermediate node). The Cisco Unity Connection device must be included in one or more Network Device Lists (NDLs), and the NDL must be assigned to one or more sites.

Synchronization with VOSS-4-UC

Configuring a Cisco Unity Connection device on VOSS-4-UC creates a scheduled data sync to import model data from the device into VOSS-4-UC. The scheduled data sync ensures that the VOSS-4-UC cache maintains the most current view of the configured device. Any changes to the configuration occurring on the device, including additions, deletions, or modifications, will be reflected in VOSS-4-UC after the next data sync.

Note:

- There is no immediate data sync upon Update or Modification.
- Some license-related models will now be excluded from Cisco Unity Connection imports by default:
 - `device/cuc/Handler`
 - `device/cuc/GlobalUser`
 - `device/cuc/LicenseStatus`
 - `device/cuc/TenantUserLicense`
 - `device/cuc/UserLicense`

The recurring sync is scheduled to occur every 14 days, but is disabled by default. You can enable the sync and modify the schedule from **Apps Management > CUC > Schedules**. When determining the appropriate schedule setting, the frequency of the sync must be weighed against the additional processing and network activity associated with the data sync. You can also manually run the data sync at any time from **Apps Management > Advanced > Perform Publisher Actions**, or from **Administration Tools > Data Sync**.

Important: Allow the initial data sync to complete before doing more configuration on VOSS-4-UC that requires information from Cisco Unity Connection.

The performance of a data sync can be improved by controlling the types of data that are synced. See [Controlling a Data Sync with a Model Type List](#) for more information.

Note: References to HCM-F and Shared Data Repository (SDR) are only relevant if installed.

Perform these steps:

1. Log in as the appropriate hierarchy administrator.
Only a provider or reseller administrator can create a shared instance. A customer, provider, or reseller administrator can create a dedicated instance.
2. Set the hierarchy path to the correct level. Create a shared instance at the provider or reseller level. Create a dedicated instance at the customer level.
3. Choose **Apps Management > CUC > Servers**.
4. Click **Add**.
5. Enter a Cisco Unity Connection server name in the **CUC Server Name** field.

Note: A Cisco Unity Connection server that has been configured in HCM-F and synced into VOSS-4-UC may exist at the sys.hcs hierarchy. If the server name you enter matches this server, the **Migrate from HCM-F to VOSS-4-UC** check box is displayed. Click **Save** to migrate this server to the current hierarchy level. The fields are populated with the values that were configured in HCM-F. If you do not want to migrate the server, enter a different server name.

6. Select the **Publisher** check box if you are configuring a publisher node.

Note:

The **Publisher** tab is populated only when the **Publisher** check box is selected.

On the **Publisher** tab, you can specify the following information:

Field	Description
Prime Collab	Select the Prime Collaboration management application monitoring this cluster. To unassociate Prime Collaboration for this cluster, select None.
Call Processing ID	The Call Processing ID of this cluster
Cluster ID	The Cluster ID of this cluster.
Multi-Tenant	If creating at provider level, this field is read-only and set to Shared. If creating at customer level, you can choose between Dedicated and Partitioned.
Version	Select the version of Cisco Unity Connection Servers in this cluster. The available versions depend on the version of HCM-F that has been configured.
Port	The port on the Cisco Unity Connection server to connect to. Default is 8443.
Monitoring	For new servers and if arbitrator servers are available, monitoring can be enabled for this Unity Connection server on VOSS Assurance. The arbitrator server check boxes can be selected to add the server as an asset. The arbitrator server will be updated. Existing servers can be managed from the Onboard Assets and Offboard Assets menus under VOSS Assurance. The arbitrator checkboxes will then reflect the asset status.

Note: For details on monitoring and VOSS Assurance and Analytics, see [VOSS Assurance Monitoring Overview](#).

7. Fill in the **Cluster Name** field with the name you want for this cluster. A new cluster is created with this name. This field is mandatory.

Note: If the **Publisher** check box is not selected, the **Cluster Name** field appears as a drop-down list, from which you choose an existing cluster.

8. Expand **Network Addresses**.

- a. Choose the SERVICE_PROVIDER_SPACE address space.
- b. The **Hostname** field is automatically populated with the Cisco Unity Connection Server Name. Edit it if necessary.
- c. Enter the IP address of the Cisco Unity Connection Server in the **IPV4 Address** field.

Note: Either the hostname or the IP address is required. Ensure that the hostname or IP address does not contain a trailing blank space. VOSS-4-UC cannot validate an entry that contains a blank space at the end of the hostname or IP address.

- d. Fill in the domain of the Cisco Unity Connection application.
- e. Provide an optional description for the network address.

If NAT is used, also configure an APPLICATION_SPACE network address.

9. Expand **Credentials**.

- a. Add credentials for PLATFORM, ADMIN, HTTP, and SNMP_Vx credential types. Click + to add more credentials.
- b. Fill in the user ID and password that you configured when you installed the Cisco Unity Connection.
- c. Choose RO (Read-only) or RW (Read or Write) for the Access Type. The default is RO.
- d. Provide an optional description for the credential.

- ADMIN credentials are used by VOSS-4-UC to access the Cisco Unity Connection REST API interface for provisioning synchronization.
- PLATFORM credentials are used by HCM-F (HLM service) to set the deployment mode and restart the publisher.
- ADMIN, HTTP, and SNMP are required for PCA to manage Cisco Unity Connection. These credentials must be manually configured in Cisco Unity Connection, then configured in VOSS-4-UC's **Device Management > CUC > Servers > Credentials** section.
- PLATFORM and ADMIN are required for Service Inventory to generate reports for UC applications.

10. Click **Save**.

8.9.2. Cisco Unity Connection Server Deletion

Deleting a Cisco Unity Connection Server in VOSS-4-UC also deletes local data that has been synced to it from the Cisco Unity Connection Server, including:

- Users
- Configuration parameters
- Dial Plan information (if applicable)

8.10. CER (Cisco Emergency Responder)

8.10.1. Set Up Cisco Emergency Responder: Overview

Complete this procedure at any time to configure Cisco Emergency Responder (CER) on VOSS-4-UC. For more information on CER installation and setup, refer to the Cisco Emergency Responder Administration Guide.

Note: References to HCM-F and Shared Data Repository (SDR) are only relevant if installed.

Perform these steps:

1. Log in as the appropriate hierarchy administrator.
2. Set the hierarchy path to the correct level. Shared instances are created at the provider, reseller, or customer level. Dedicated instances are created at the customer level.
3. Choose **Apps Management > CER > Servers**.
4. Perform one of the following:
 - To add a new Cisco Emergency Responder (CER) in VOSS-4-UC, click **Add**.
 - To modify an existing CER, click its name in the list of Cisco Emergency Responders.
5. Enter a name for the Cisco Emergency Responder in the **CER_Virtual Server Name** field.

Note:

A Cisco Emergency Responder server that has been configured in HCM-F and synced into VOSS-4-UC may exist at the sys.hcs hierarchy. If the server name you enter matches this server, the **Migrate from HCM-F to VOSS-4-UC** check box is displayed. Click **Save** to migrate this server to the current hierarchy level. The fields will be populated with the values that were configured in HCM-F. If you do not want to migrate the server, enter a different server name.

6. Select the **Publisher** check box if you are configuring a publisher node.

Note:

The **Publisher** tab is populated only when the **Publisher** check box is selected.

7. Expand **Network Addresses**.
 - a. Choose the SERVICE_PROVIDER_SPACE address space.
 - b. Enter the IP address of the CER Server in the **IPV4 Address** field.

Note:

Either the hostname or the IP address is required. Ensure that the hostname or IP address does not contain a trailing blank space. VOSS-4-UC cannot validate an entry that contains a blank space at the end of the hostname or IP address.

- c. The **Hostname** field is automatically populated with the CER Name. Edit it if necessary.
 - d. Fill in the domain of the CER application.
 - e. Provide an optional description for the network address.
8. Expand **Credentials**.

- a. Add credentials for PLATFORM and ADMIN credential types. Click + to add more credentials.
- b. Fill in the user ID and password that you configured when you installed the CER.
- c. Choose RO (Read-only) or RW (Read or Write) for the Access Type. The default is RO.
- d. Provide an optional description for the credential.

PLATFORM and ADMIN are required for license management.

9. On the **Publisher** tab, you can specify the following information:

Field	Description
Version	Select the version of the Cisco Emergency Responder Servers in this cluster. The available versions depend on the version of the HCM-F device that has been configured.
Multi-Tenant	Read-only field. If creating at provider level, this field is set to Shared. If creating at customer level, this field is set to Dedicated.

10. Click **Save**.

Next Steps:

- Associate CER with Customers

8.10.2. Associate CER with Customers

Prerequisites:

- A customer must be configured.
- Perform this procedure at any hierarchy level at or above where the CER is configured, when you configure the VM in Cisco Unified Communications Domain Manager 10.6(x), or perform it at any time after the VM has been created.

Perform these steps:

1. Log in as a Provider or Reseller administrator.
2. Choose **Device Management > CER > Servers**.
3. Click the name of the CER cluster to associate with a customer.
4. Click the **Customer Association** tab.

Note:

The list of customers that appear on this tab are those at, and below your current hierarchy. For example, if you are at the Provider level, and the CER is at Reseller1, you can see all customers at the Provider level and below. An error will occur if you try to associate a customer out of the CER's scope.

5. Select the check box to the left of each customer to be associated with the CER cluster.

Note: To remove one or more customer associations from the CER cluster, clear the box for each customer to be disassociated from the cluster.

6. Click **Save**.

8.10.3. View Associated Clusters on CER Servers

Prerequisites:

- Customers must be associated with the Cisco Emergency Responder (CER) cluster in order to be viewed in this procedure, unless the CER is created at customer level.
- If the CER is created at the customer level, customer information is automatically filled in for the customer where the CER exists.

Perform these steps:

1. Log in as a Provider, Reseller, or Customer administrator.
2. Make sure that the hierarchy is set to the customer you wish to view.
3. Choose **Device Management > CER > Servers**.
4. Click the name of the CER cluster to be viewed. Information appears about the CER cluster. You can view a list of customers associated with the CER server by selecting the Customer Association tab.

8.11. CCX (Cisco Contact Center Express)

8.11.1. Contact Center Servers

Contact Center Management

Reseller level and higher administrators can view and manage Cisco Unified Contact Center Express (CCX) servers, typically from the **Apps Management** menu.

Note:

- Network Device Lists must always be updated to include the CCX server, even when a single server is used per customer.
- Multiple CCX servers can be configured for a single customer. In this case, the relevant Network Device Lists be updated with the CCX server references.
- Cisco Unified CM and CCX server integration should also be carried out as pre-configuration for this feature to work correctly.

Set Up a Contact Center Server

1. Log in as provider administrator or higher and navigate to the required hierarchy.
2. Click the **Add** button and fill in the server details on the input form.
 - The current supported **Versions** are 11.x and 12.x.
 - Set the **Application User ID** values of the server. These are Cisco UCM Application users to be used for agent device association. Typically this would be the RMCM application user (CCX Resource Manager, Unified CM Telephony user), but could also include others for call recording and so on.

Data Sync of Contact Center Server

When the Contact Center server is added, you can run a pull data sync from the server to VOSS-4-UC. This can be done from the Contact Center Server input interface menu: **Actions > Sync**.

In addition, VOSS-4-UC also automatically creates two default Data Sync instances to manage and schedule data synchronization between the device and VOSS-4-UC. These can be seen from the **Data Sync** list view:

- *SyncUccx-<host>*: use this sync to schedule or manually sync data between the server and VOSS-4-UC.
- *PurgeUCcx-<host>*: disabled by default to avoid accidental purges. It and can be enabled by changing the Sync Type to “Purge Local Resources” from “Pull from Device” and by clearing the **Disabled Operations**.

The Data Sync instances will be removed automatically when the server is deleted. The purge sync will also be executed on server deletion, thereby removing any configuration from the VOSS-4-UC system.

8.12. Prime Collab (Cisco PCA)

8.12.1. Role Mapping for Prime Collaboration Assurance

Service providers deploying VOSS-4-UC use role-based access control (RBAC) to restrict certain management actions to a specific set of users. Administrators at each level have access to the information in all hierarchy levels below them.

Prime Collaboration Assurance roles are hierarchical in the following order:

1. Super Administrator - Includes all privileges of System Administrator, Network Administrator, Operator, and Help Desk, along with the Super Administrator permissions.
2. System Administrator.
3. Network Administrator - Includes all privileges of Operator and Help Desk, along with the Network Administrator permissions.
4. Operator - Read-only administrative access.
5. Help Desk.

VOSS-4-UC roles map to the Prime Collaboration Assurance roles shown in the following table. You can find Roles in VOSS-4-UC under **Role Management > Roles**. The three drop-down lists that are important in VOSS-4-UC are **Hierarchy Type**, **Service Assurance Role Type**, and **HCS Component Access**.

Prime Collaboration Assurance roles are shown in this table in hierarchical order from top to bottom. The role shown in BOLD represents the highest role available.

Role Mapping Between VOSS-4-UC and Prime Collaboration Assurance

Hierarchy Type in VOSS-4-UC	Service Assurance Role Type	HCS Component Access	Prime Collaboration Assurance Role	Notes
Provider	Administrator	Fulfillment and Service Assurance	Super Administrator , System Administrator, Network Administrator	Provider roles are always the top organization unit in the VOSS-4-UC navigation tree. The Provider roles can see all devices, including shared devices such as Cisco Unified Border Element (SP Edition). A Provider with this role has Administrative level access to VOSS-4-UC and Prime Collaboration Assurance.
				A Provider with this role has Administrative
		Service Assurance Only		level access to VOSS-4-UC and Prime Collaboration Assurance.
		Fulfillment Only	Not Applicable	A Provider with this role has Administrative level access to VOSS-4-UC.
	Operator	Fulfillment and Service	Operator , Help Desk	A Provider with this role has Administrative level read-only access to VOSS-4-UC and Prime Collaboration Assurance.

Hierarchy Type in VOSS-4-UC	Service Assurance Role Type	HCS Component Access	Prime Collaboration Assurance Role	Notes
		Service Assurance Only		A Provider with this role has Administrative level read-only access to VOSS-4-UC and Prime Collaboration Assurance.
		Fulfillment Only	Not Applicable	A Provider with this role has Administrative level read-only access to VOSS-4-UC.
Reseller	Administrator	Fulfillment and Service Assurance	Network Administrator	These roles can only see the customer information that belongs to your Reseller organization. A Reseller with this role has Administrative level access to VOSS-4-UC and Prime Collaboration Assurance.
		Service Assurance Only	Network Administrator	A Reseller with this role has Administrative level access to VOSS-4-UC and Prime Collaboration Assurance.
		Fulfillment Only	Not Applicable	A Reseller with this role role has Administrative level access to VOSS-4-UC.

Hierarchy Type in VOSS-4-UC	Service Assurance Role Type	HCS Component Access	Prime Collaboration Assurance Role	Notes
	Operator	Fulfillment and Service Assurance	Operator, Help Desk	A Reseller with this role has Administrative level read-only access to VOSS-4-UC, Hosted Collaboration Mediation-Fulfillment, and Prime Collaboration Assurance.
		Service Assurance Only	Operator, Help Desk	A Reseller with this role has Administrative level read-only access to VOSS-4-UC and Prime Collaboration Assurance.
		Fulfillment Only	Not Applicable	A Reseller with this role has Administrative level read-only access to VOSS-4-UC and Hosted Collaboration Mediation-Fulfillment.
Customer	Administrator	Fulfillment and Service Assurance	Network Administrator	With this role you can only see your own customer information. A Customer with this role has Administrative level access to VOSS-4-UC, Hosted Collaboration Mediation-Fulfillment, and Prime Collaboration Assurance.
		Service Assurance Only	Network Administrator	A Customer with this role has Administrative level access to to VOSS-4-UC and Prime Collaboration Assurance.

Hierarchy Type in VOSS-4-UC	Service Assurance Role Type	HCS Component Access	Prime Collaboration Assurance Role	Notes
		Fulfillment Only	Not Applicable	A Customer with this role has Administrative level access to VOSS-4-UC and Hosted Collaboration Mediation-Fulfillment.
	Operator	Fulfillment and Service Assurance	Operator, Help Desk	A Customer with this role has Administrative level read-only access to VOSS-4-UC, Hosted Collaboration Mediation-Fulfillment, and Prime Collaboration Assurance.
		Service Assurance Only	Operator, Help Desk	A Customer with this role has Administrative level read-only access to VOSS-4-UC and Prime Collaboration Assurance.
		Fulfillment Only	Not Applicable	A Customer with this role has Administrative level read-only access to VOSS-4-UC and Hosted Collaboration Mediation-Fulfillment.

8.12.2. Prime Collaboration Assurance Integration

Before You Begin

- Review Role Mapping for Prime Collaboration Assurance to understand how your VOSS-4-UC roles map to Prime Collaboration Assurance roles.
- In Prime Collaboration Assurance, enable SFTP. SFTP is not enabled by default.
- Ensure that the smuser account is available in the Prime Collaboration Assurance, and you can log in. The default SFTP credential in PCA is smuser/smuse.

Use this workflow to integrate VOSS-4-UC with Prime Collaboration Assurance.

Procedure

1. Configure Prime Collaboration Assurance.
2. Set up Prime Collaboration Assurance to monitor the Unified Computing System.
3. Add the Service Provider space and Application space under Address space information when adding Cisco Unity Connection and Cisco IM and Presence server to VOSS-4-UC. Prime Collaboration Assurance uses the server's Service provider space to monitor the applications. See [Set Up IM and Presence Service Servers](#).
4. Add Cisco IM and Presence Service subnode information to VOSS-4-UC if you have multiple instances of Cisco IM and Presence Service deployed.
5. Ensure that your Unified Communications applications have all the needed credentials. At a minimum, you require credentials for Administration, platform, SNMP, JTAPI, and HTTP.

Note:

Depending on what you are monitoring, other credentials may be needed. For more information about the required protocols, support, and credentials to set up devices for Prime Collaboration Assurance monitoring, see:

http://docwiki.cisco.com/wiki/Setting_up_Devices_for_Prime_Collaboration_Assurance.

6. Synchronize your customer information with VOSS-4-UC. See *Set Up Cisco Unified Communications Manager Servers* for more information.
7. (Optional) Ensure that the Session Border Controller has the required credentials in Hosted Collaboration Mediation-Fulfillment.
8. Ensure that the CPE (analog gateway or LBO) has the required credentials in VOSS-4-UC under Devices.
9. Enter the SNMP commands manually on the Local Break Out (LBO) gateway or analog gateway. This task is required to manage the LBO gateway and analog gateway in Prime Collaboration Assurance.

Note:

IOS default command builder does not generate SNMP commands. The administrator must enter SNMP commands.

10. Add Prime Collaboration Assurance to VOSS-4-UC (**Device Management > Prime Collab > Servers**). (Administration and SFTP credentials are required.)
11. Onboard the customer to Prime Collaboration Assurance using the Cisco Unified Communications Manager administrative interface. CHPA pushes SNMP, Syslog, and Billing server configuration information to your VOSS-4-UC automatically. Add Syslog and SNMP configurations manually for Cisco Unity Connection and IM and Presence Service before onboarding.

Note:

Configure these credentials in Unified CM nodes to ensure a successful CHPA configuration:

- Administration credentials for Unified CM
- Platform credentials for Unified CM
- SNMP and HTTP credentials for Unified CM
- SFTP for Prime Collaboration Assurance

Note:

This configuration is pushed to Unified CM:

- The SNMP community string
- CDR (SFTP of the Prime Collaboration Assurance server)
- Syslog configuration

Note:

JTAPI credentials are optional credentials used for TelePresence session monitoring. They are used to retrieve session status information from TelePresence devices. Create a JTAPI user in the Unified Communications Manager with the required permission to receive JTAPI events on endpoints. The credentials must be manually configured in Unified CM. Note also that Prime Collaboration Assurance manages multiple call processor clusters and as a result you must ensure that the cluster IDs are unique.

12. Synchronize Active Directory users with VOSS-4-UC.

Note: Only users at the provider hierarchy are pushed to PCA.

13. To confirm if the Cisco HCM-F (if installed) push and subsequent Device Discovery were successful, verify that the devices are managed in Prime Collaboration Assurance. Review the Current Inventory table at **Operate > Device Work Center** (Prime Collaboration Assurance 10.5.1) or **Device Inventory > Inventory Management** (Prime Collaboration Assurance 11.5 or later). Devices appear in **Inventory Management** with the Managed status. For details on the Prime Collaboration Assurance Inventory table, see the **Manage Inventory** section of Cisco Prime Collaboration Assurance Guide Advanced, available at:

<http://www.cisco.com/c/en/us/support/cloud-systems-management/prime-collaboration/products-user-guide-list.html>.

Note:

In Cisco HCM-F (if installed), you may receive a **Credential-related error message**, but there can be other reasons for this error, such as a firewall issue. We recommend that you use Prime Collaboration Assurance to verify that devices are managed. If a device is not going into the managed state successfully, refer to the **Troubleshooting** section of the **Discover Devices** chapter in Cisco Prime Collaboration Assurance Guide Advanced for troubleshooting tips.

A list of the devices supported by Prime Collaboration Assurance is available at:

<http://www.cisco.com/c/en/us/support/cloud-systems-management/prime-collaboration/products-device-support-tables-list.html>.

14. Check the Prime Collaboration Assurance dashboard.

See **UC Performance Monitor Dashboards** in the Cisco Prime Collaboration Assurance Guide Standard or Cisco Prime Collaboration Assurance Guide Advanced.

15. Monitor components and devices with Prime Collaboration Assurance.

8.13. IOS

8.13.1. IOS Device Management: Overview

In VOSS-4-UC, you can set up IOS devices such as SIP Local Gateways and Analog Gateways. You can set up Command Builders to generate the appropriate IOS commands for you to copy to the IOS device CLI.

8.13.2. Command Builders Overview

You can build a repository of IOS commands to be run when certain events, such as adding an IOS device, occur. Each set of IOS commands and associated event is known as a Command Builder. For a list of events with default set of IOS commands and available variables, see *Local Break Out and Analog Gateway Events, IOS Commands, and Variables*. The default Command Builders exist at the sys.hcs hierarchy level.

You can define customized Command Builders at any hierarchy node. When an event occurs, Command Builders nearest (at or above) the hierarchy node of the event are checked first. For instance, if an event occurs at a customer hierarchy level, Command Builders at the customer level are checked before Command Builders at the provider or sys.hcs level. Command Builders at a higher level are checked only if no builders match at a nearer hierarchy level. If no customized Command Builders are defined, the default Command Builders at sys.hcs are checked. Multiple Command Builders may be run for the same event at the same hierarchy node.

8.13.3. LBO and Analog Gateway Configuration and Generated Events

LBO and Analog Gateway Configuration and Corresponding Events

Event	Configuration
LBO and Analog Gateway Configuration Action	Generated LBO and Analog Gateway Events
Add an IOS Device	HcsAddIOSDeviceEVT
Delete an IOS Device	HcsDeleteIOSDeviceEVT
Add an Analog Device	HcsAddAnalogGatewayEVT
Add an Analog Gateway Endpoint	HcsAddAnalogGatewayEndpointEVT
Add an Analog Gateway Endpoint Mod	HcsAddAnalogGatewayEndpointModEVT
Delete an Analog Gateway	HcsDeleteAnalogGatewayEVT
Delete an Analog Gateway Endpoint	HcsDeleteAnalogGatewayEndpointEVT
Delete an Analog Gateway Endpoint Mod	HcsDeleteAnalogGatewayEndpointModEVT

8.13.4. Local Break Out and Analog Gateway Events, IOS Commands, and Variables

Local Break Out and Analog Gateway Events

Default IOS Commands	Notes
HcsAddIOSDeviceEVT An IOS Device is added.	
<pre> conf t voice service VoIP no IP address trusted authenticate y fax protocol t38 ls-redundancy 0 hs-redundancy 0 ↳fallback pass-through g711ulaw modem passthrough nse codec g711ulaw voice class codec 1 codec preference 1 g729r8 bytes 30 codec preference 2 g711ulaw codec preference 3 g711alaw end </pre>	<p>If you are generating the command for VG350 analog gateway, remove y from the generated commands, and then paste it to the analog gateway console.</p>

Default IOS Commands
HcsDeleteIOSDeviceEVT An IOS Device is deleted.
<pre> conf t no voice service VoIP no voice class codec 1 end </pre>

Default IOS Commands	Available Variables
<pre> HcsAddAnalogGatewayEVT An Analog Gateway is added. conf t stcapp ccm-group 1 stcapp stcapp feature access-code stcapp feature speed-dial sccp local {{ pwf.GatewayDAT.networkInterface }} sccp bind interface {{ pwf.GatewayDAT.networkInterface }} sccp ccm group 1 {{ macro.HcsAnalogGwCommandForCCMIdentAndAssocMCR }} ↪ ccm-manager config server {{ fn.one macro. ↪HcsCucmsAssociatedToNDLRMCR}} ccm-manager sccp local {{ pwf.GatewayDAT. ↪networkInterface }} ccm-manager sccp stcapp end </pre>	<p>pwf.GatewayDAT.networkInterface - This is the physical device network interface (Ethernet Port) for the analog gateway.</p>

Default IOS Commands	Available Variables
<p>HcsAddAnalogGatewayEndpointEVT An Endpoint is added for the Analog Gateway.</p> <pre> conf t voice-port {{ pwf.PORT_NUM }} caller-id enable timeouts call-disconnect {{ fn.as_string pwf.GatewayDAT.disconnectTimeout }} cptone {{ pwf.GatewayDAT.cpTone }} signal {{macro.HcsIosCmdAnalogGwSignalMCR}} no shutdown dial-peer voice {{ pwf.DIAL_PEER_NO }} pots service stcapp port {{ pwf.PORT_NUM }} end </pre>	<p>pwf.PORT_NUM - This is the FXS port number of the analog gateway device.</p> <p>pwf.GatewayDAT.disconnectTimeout - Time in seconds for which a connection is maintained after the completion of a communication exchange.</p> <p>pwf.GatewayDAT.cpTone - This is the call progress tone of the country that supports each analog device in the gateway.</p> <p>pwf.DIAL_PEER_NO - returns the dial peer number we use to generate dial peer. It starts from 4 for the first dial peer, and increase by 1 for the next one.</p>

Default IOS Commands	Available Variables
HcsAddAnalogGatewayEndpointModEVT An Endpoint Module is added for the Analog Gateway.	
<pre> conf t voice-port {{ pwf.PORT_NUM }} caller-id enable timeouts call-disconnect {{ fn.as_string pwf.GatewayDAT.disconnectTimeout }} cptone {{ pwf.GatewayDAT.cpTone }} signal {{macro.HcsIosCmdAnalogGwSignalMCR}} no shutdown dial-peer voice {{ pwf.DIAL_PEER_NO }} pots service stcapp port {{ pwf.PORT_NUM }} end </pre>	<p>pwf.PORT_NUM - This is the FXS port number of the analog gateway device.</p> <p>pwf.GatewayDAT.cpTone - This is the call progress tone of the country that supports each analog device in the gateway.</p> <p>pwf.GatewayDAT.disconnectTimeout - Time in seconds for which a connection is maintained after the completion of a communication exchange.</p> <p>pwf.DIAL_PEER_NO - returns the dial peer number we use to generate dial peer. It starts from 4 for the first dial peer, and increase by 1 for the next one.</p>

Default IOS Commands
HcsDeleteAnalogGatewayEVT An Analog Gateway is deleted.
<pre> conf t no stcapp no ccm-manager sccp local {{ input.GatewayDAT.networkInterface }} no ccm-manager sccp no sccp no sccp local {{ input.GatewayDAT.networkInterface }} no sccp ccm group 1 end </pre>

Default IOS Commands	Available Variables
HcsDeleteAnalogGatewayEndpointEVT An Analog Gateway Endpoint is deleted.	
<pre> conf t voice-port {{ pwf.PORT_NUM }} no caller-id enable no timeouts call-disconnect no cptone no signal shutdown no dial-peer voice {{ pwf.DIAL_PEER_NO }} pots no port {{ pwf.PORT_NUM }} end </pre>	<p>pwf.PORT_NUM - This is the FXS port number of the analog gateway device.</p> <p>pwf.DIAL_PEER_NO - returns the dial peer number we use to generate dial peer. It starts from 4 for the first dial peer, and increase by 1 for the next one.</p>

Default IOS Commands	Available Variables
HcsDeleteAnalogGatewayEndpointModEVT An Analog Gateway Endpoint Module is deleted.	
<pre> conf t voice-port {{ pwf.PORT_NUM }} no caller-id enable no timeouts call-disconnect no cptone no signal shutdown no dial-peer voice {{ pwf.DIAL_PEER_NO }} pots no port {{ pwf.PORT_NUM }} end </pre>	<p>pwf.PORT_NUM - This is the FXS port number of the analog gateway device.</p> <p>pwf.DIAL_PEER_NO - returns the dial peer number we use to generate dial peer. It starts from 4 for the first dial peer, and increase by 1 for the next one.</p>

8.13.5. MGCP Analog Gateway Events and IOS Commands

MGCP Analog Gateway Events

Default IOS Commands	Available Variables
<p>HcsAddAnalogGatewayEVT Adds an Analog MGCP Gateway.</p> <pre> conf t hostname {{pwf.GatewayDAT.domainName}} ccm-manager config server {{ fn.one macro. ↳HcsCucmsAssociatedToNDLRMCR}} ccm-manager config mgcp call-agent {{ fn.one macro. ↳HcsCucmsAssociatedToNDLRMCR}} 2427 service-type_ ↳mgcp version 1.0 ccm-manager mgcp ! ccm-manager redundant-host ccm-manager switchback Graceful ccm-manager fallback-mgcp mgcp bind control source-int {{ pwf.GatewayDAT. ↳networkInterface }} mgcp bind media source-int {{ pwf.GatewayDAT. ↳networkInterface }} mgcp dtmf-relay voip codec all mode out-of-band mgcp modem passthrough voip mode nse mgcp package-capability sst-package no mgcp package-capability sst-package end </pre>	<p>pwf.GatewayDAT.networkInterface returns the Network Interface based on the configuration in the Gateway.</p>

Default IOS Commands	Available Variables
<p>HcsAddAnalogGatewayEndpointEVT Adds an Endpoint for the Analog MGCP Gateway.</p> <pre> conf t voice-port {{ pwf.PORT_NUM }} timeouts call-disconnect {{ fn.as_string pwf. ↳GatewayDAT.disconnectTimeout }} cptone {{ pwf.GatewayDAT.cpTone }} signal {macro.HcsIosCmdAnalogGwSignalMCR}} ring frequency 25 description {{ fn.sub_string macro. ↳HcsAnalogGatewayIOSCmdDesc, 0, 63 }} timing hookflash-in 250 80 no shutdown exit dial-peer voice {{ pwf.DIAL_PEER_NO }} pots service mgcpapp port {{ pwf.PORT_NUM }} end </pre>	<p>pwf.GatewayDAT.cpTone - This is the call progress tone of the country that supports each analog device in the gateway. pwf.DIAL_PEER_NO - returns the dial peer number that is used to generate the dial peer. It starts from 4 for the first dial peer, and increase by 1 for the next one.</p>

Default IOS Commands	Available Variables
<p>HcsAddAnalogMGCPGatewayEndpointModEVT Adds an Endpoint Module for the Analog MGCP gateway.</p> <pre> conf t voice-port {{ pwf.PORT_NUM }} timeouts call-disconnect {{ fn.as_string pwf. ↳GatewayDAT.disconnectTimeout }} cptone {{ pwf.GatewayDAT.cpTone }} signal {{macro.HcsIosCmdAnalogGwSignalMCR}} ring frequency 25 description {{ fn.sub_string macro. ↳HcsAnalogGatewayIOSCmdDesc, 0, 63 }} timing hookflash-in 250 80 no shutdown exit dial-peer voice {{ pwf.DIAL_PEER_NO }} pots service mgcpapp port {{ pwf.PORT_NUM }} end </pre>	<p>pwf.PORT_NUM - This is the FXS port number of the analog gateway device.</p> <p>pwf.GatewayDAT.disconnectTimeout - Time in seconds for which a connection is maintained after the completion of a communication exchange.</p> <p>pwf.GatewayDAT.cpTone - This is the call progress tone of the country that supports each analog device in the gateway.</p> <p>pwf.DIAL_PEER_NO - returns the dial peer number we use to generate dial peer. It starts from 4 for the first dial peer, and increase by 1 for the next one.</p>

Default IOS Commands	Available Variables
<p>HcsDeleteAnalogGatewayEVT Deletes an Analog MGCP Gateway.</p> <pre> conf t no mgcp call-agent {{ fn.one macro. ↳HcsCucmsAssociatedToNDLRMCR}} 2427 service-type_ ↳mgcp version 1.0 no ccm-manager config server {{ fn.one macro. ↳HcsCucmsAssociatedToNDLRMCR}} mgcp no ccm-manager mgcp ! no ccm-manager redundant-host no ccm-manager switchback Graceful no ccm-manager fallback-mgcp no mgcp bind control source-int {{ pwf.GatewayDAT. ↳networkInterface }} no mgcp bind media source-int {{ pwf.GatewayDAT. ↳networkInterface }} no mgcp dtmf-relay voip codec all mode out-of-band no mgcp modem passthrough voip mode nse no ccm- ↳manager music-on-hold no ccm-manager config no mgcp package-capability rtp-package no mgcp package-capability sst-package no mgcp default-package mt-package no mgcp timer receive-rtcp no mgcp sdp simple no mgcp fax t38 inhibit no mgcp end </pre>	<p>pwf.GatewayDAT.networkInterface - This is the physical device network interface (Ethernet Port) for the analog gateway.</p>

Default IOS Commands	Available Variables
HcsDeleteAnalogGatewayEndpointEVT Deletes an Endpoint for the Analog MGCP Gateway.	
<pre>conf t voice-port {{ pwf.PORT_NUM }} no timeouts call-disconnect default cptone default timing hookflash-in default description no signal default ring frequency shutdown exit no dial-peer voice {{ pwf.DIAL_PEER_NO }} pots end</pre>	<p>pwf.PORT_NUM - This is the FXS port number of the analog gateway device.</p> <p>pwf.DIAL_PEER_NO - returns the dial peer number we use to generate dial peer. It starts from 4 for the first dial peer, and increase by 1 for the next one.</p>

Default IOS Commands	Available Variables
HcsDeleteAnalogMGCPGatewayEndpointModEVT Deletes an Endpoint Module for the Analog MGCP Gateway.	
<pre>conf t voice-port {{ pwf.PORT_NUM }} no timeouts call-disconnect default cptone default timing hookflash-in default description no signal default ring frequency shutdown exit no dial-peer voice {{ pwf.DIAL_PEER_NO }} pots end</pre>	<p>pwf.PORT_NUM - This is the FXS port number of the analog gateway device.</p> <p>pwf.DIAL_PEER_NO - returns the dial peer number we use to generate dial peer. It starts from 4 for the first dial peer, and increase by 1 for the next one.</p>

Default IOS Commands	Available Variables
HcsUpdateAnalogGatewayEVT Updates the Analog MGCP Gateway.	
<pre>conf t hostname {{pwf.GatewayDAT.domainName}} no mgcp bind control source-int {{ pwf. ↪previousGatewayDAT.networkInterface }} mgcp bind control source-int {{ pwf.GatewayDAT. ↪networkInterface }} no mgcp bind media source-int {{ pwf. ↪previousGatewayDAT.networkInterface }} mgcp bind media source-int {{ pwf.GatewayDAT. ↪networkInterface }} end</pre>	<p>pwf.GatewayDAT.networkInterface - This is the physical device network interface (Ethernet Port) for the analog gateway.</p>

Default IOS Commands	Available Variables
HcsUpdateAnalogGatewayEndpointEVT Updates the Endpoint for the Analog MGCP Gateway.	
<pre> conf t voice-port {{ pwf.PORT_NUM }} no signal signal {{macro.HcsIosCmdAnalogGwSignalMCR}} no timeouts call-disconnect timeouts call-disconnect {{ fn.as_string pwf. GatewayDAT.disconnectTimeout }} no cptone cptone {{ pwf.GatewayDAT.cpTone }} no shutdown end </pre>	<p>pwf.PORT_NUM - This is the FXS port number of the analog gateway device.</p> <p>pwf.GatewayDAT.disconnectTimeout - Time in seconds for which a connection is maintained after the completion of a communication exchange.</p> <p>pwf.GatewayDAT.cpTone - This is the call progress tone of the country that supports each analog device in the gateway.</p>

8.13.6. Translation Rule Numbering

The following information can be helpful to decode the number of Translation Rules included in IOS Command Builders.

- The first digit indicates if the rule is for SRST, VoIP, or TDM: 7 for SRST, 8 for VoIP, and 9 for PSTN.
- The second digit indicates if it is for incoming or outgoing call: 1 for incoming and 0 for outgoing
- The third digit indicates if it is for calling or called number: 1 for calling and 2 for called
- The fourth digit indicates if NOA is used: 1 is for NOA and 2 for no NOA and defines on the TDM trunk to the PSTN.

Examples:

- Translation-rule 9011 - for handling calling number of an outgoing call to the PSTN where NOA is used.
- Translation-rule 9022 - for handling called number of an outgoing call to the PSTN where NOA is not used.
- Translation-rule 9111 - for handling calling number of an incoming call from the PSTN where NOA is used.

8.13.7. Set up a Command Builder

This procedure sets up a Command Builder that contains an IOS Commands template for an event.

Note: One event can trigger multiple Command Builders.

Perform these steps:

1. Log in as provider, reseller, or customer administrator.
2. Set the hierarchy path to the level where you want to define your Command Builder.
3. Choose **Apps Management > IOS > Command Builder**.

4. Click **Add**.
5. Provide the following information:

Field	Description
Name	Enter a unique name for the builder. This field is mandatory.
Event Name	Select the event that triggers the builder. This field is mandatory
Description	Enter a description for the builder.
Command Template	Enter the IOS Commands template for the event, one command per line. You can use macros in the IOS Commands template for variable substitution.
Enabled	Clear the Enabled check box to create a builder but not have it available to run.
Applicable Device Type	Select the device type that the commands can run on. This field is mandatory.

6. Click **Save**.

8.13.8. Clone a Command Builder

Use this procedure to clone a Command Builder that contains an IOS Commands template for an event. For instance, use this procedure to modify one of the default Command Builders to suit your needs.

Note: One event can trigger multiple Command Builders.

Perform these steps:

1. Log in as provider, reseller, or customer administrator.
2. Set the hierarchy path to the level where you want to clone an existing Command Builder.
3. Choose **Apps Management > IOS > Command Builder**.
4. Click the Command Builder name you want to clone.
5. Choose **Action > Clone**.
6. Modify the following information as needed:

Field	Description
Name	Enter a unique name for the builder. This field is mandatory.
Event Name	Select the event that triggers the builder. This field is mandatory
Description	Enter a description for the builder.
Command Template	Enter the IOS Commands template for the event, one command per line. You can use macros in the IOS Commands template for variable substitution.
Enabled	Clear the Enabled check box to create a builder but not have it available to run.
Applicable Device Type	Select the device type that the commands can run on. This field is mandatory.

7. Click **Save**.

8.13.9. Set up an IOS Device

Perform these steps:

1. Log in as provider, reseller, or customer administrator.
2. Set the hierarchy path to the customer hierarchy node where you want to set up the IOS Device.
3. Choose **Device Management > IOS > IOS Devices**.
4. Click **Add**.
5. Provide the following information:

Field	Description
IOS Device Name	Enter the name for the IOS Device. This field is mandatory.
Description	Enter a description for the IOS Device.
Prime Collaboration	Select the Prime Collaboration to manage the IOS Device.

6. In the **Network Addresses** pane, configure the SERVICE_PROVIDER_SPACE address space.

Field	Description
Address Space	Address Space Type. SERVICE_PROVIDER_SPACE is the default. This field is required.
IPV4 Address	Enter the IP address of the IOS Device.
Host Name	The Host Name field is automatically populated with the IOS Device Name. If the IOS Device Name is not the host name, you can edit this field to provide the host name, or provide an IP address in the IPV4 Address field. Note: Either a host name or an IP address is required. If both are provided, the host name is used. If a host name is provided must be resolvable by the IOS Device.
Domain	The domain of the IOS Device.
Description	An optional description for the network address

If NAT is used, also configure an APPLICATION_SPACE network address.

If a double NAT is deployed, also configure a CUSTOMER_SPACE network address.

7. Optionally, expand **Credentials**.
 - a. Add credentials for CLI, SNMP_V2, SNMP_V3 credentials types. Click + to add more credentials.
 - b. For CLI and SNMP_V3, fill in the user ID and password that you configured when you installed the IOS Device. For SNMP_V2, only the password is required.
 - c. For SNMP credentials, choose RO (Read-only) or RW (Read or Write) for the Access Type. The default is RO.
 - d. Provide an optional description for the credential.

SNMP credentials are used by PCA to manage the IOS Device. CLI credentials are used to log in to the IOS Device.

Note:

SNMP configuration must be done manually on the IOS Device.

8. Click **Save**.

8.13.10. Analog Gateways

A Cisco analog gateway connects fax machines, analog phones, and modems in the SCCP/MGCP protocol. Any IOS device that has FXS ports configured as SCCP/MGCP endpoints on Cisco Unified Communications Manager is considered an SCCP/MGCP analog gateway.

An analog device contains analog phones, which are endpoints in Cisco Unified Communications Manager.

8.13.11. Set up an Analog Gateway

Before You Begin

Add an IOS device in VOSS-4-UC at the Customer level hierarchy. To add an IOS device, see [Set up an IOS Device](#).

Note: VOSS-4-UC supports SCCP and MGCP protocols. It does not support BRI endpoints. Do not add slots or modules or subunits for BRI.

Procedure

1. Log in as provider, reseller, or customer administrator.
2. Choose **Device Management > IOS > Analog Gateways**.
3. Click **Add**.
4. Choose the required hierarchy path from the drop-down and click **OK**.
5. On the **Gateway** tab, complete, at minimum, the mandatory **Gateway** fields (see below).
6. On the **Gateway Units** tab, click + to expand **Modules**, and complete, at minimum, the mandatory **Gateway Units - Modules** fields (see below).
7. On the **Endpoints** tab, click + to expand the **SCCP** or **MGSP** endpoints, and complete, at minimum, the mandatory:
 - SCCP Endpoints Fields (see below)
 - MGCP Endpoints Fields (see below)
8. On the **Config** tab, click + to expand the **Product Specific Configuration Layout**, and complete the required Config: Product Specific Configuration Layout Fields (see below).
9. Click **Save**.

There are few scenarios that show the expected behaviour of an Analog gateway when adding, deleting, or modifying a gateway.

Successful Scenario	Failure Scenario
Adding an Analog device with a phone line.	Removing the phone line from the endpoint.
Adding an Analog gateway without using enable command builder.	Adding a phone line after adding the command builder.
Removing the command builder after adding an analog gateway with command builder.	Adding an analog gateway without a phone line after adding a phone line to an endpoint. Note: Ensure to add the Directory Names to both endpoints.

Gateway Fields

Field	Description
IOS Device *	Choose the required IOS Device from the drop-down list. For example: IOS 11. This is a mandatory field. Note: The IOS device identifies the devices that are not associated with any Analog Gateways.
Product *	Choose the product from the drop-down list. For example: VG202, where VG represents Voice Gateway and 202 represents port. It has 2 ports, 0 and 1. This is a mandatory field. Note: The analog gateway supports Following models: <ul style="list-style-type: none"> • VG202: 2 ports • VG204: 4 ports • VG224: 24 ports • VG310: 24 ports • VG320: 48 ports • VG350: 144/160 ports • VG400: 8 ports max • VG450: 144 ports max
Protocol *	Choose the protocol from the drop-down list. The available protocols are SCCP and MGCP . This is a mandatory field.
Gateway Name *	Enter the MAC address of the analog gateway. For example: SKIGW0102030405, where SKI represents SCCP, GW represents gateway, and the last 10 digits represents the MAC address of the gateway. This is a mandatory field for the SCCP protocol.
Domain Name	Enter a fully qualified domain name. For example: E7C1VG310.hcsent17.com. This is a mandatory field for the MGCP protocol.
Call Manager Group *	Choose the call manager group from the drop-down list. For example: Default. This is a mandatory field. Note: Call Manager Group is default based on the site default device pool.
Enable Command Builder	Leave the check box cleared to generate IOS commands, when Analog Gateway is added, deleted, or modified.

Note: For more information, see [Local Break Out and Analog Gateway Events, IOS Commands, and](#)

Variables. To view generated commands from Command Builder, see [View IOS Commands Log](#).

Field	Description
Gateway Network Interface *	Enter a Gateway Network Interface. For example: FastEthernet0/0, FastEthernet0/1 or GigabitEthernet0/0, GigabitEthernet0/1. This is a mandatory field. Note: Check the network interface at the Physical Device, then choose the appropriate Network Interface and Port as applicable. The Network Interface is used in Command Generation. Choose FastEthernet for all 2x series and GigabitEthernet for all 3x series.
Call Disconnect Timeout *	Enter the time unit for Call Disconnect Timeout. For example: 2. This is a mandatory field. Note: The time unit always is in seconds. Do not enter any negative timer values.
CP Tone *	Choose the call progress tone (country code) from the drop-down list. For example: in (for India). This is a mandatory field. Note: CP Tone is an FXS configuration parameter that supports each analog device in the gateway.
Signal *	Choose a signal from the drop-down list. For example: loop-start or ground-start. This is a mandatory field. Note: Signal is an FXS configuration parameter that supports each analog device in the gateway.

Gateway Units - Modules Fields

Field	Description
Slot *	<p>Choose the required value from the drop-down list. For example: 0. This is a mandatory field</p> <p>Note:</p> <ul style="list-style-type: none"> • Add only those Units (Modules) and Subunits that are listed in the drop-down list, without duplicate the units and subunit numbers. • If duplicating entry is made for a slot, then the new slot overwrites the older configuration. You may lose previously configured endpoints. • For VG310 model, do not choose any module for slot 1.
Module *	<p>Choose the available module from the drop-down list. For example: NM-4VWIC-MBRD.</p> <p>Note:</p> <p>Only modules that are available for the slot appear in the list.</p>
Subunits *	Click + to expand Subunits . This is a mandatory field.
Subunit Position *	<p>Choose the subunit position from the drop-down list. For example: 0.</p> <p>Note:</p> <p>Subunit position 1 on the VG310 gateway has no available hardware by design, so choosing a value of 1 in this drop-down will not allow you to continue. Please choose a different subunit position to continue setting up your gateway.</p>
Subunit *	Choose the subunit from the drop-down list. For example: VIC3-2FXS-E/DID-SCCP.

Note: When managing Gateways Units for Analog Gateways on the on the Legacy Admin GUI, the Slot number and Subunit Position may disappear from the form, but values are captured.

SCCP Endpoints Fields

Option	Description
Gateway Name	This read-only field is populated from the analog gateway for the SCCP protocol. This is a mandatory field.
Slot *	This read-only field is populated from the gateway units. This is a mandatory field.
Subunit Position *	This read-only field is populated from the gateway units. This is a mandatory field.
Port Number *	This read-only field is populated from the gateway units. This is a mandatory field.
Product Type *	Choose the product type from the drop-down list. For example: Analog Phone. This is a mandatory field.
Device Protocol *	Choose the device protocol from the drop-down list. This is a mandatory field.
Device Name *	This read-only field is populated from the analog gateway. This is a mandatory field.
Description	When the endpoint is added, the default description is in the format: <i>Endpoint for slot/subunit/port n/n/n gateway @domain</i> that can be updated if required. This is an optional field and accepts a string value.
Device Pool *	Choose the device pool from the drop-down list. For example: Cu2Si2-DevicePool. This is a mandatory field.
Phone Button Template *	Choose the phone button template from the drop-down list. For example: Standard Analog. This has a specific phone button template for the analog gateway. This is a mandatory field.
Common Phone Profile *	Choose the common phone profile from the drop-down list. For example: Standard Common Phone Profile. It includes the attributes (services or features) that are associated with a particular user. This is a mandatory field.
Calling Search Space	From the drop-down list, choose the appropriate calling search space. The calling search space specifies a collection of partitions that are searched to determine how a collected (originating) number should be routed.
AAR Calling Search Space	Choose the appropriate calling search space for the device to use when it performs automated alternate routing (AAR). The AAR calling search space specifies the collection of route partitions that are searched to determine how to route a collected (originating) number that is otherwise blocked due to insufficient bandwidth.
Media Resource Group List	This list provides a prioritized grouping of media resource groups. An application chooses the required media resource, such as a Music On Hold server, from among the available media resources according to the priority order that a Media Resource Group List defines.
Location *	Choose a location from the drop-down list. For example: Cu2Si2-Location. This is a mandatory field.
AAR Group	Specify the automated alternate routing (AAR) group for this device. The AAR group provides the prefix digits that are used to route calls that are otherwise blocked due to insufficient bandwidth.
Owner	Choose from the drop-down list.

Option	Description
Always Use Prime Line for Voice Message	Choose the required options from the drop-down list. For example: On, Off or Default. This is a mandatory field. This specifies whether the device will always use the prime line for voice messages.
Geolocation	From the drop-down list, choose a geolocation. You can choose the Unspecified geolocation, which designates that this device does not associate with a geolocation.
Transmit UTF-8 for Calling Party Name	Keep the check box clear.
Called Party Transformation CSS	<p>This setting allows you to send transformed called party number in SETUP message for outgoing calls. Make sure that the Called Party Transformation CSS that you choose contains the called party transformation pattern that you want to assign to this device.</p> <p>Note: If the Called Party Transformation CSS is configured as <None>, the transformation does not match and does not get applied. Ensure that you configure the Called Party Transformation CSS in a non-null partition that is not used for routing.</p>
Use Device Pool Called Party Transformation CSS	Select the check box.
Allow Control Of Device From CTI	Select the check box.
Logged Into Hunt Group	Select the check box.
Calling Party Transformation CSS (Caller ID For Calls From This Phone)	<p>This setting allows you to send transformed calling party number in SETUP message for outgoing calls. Also when redirection occurs for outbound calls, this CSS will be used to transform the connected number sent from Cisco Unified Communications Manager side in outgoing NOTIFY messages. Make sure that the Calling Party Transformation CSS that you choose contains the calling party transformation pattern that you want to assign to this device.</p> <p>Note: If the Calling Party Transformation CSS is configured as <None>, the transformation does not match and does not get applied. Ensure that you configure the Calling Party Transformation Pattern in a non-null partition that is not used for routing.</p>
Use Device Pool Calling Party Transformation CSS (Caller ID for Calls From This Phone)	Select the check box.
Calling Party Transformation CSS (Device Mobility Related Information)	

Field	Description
Use Device Pool Calling Party Transformation CSS (Device Mobility Related Information)	Select the check box.
BLF Presence Group *	Choose the presence group for busy lamp field buttons from the drop-down list. For example: Standard Presence group is the default value. This is a mandatory field.
Device Security Profile *	Choose options from the drop-down list. For example: Analog Phone - Standard SCCP Non-Secure Profile. This is mandatory field.
MLPP Domain	If you leave the value <None>, this device inherits its MLPP domain from the value that was set for the device pool of this device. If the device pool does not have an MLPP Domain setting, this device inherits its MLPP domain from the value that was set for the MLPP Domain Identifier enterprise parameter.
MLPP Indication	Choose options from the drop-down list. For example: On, Off, or Default. This is a mandatory field.
MLPP Preemption	Choose options from the drop-down list. For example: Disabled, Forceful, Default. This is a mandatory field. Note: If there are any changes to be performed to analog phone line then do not refer line settings. For example: Changing CSS is done under Subscriber Management.
Line	Click + to expand Line .
Pattern *	Choose the route pattern from the drop-down list. For example: 08231006
Enduser	Click + to expand Enduser .
User ID	Choose the available user ID from the drop-down list. For example: Subscriber 1
Product Specific Configuration Layout	Click + to expand Product Specific Configuration Layout .
Key	Enter the Key for the product specific configuration layout. For example: stcapRegCap.
Value	Enter the Key for the product specific configuration layout. For example: 0.

Note: For more optional field information, see [Configure Phones](#).

MGCP Endpoints Fields

You can configure multiple endpoints for an MGCP gateway.

Option	Description
Domain Name	This read-only field is populated from the analog gateway for the MGCP protocol. This is a mandatory field.
Slot *	This read-only field is populated from the gateway units. This is a mandatory field.
Subunit Position *	This read-only field is populated from the gateway units. This is a mandatory field.
Port Number *	This read-only field is populated from the gateway units. This is a mandatory field.
Product Type *	Choose the product type from the drop- down list. For example: Analog Phone. This is a mandatory field.
Device Protocol *	Choose the device protocol from the drop-down list. For example: SCCP. This is a mandatory field.
Protocol Side *	This is a read-only field except when creating a device. This is a mandatory field.
Class *	This is a read-only field except when creating a device. This is a mandatory field.
Device Name *	This read-only field is populated from the analog gateway. This is a mandatory field.
Description	When the endpoint is added, the default description is in the format: <i>Endpoint for slot/subunit/port n/n/n gateway @domain</i> . Update it with an optional description for the device. This is an optional field and accepts a string value.
Device Pool	Choose the device pool from the drop-down list. For example: Cu2Si2-DevicePool. This is a mandatory field.
Calling Search Space	Choose the space name from the drop-down list. This is an optional field.
Common Device Configuration	Specify the Configuration name of the device. This is an optional field.
Network Locale	Choose the location from the drop-down list. This is an optional field.
Location *	Choose a location from the drop-down list. For example: Cu2Si2-Location. This is a mandatory field.
Media Resource Group List	Choose a media resource to allocate for a device. This is an optional field.
AAR calling search space	Choose the appropriate calling search space for the device to use when it performs automated alternate routing (AAR) from the drop-down list. This is an optional field.

Field	Description
Use Trusted Relay Point	Choose one of the following values: <ul style="list-style-type: none"> • Off - Choose this value to disable the use of a Trusted Relay Point (TRP) with this device. This setting overrides the Use Trusted Relay Point setting in the common device configuration with which this device associates. • On - Choose this value to enable the use of a TRP with this device. This setting overrides the Use Trusted Relay Point setting in the common device configuration with which this device associates. • Default - If you choose this value, the device uses the Use Trusted Relay Point setting from the common device configuration with which this device associates.
AAR Group	Specify the automated alternate routing (AAR) group for this device. The AAR group provides the prefix digits that are used to route calls that are otherwise blocked due to insufficient bandwidth.
Geolocation	Specify the location name. This is an optional field.
Transmit UTF-8 for Calling Party Name MLPP Preemption	Keep the check box cleared.
Port Number *	Configure the ports for the MGCP Endpoint . This is a mandatory field.
Trunk *	This field value auto-populates depending on the value set for the Port Number. This is a mandatory field.
Trunk Direction *	The field value auto-populates depending on the value set for the Number. This is a mandatory field.
Trunk Level *	The field value auto-populates depending on the value set for the Number. This is a mandatory field.
Attendant DN	Specify this field for group start and loop start. This is a mandatory field.
Prefix DN	Enter the prefix digits that are appended to the digits that this trunk receives on incoming calls.
Num Digits *	Enter the number of significant digits to collect between 0 to 32.
Expected Digits *	Enter the number of digits that are expected on the inbound side of the trunk. You can leave zero as the default value, if you are unsure.

Field	Description
SMDI Port Number (0 - 4096) *	Enter the first SMDI port number of the T1 span. If you set this parameter to a non-zero value and this gateway belongs to an unknown type of route list, route group, or route list, hunting does not continue beyond this span.
Unattended Port	Select this check box to indicate an unattended port on this device.
Line	Click + to expand Line .
Label	Use this field only if you do not want the directory number to show on the line appearance. Enter text that identifies this directory number for a line and phone combination.
E164 Mask	Indicate a phone number (or mask) that is used to send Caller ID information when a call is placed from the line. You can enter a maximum of 24 numbers, the international escape character + and 'X' characters. The Xs represent the directory number and must appear at the end of the pattern. For example, if you specify a mask of 972813XXXX, an external call from extension 1234 displays a caller ID number of 9728131234.
Dirn, Pattern *	Choose the route pattern from the drop-down list. For example: 08231006.
Dirn, Route Partition	Choose the partition to which the directory number belongs. Make sure that the directory number that you enter in the Directory Number field is unique within the partition that you choose. If you do not want to restrict access to the directory number, choose <None> for the partition.
Enduser	Click + to expand Enduser .
User ID	Choose the available user ID from drop-down list. For example: Subscriber 1.
Index	This field is the line position on the device. If left blank, an integer is automatically assigned.
Trunk Selection Order *	Choose the order from the drop-down list to display the call routing logic for the route pattern.

Config: Product Specific Configuration Layout Fields

Field	Description
Key	Enter the Key for the product-specific configuration Layout. For example stcap-pRegCap.
Value	Enter the Key for the product-specific configuration layout. For example: 0.

8.13.12. Add Port to Analog Gateway

A new port can be added to a gateway located at site level without prior knowledge of existing ports.

This is particularly useful on the higher density gateways and in cases where a port is bulk loaded.

VG2XX and VG3XX models (FXS ports) are supported providing a range of port capacities from 2 – 160 ports. VG400 (8 ports max) and VG450 (144 ports max) models (FXS ports) are also supported.

This is done using the **Add port to Analog Gateway** form (default menu **Device Management > IOS > Add port to Analog Gateway**).

VOSS-4-UC checks for the first free port space on the gateway, and subsequently adds the port to the gateway.

Upon completion of the transaction, a log entry will show the port number added.

When selecting a Directory Number (DN) to add to a new port:

- The next available Directory Number from site level INI is pre-populated.
- The **Directory Number** drop-down can be used to select alternative Directory Numbers.
- If a bulk loader or form drop-down does not have the Directory Number field populated, the next number from site level INI is used. If this is not available, the next available number from customer level INI is used.

8.13.13. IOS Gateway Manual Configuration

This procedure adds a PRI Trunk to connect to the PSTN.

VOSS-4-UC does not generate any controller, interface, or dial peer commands for the gateway. This has to be manually added after the command builder has generated the gateway configuration.

Perform these steps:

1. Configure PRI on a channelized E1 or T1 controller with the following commands:

- a. controller <T1 or E1><slot/port>
where slot/port is the controller location in the gateway
- b. framing <esf | sf or crc4 | non crc4>
esf/sf for T1 and crc4/non crc4 for E1
- c. linecode <b8zs | ami or bdb3 | ami>
b8zs/ami for T1 and hdb3/ami for E1
- d. clock source <internal/line>
- e. pri-group timeslots <1-24 | 1-31>
Use all channel on the trunk 1-24 for T1 and 1-31 for E1

2. Configure Serial Interface with the following commands:

- a. interface serial <slot/port>:<23 | 15>
slot/port similar to the above for controller and use 23 for T1 and 15 for E1
- b. no ip address
- c. encapsulation hdlc
- d. isdn protocol-emulate <network | user>
- e. isdn switch-type <switch-type>
See IOS documentation for supported switch types.
- f. isdn incoming-voice voice
- g. isdn bchan-number-order <ascending | descending>
- h. no cdp enable

3. Configure POTS dial peer with the following commands:

- a. dial-peer voice 95 pots
- b. translation-profile incoming <91XX>

For incoming call:

- use 9111 when both called and calling number have NOA
- use 9121 when called number does not have NOA but Calling number has NOA
- use 9112 when calling number does not have NOA but Called number has NOA
- use 9122 when both called and calling number do not have NOA

- c. translation-profile outgoing <90XX>

For outgoing call:

- use 9111 when both called and calling number have NOA
- use 9121 when called number does not have NOA but Calling number has NOA
- use 9112 when calling number does not have NOA but Called number has NOA
- use 9122 when both called and calling number do not have NOA

- d. destination-pattern 90[1-9]T

- e. incoming called-number .

- f. no digit-strip

- g. direct-inward-dial

- h. port <slot/port>:<23 | 15>

Similar to what is configured for serial interface

- i. no register e164

Example IOS gateway manual configuration

```

controller T1 0/0/0
framing esf
linecode b8zs
clock source line
pri-group timeslots 1-24

interface serial 0/0/0:23
no ip address
encapsulation hdlc
isdn protocol-emulate user
isdn switch-type primary-net5
isdn incoming-voice voice
isdn bchan-number-order descending
no cdp enable

dial-peer voice 95 pots
translation-profile incoming 9111
translation-profile outgoing 9011
destination-pattern 90[1-9]T
incoming called-number .
no digit-strip

```

(continues on next page)

(continued from previous page)

```
direct-inward-dial
port 0/0/0:23
no register e164
```

8.13.14. View IOS Commands Log

Using the IOS Commands log, an administrator can see a list of command sets that were triggered by different events. An administrator can copy the IOS Commands template and paste it into the IOS device CLI to be executed.

By default, the command sets are listed with the most recent at the top.

Note: Deleting a hierarchy node, such as a site, deletes all IOS Command Builders and associated IOS Commands templates configured at the hierarchy node.

Perform these steps:

1. Log in as provider, reseller, or customer administrator.
2. Set the hierarchy path to the level for which you want to view IOS Commands.
3. Choose **Apps Management > IOS > Commands**. A table containing the Command Builders that have been triggered is displayed. The table contains this information:

Column	Description
Timestamp	The time of the event that triggered the Command Builder.
Device Name	The IOS device associated with the event that fired the Command Builder.
Gateway Name	The SIP Local Gateway or Analog Gateway associated with the event that fired the Command Builder.
Command Builder	The name of the Command Builder that was triggered. To view the IOS Commands template associated with a Command Builder, click the Command Builder name. The Command Builder configuration is displayed, including the IOS Commands template.
Description	The description of the Command Builder that was triggered.
Device Deleted	Select this check box if the associated device has been deleted.
Hierarchy	The hierarchy level of the event that triggered the Command Builder.

8.13.15. Consolidate IOS Commands

To copy IOS commands to an IOS device CLI that is generated by multiple events, follow these steps:

Procedure

1. Log in as provider, reseller, or customer administrator.
2. Set the hierarchy path to the customer or site for which you want to consolidate IOS commands.
3. Choose **Apps Management > IOS > Consolidate Commands**.

4. Click **Add**.
5. On the **Consolidate Commands** screen, complete at minimum, the mandatory *Consolidate Commands Fields*.
6. Click the required command templates listed in the **Available** list, and click **Select** to move them to the **Selected** list.

Click **Remove** to unselect a command template.

Note:

You can change the order of the command templates by clicking **Move Up** and **Move Down**. However, the consolidated commands are generated in chronological order regardless of the order of the selected command templates.

7. Click **Save**.

The new command consolidation instance appears in the list.

8. Click the command consolidation instance you created.

In the Command Template field, all the commands from the command templates you selected appear in one window. Comments are used to separate and identify the source command templates. You can edit the consolidated commands.

Any modifications to the Command consolidation, displays the entire list of commands in a single instance. The commands present earlier to the modification cannot be viewed separately as the commands from the earlier events are treated as a single instance.

What to Do Next

After you have consolidated the IOS commands you want, copy them from the Commands Template field to the IOS device CLI.

Consolidate Commands Fields

Field	Description
Name *	Enter a unique name for the command consolidation. This field is mandatory.
Description	Enter an optional description for the command consolidation.
IOS Device *	Choose the IOS device from which you want to consolidate commands.
Device Type *	<p>Choose the device types for which you want to consolidate commands.</p> <p>IOS Device Choose this to get commands for the IOS device and any SIP Local Gateway or Analog Gateway hosted on that device.</p> <p>SIP Local Gateway Choose this to get commands only for the SIP Local Gateway.</p> <p>Analog Gateway Choose this to get commands only for the Analog Gateway. You do not get commands for devices that have been deleted.</p> <p>Note: If you select site hierarchy, only specific commands such as IOS Device or SIP Local gateway are displayed. To view both the IOS and Analog gateway commands, choose the customer hierarchy path.</p>

8.13.16. Regenerate IOS Commands

This procedure regenerates IOS commands for events that occurred for the selected device, and removes all old IOS commands for the selected device.

Because the variables that are used in generating IOS commands may change, you may want to regenerate IOS commands with the latest configuration. IOS commands can be regenerated for the following devices:

- IOS Device
- SIP Local gateway
- Analog Gateway

Regenerating commands for an IOS Device also regenerates commands for any SIP Local gateway or Analog Gateway hosted on the IOS Device.

Perform these steps:

1. Log in as provider, reseller, or customer administrator.
2. Choose one of the following depending on the device for which you want to regenerate IOS commands:
 - **Apps Management > IOS > IOS Devices** for an IOS Device and any gateways it hosts.
 - **Apps Management > IOS > SIP Local Gateways** for a SIP Local Gateway.
 - **Apps Management > IOS > Analog Gateways** for an Analog Gateway.
3. Click the device for which you want to regenerate commands.
4. Choose **Action > Regenerate IOS Commands**.

IOS commands for the events that had occurred for the selected device are regenerated. All old IOS commands for the selected device are removed.

Next Steps

- View the regenerated commands in the IOS Commands log. See [View IOS Commands Log](#).

8.14. UC Prep Management

8.14.1. Introduction

The UCPrep Profile tool further streamlines the preparation process of deployment of Cisco applications with VOSS-4-UC Provider and Enterprise so that administrators will not have to repeat the same configuration tasks over and over every time they stage or build a UC Application.

The tool provides an easy, flexible and repeatable way to define, store and load static configurations and other infrastructure setup needed in the UC applications. One or multiple sets of static configuration data can be set up and stored. The UCPREP Profile tool use can vary from provider to provider and even by customer within a provider.

The created static configuration can then be pushed to UC Apps as a “one-off”, and does not always have to be tied into a overall workflow.

UCPrep Feature Scope

The UCPrep tool covers the following areas of the Cisco Application Deployment:

- CUCM Date Time Groups
- CUCM Groups
- CUCM Host Adjustment
- CUCM SIP Trunk Security Profiles
- CUCM SIP Profiles
- CUCM Audio Codec Preferences
- CUCM Application Users
- CUCM Feature Control Policies
- CUCM Route Filters
- CUC Authentication Policies
- CUC User Templates

It is not necessary to adjust all of these UC Application elements within a given UCPrep Profile. For example, if a Unity server is not part of a deployment, the CUC elements may remain un-configured. Similarly, if there is no need to adjust the hostname of a CUCM node, then the input form tab for that configuration can remain empty.

8.14.2. Caveats

- The push of data needs to be run at the level of the apps.
- None of the work has been done to apply required fields from the perspective of UC Apps to the data model.

8.14.3. Menu Descriptions

When the feature is exposed on an administrator menu, a list of menu items are available to carry out the UCPrep tasks.

A typical workflow would be that one or more UCPrep Profiles are set up for use and then pushed to UC Applications.

- Initial Timezones can be selected before the UCPrep Profile configuration in order to simplify the management of the drop-down list of timezones in the tool.
- The UCPrep Application User List can also be set up where these are repeatedly used and pushed to UC Applications.
- The related Configuration Templates that drive the workflows of the configuration of the elements are grouped together for detailed customization and management.

Menu Name	Description and Notes
UCPrep Profile Push	This is the menu element used to push profile data into the target Cisco UC Applications.
UCPrep Profiles	The VOSS data structure that contains the configurations that can be repeatedly applied to UC Applications.
UCPrep Friendly Time-zones	List of time zones that is a mirror of the Call Manager available time zone database. This table is used to populate the Date/Time Group portion of the UCPrep Profile.
UCPrep Application User List	Administrator configurable list of Application Users that may be pushed into a Cisco Call Manager.
UCPrep Configuration Templates	The collection of configuration templates that are utilized to provision the individual UC Application elements. Note that the menu item filters the configuration templates based on the prefix "ucprep". Should any configuration template be cloned for customization please use the prefix.

8.14.4. UCPrep Profiles

UCPrep Profiles [Standard UC Deployment USA] Save Delete Help Back Action ▾

UCPrep Profile **CUCM Date Time Groups** **CUCM Group** **CUCM Host Adjustment** **CUCM SIP Trunk Security Profiles** **CUCM SIP Profile** **More ▾**

UC Prep Profile Name	Standard UC Deployment USA
UC Prep Profile Notes	Standard set of UC deployment for USA Country-wide. Date Time Groups: NY, Chicago, Denver, Phoenix, Los Angeles. CUCM Groups - PubOnly. CUC User Templates - Standard, Advanced.

From the **UCPrep Profiles** menu, the list view shows all created profiles at the administrator's hierarchy and below.

UCPrep Profiles are intended to be templates at a higher level in the hierarchy and are then cloned to a lower level for specific settings to a cluster. When cloning a UCPrep Profile the UC Prep Profile Name must be unique. The **UCPrep Profile Notes** should also be descriptive so that this information is available when the UCPrep Profile Push tool is used.

For example, a provider level profile may contain global element configuration that are not site or cluster specific. At a customer or site level, this profile can then be cloned and updated with configuration elements that apply to the customer or site.

UCPrep Profiles Reference

Name	Field Description
UC Prep Profile Name	The friendly name for the UCPrep Profile. This is the name populated into the push tooling above.
UC Prep Profile Notes	A field available to enter helpful information describing the UCPrep Profile. This is the field populated to the push tooling above.

8.14.5. UCPrep Profile Push

UCPrep Profile Push

UC Prep Profile:	Standard UC Deployment USA
Profile Description	Standard set of UC deployment for USA Country-wide. Date Time Groups: NY, Chicago, Denver, Phoenix, Los Angeles. CUCM Groups - PubOnly. CUC User Templates - Standard, Advanced.
Target Call Manager	["10.5.31.21", "8443"]
Target Unity	["10.5.31.22", "443"]

UCPrep Profile Push Reference

Name	Field Description
UCPrep Profile	Drop-down providing the available UCPrep Profiles configured on the system.
Profile Description	Description populated automatically when a UCPrep Profile is chosen from the UC Prep Profile drop-down.
Target Call Manager	Cisco Call Manager to which the UCPrep Profile Data will be pushed.
Target Unity	Cisco Unity server to which the UCPrep Profile Data will be pushed.

8.14.6. Date Time Groups

- Configuration Templates can be customized and added so that these become available in the **Date/Time Group Configuration Template** drop down list, for example to templates to customize the date format and listed in the **UCPrep Configuration Templates** menu.
- The **UCPrep Friendly Timezones** menu can be used to manage the list available in the **timezones** drop-downs, for example to shorten the list to only include the timezones that are used in the Data/Time groups.

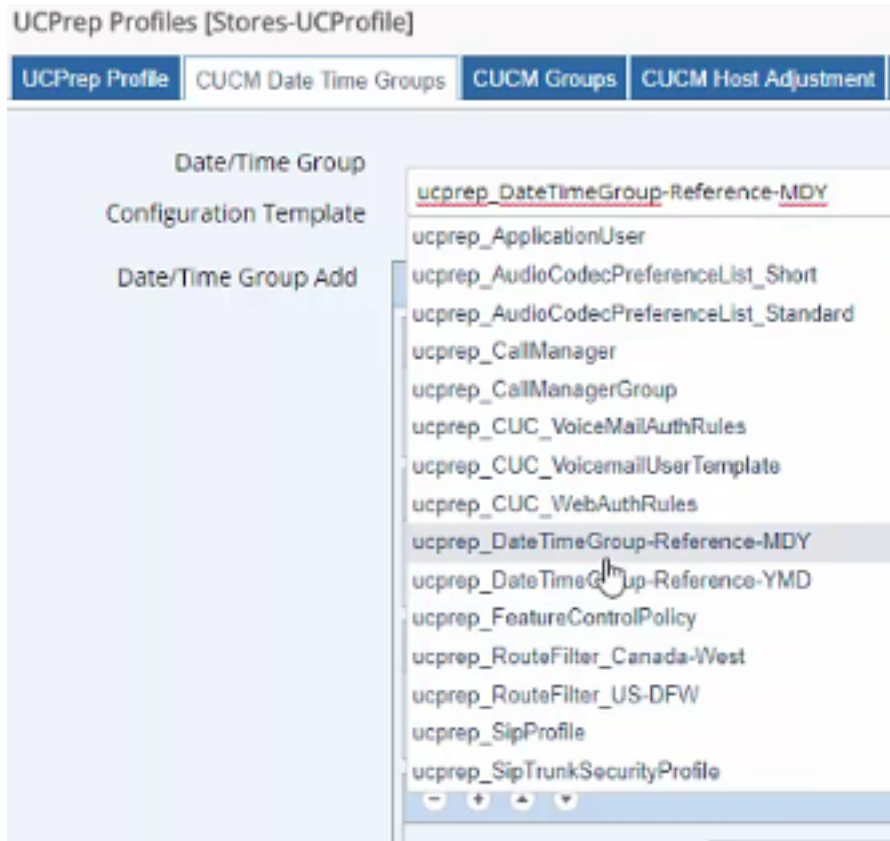

Date Time Groups Reference

Field	Field Description
Date/Time Group Configuration Template	Configuration template used to configure the specific settings to a Data-Time Group in Call Manager. Options available in the Configuration template are date format, separator, Time format, and so on. Note: the name of the date time group is automatically configured based on the chosen timezone entry. A timezone drop-down entry of <i>America/New_York</i> will create a date time group named <i>America-New_York</i> .
Date/Time Group Add	Timezones are chosen and added via drop-down. Any number of timezones may be chosen.

8.14.7. Call Manager Groups

In order for the Member drop-downs to function, a UCPrep Profile must be cloned to the level of the UC Applications.

Note that in this example, the UCPrep Profile that is built is entered at the “Axis” customer application level.

The screenshot displays the 'UCPrep Profiles [Standard UC Deployment USA - AXIS]' interface. The 'CUCM Group' tab is active, showing two 'Standard CUCM Group' entries. Each entry has a 'Call Manager Group Name' field and a 'Members (In Order)' list. The first group, 'Sub1Sub2', lists 'CM_3121CUCMSub1' as the first member and 'CM_3121CUCMSub2' as the second. The second group, 'Sub2Sub1', lists 'CM_3121CUCMSub2' as the first member and 'CM_3121CUCMSub1' as the second. The interface includes a search bar, navigation tabs, and a 'Standard CUCM Group' container.

The order in which the members are added indicate primary and secondary members of the group.

Call Manager Groups Reference

Name	Description
Standard CUCM Group	Entry mechanism to allow for configuration of an unlimited number of Call Manager Groups.
Call Manager Group Name	Free text entry box for Call Manager Group Name.
Members (In Order)	Add Call Manager nodes via drop-down by adding member entry boxes. The Call Manager nodes are added to the Call Manager Groups in the order presented in the input box.

8.14.8. Call Manager Host Adjustment

Multiple nodes of the cluster at the hierarchy can be modified.

Considerations for Host Adjustment are:

- Since the CUCM Host Adjustment modifies existing data in Call Manager, the data must be re-set or removed if a UCPrep Profile must be applied more than once.
- The CUCM Host adjustment occurs after the Call Manager Group configuration because the Call Manager will internally adjust the node names within a Call Manager Group when the node is renamed.
- If a node name is adjusted and a UCPrep profile is run a second or more times, the data on the **CUCM Groups** tab must be updated from the drop-downs to be the current CUCM node name.

UCPrep Profiles [Standard UC Deployment USA - AXIS] Save Delete Help Back

UCPrep Profile CUCM Date Time Groups CUCM Group CUCM Host Adjustment CUCM SIP Trunk Security Profiles CUCM SIP Profile CUCM Audio Codec Preferences CUCM Application Users More ▾

Call Manager Hostname

Current ID

New Host Identifier

Call Manager Universal Device Template

Call Manager Universal Line Template

Starting Directory Number

Ending Directory Number

Auto-registration Enabled on this Cisco Unified Communications Manager

Current ID

New Host Identifier

Call Manager Universal Device Template

Call Manager Universal Line Template

Starting Directory Number

Ending Directory Number

Auto-registration Enabled on this Cisco Unified Communications Manager

Call Manager Host Adjustment Reference

Name	Description
Call Manager Hostname	Entry area for multiple Call Manager Hostname adjustments.
Current ID	Drop-down providing the current Call Manager node names in the cluster.
New Host Identifier	Free text area to enter the new name as per business standards.
Call Manager Universal Device Template	Drop-down providing the CUCM configured Universal Device Templates. These templates are only required when configuring auto-registration on the Call Manager Node.
Call Manager Universal Line Template	Drop-down providing the CUCM configured Universal Line Templates. These templates are only required when configuring auto-registration on the Call Manager Node.
Starting Directory Number	Free text field for entry of starting directory number for auto-registration.
Ending Directory Number	Free text field for entry of ending directory number for auto-registration.
Auto-registration Enabled on this Cisco Unified Communications Manager	Check box to enable auto-registration on the Call Manager node.

8.14.9. Call Manager SIP Trunk Security Profiles

The input form on the tab shows the fields commonly requiring modification.

UCPrep Profiles [Standard UC Deployment USA - AXIS] Save Delete Help Back Action ▾

UCPrep Profile CUCM Date Time Groups CUCM Group CUCM Host Adjustment CUCM SIP Trunk Security Profiles CUCM SIP Profile More ▾

Sip Trunk Security Profile

Name

Description

Device Security Mode

Incoming Transport Type*

Outgoing Transport Type

Enable Digest Authentication

Accept presence subscription

Accept out-of-dialog refer

Accept unsolicited notification

Accept replaces header

Incoming SIP Port

Call Manager SIP Trunk Security Profiles Reference

Name	Description
Name	Free text field to enter Sip Trunk Security Profile name.
Description	Free text field to enter Sip Trunk Security Profile description.
Device Security Mode	Drop-down providing options: <ul style="list-style-type: none"> • Non Secure • Authenticated • Encrypted
Incoming Transport Type	Drop-down providing options: <ul style="list-style-type: none"> • TLS • TCP and UDP
Outgoing Transport Type	Drop-down providing options: <ul style="list-style-type: none"> • TCP • UDP • TLS
Enable Digest Authentication	Check box to enable Digest Authentication.
Accept presence subscription	Check box to enable Accept of presence subscription.
Accept out-of-dialog refer	Check box to enable Accept out-of-dialog refer.
Accept unsolicited notification	Check box to enable Accept unsolicited notification.
Accept replaces header	Check box to enable Accept replaces header.
Incoming SIP Port	Free text box to set Incoming SIP Port.

8.14.10. Call Manager SIP Profiles

Where values or time settings are shown in the fields of the form when adding a profile, these are the static values corresponding with the Call Manager defaults.

Call Manager SIP Profiles

Name: Custom_SIP_Profile

Description: Custom SIP Profile

Use Fully Qualified Domain Name in SIP Requests:

Phone Parameters: Timer Register Expires (seconds): 3600

Phone Parameters: Timer Register Delta: 5

Phone Parameters: Timer Keep Alive Expires (seconds): 120

Phone Parameters: Timer Subscribe Delta (seconds): 5

Phone Parameters: Timer Subscribe Expires (seconds): 120

Enable OPTIONS Ping to monitor destination status for Trunks with Service Type "None (Default)":

Trunk Configuration: SIP Rel1XX Options: Send PRACK for all 1xx Messages

Trunk Configuration: Calling Line Identification Presentation: Default

Trunk Configuration: Session Refresh Method: [Empty]

Trunk Configuration: Enable ANAT:

Trunk Configuration: Deliver Conference Bridge Identifier:

SDP Information: Allow Presentation Sharing using BFCP:

Call Manager SIP Profiles Reference

Field Name	Description
Call Manager SIP Profiles	Entry box to add any number of SIP Profile definitions.
Name	Free text field to enter name of SIP Profile.
Description	Free text field to enter description of SIP Profile.
Use Fully Qualified Domain Name in SIP Requests	Check box to enable Use Fully Qualified Domain Name in SIP Requests.
Phone Parameters: Timer Register Expires (seconds)	Free text box to adjust the Timer Register Expired timeout. Default 3600
Phone Parameters: Timer Register Delta	Free text box to adjust the Timer Register Delta. Default 5
Phone Parameters: Timer Keep Alive Expires (seconds)	Free text box to adjust the Timer Keep Alive Expires. Default 120
Phone Parameters: Timer Subscribe Delta (seconds)	Free text box to adjust the Timer Subscribe Delta. Default 120
Enable OPTIONS Ping to monitor destination status for Trunks with Service Type "None (Default)"	Check box to Enable OPTIONS Ping.
Trunk Configuration: SIP Rel1XX Options	Drop-down providing options <ul style="list-style-type: none"> • Disabled • Send PRACK if 1xx Contains SDP • Send PRACK for all 1xx Messages
Trunk Configuration: Calling Line Identification Presentation	Drop-down providing options <ul style="list-style-type: none"> • Default • Strict From URI presentation Only • Strict Identity Headers presentation Only
Trunk Configuration: Session Refresh Method	Drop-down providing options <ul style="list-style-type: none"> • Invite • Update
Trunk Configuration: Enable ANAT	Check box to enable ANAT
Trunk Configuration: Deliver Conference Bridge Identifier	Check box to enable Deliver Conference Bridge Identifier.
SDP Information: Allow Presentation Sharing using BFCP	Check box to enable Allow Presentation Sharing using BFCP

8.14.11. Call Manager Audio Codec Preferences

UCPrep Profiles [Standard UC Deployment USA - AXIS] Save Delete Help Back Action ▾

UCPrep Profile CUCM Date Time Groups CUCM Group CUCM Host Adjustment CUCM Audio Codec Preferences More ▾

Audio Codec Preference List +

- +

Configuration

Template to Apply

The Audio Codec Preferences List lends itself to be driven by a configuration template rather than a GUI input of a list of codecs.

The lists are written to Call Manager by selecting any number of configuration templates that have been set up to list out groups of codecs. Typically, a configuration template from the menu **UCPrep Configuration Templates** list view is cloned and modified to show the required codecs and settings.

Audio Codec Preference List Configuration Template Example:

UCPrep Configuration Templates [ucprep_AudioCodecPreferenceList_test] Save Delete Help Back Action ▾

Name*

Description

Foreach Elements

Schema Defaults

Target Model Type*

Merge Strategy

device/cucm/AudioCodecPreferenceList

Codec Names *

-	+	▲	▼	<input type="text" value="AMR-WB (7k-24k)"/>
-	+	▲	▼	<input type="text" value="AMR (5k-13k)"/>
-	+	▲	▼	<input type="text" value="MP4A-LATM 128k"/>
-	+	▲	▼	<input type="text" value="AAC-LD (MP4A Generic)"/>
-	+	▲	▼	<input type="text" value="MP4A-LATM 64k"/>
-	+	▲	▼	<input type="text" value="MP4A-LATM 56k"/>
-	+	▲	▼	<input type="text" value="L16 256k"/>
-	+	▲	▼	<input type="text" value="MP4A-LATM 48k"/>
-	+	▲	▼	<input type="text" value="G.729 8k"/>
-	+	▲	▼	<input type="text" value="G.729a 8k"/>
-	+	▲	▼	<input type="text" value="GSM Half Rate 6k"/>
-	+	▲	▼	<input type="text" value="G.723.1 7k"/>

Name *

Description *

Call Manager Audio Codec Preferences Reference

Name	Description
Audio Codec Preference List	Entry mechanism for any number of Codec lists.
Configuration Template to Apply	Drop-down providing a list of available configuration templates.

8.14.12. Call Manager Application Users

- Application Users can initially be set up from the **UCPrep Application User** menu, to be available from the **Application Users** drop-down on the input form of this tab.
- New Application Users can also be added on the form by entering the user name directly into the **Application Users** input.
- Application User roles are automatically added from the selected **Group Permissions**.

UCPrep Profiles [Standard UC Deployment USA - AXIS] Save Delete Help Back Action ▾

UCPrep Profile | CUCM Date Time Groups | CUCM Group | CUCM Host Adjustment | CUCM SIP Trunk Security Profiles | CUCM SIP Profile | CUCM Application Users **More ▾**

Application Users

User ID: CustomCTIUser ▾

Password:

Repeat Password:

Controlled Devices:

CTI Controlled Device Profiles:

Group Permissions:

- Group: Standard CTI Enabled ▾
- Group: Standard CTI Secure Connection ▾

User ID: SinglewireUser ▾

Password:

Repeat Password:

Controlled Devices:

CTI Controlled Device Profiles:

Group Permissions:

- Group: Third Party Application Users ▾

Call Manager Application Users Reference

Field Name	Description
Application Users	Mechanism for adding an unlimited number of application users to a Call Manager.
User ID	The Application User ID. This drop-down is driven from the UCPrep Application User List in the menu. The idea behind this is to cut down on AppUser misspelling.
Password	Password for the application user
Repeat Password	Confirmation of entered password.
Controlled Devices	Drop-down that provides a list of configured devices on Call Manager should an association be necessary.
CTI Controlled Device Profiles	Drop-down that provides a list of configured device profiles on Call Manager should an association be necessary.
Group Permissions	Drop-down that provides the ability to build group permissions for the application user. The drop-downs will provide all configured groups from the Call Manager.

8.14.13. Call Manager Feature Control Policies

Feature Control Policies are defined by entering policy names and selecting features from the list of check boxes.

Feature Control Policy

Policy Name: FCP-ALL

Policy Description: All Features Enabled

Barge

Call Back

Call Pickup

Conference List

Divert (Alerting)

Divert (Connected)

Forward All

Group Call PickUp

Meet Me

Mobility

Other Call PickUp

Park

Redial

Report Caller

Report Quality

Speed Dial

Policy Name: BargeOnly

Policy Description: Barge Only Enabled

Barge

Call Back

Call Pickup

Call Manager Feature Control Policies Reference

Field Name	Description
Feature Control Policy	Mechanism to enter an unlimited number of Feature Control Policies
Policy Name	Free text field for entry of Feature Control Policy Name.
Policy Description	Free text field for entry of Feature Control Policy Description.
Check boxes to add the individual services into the Feature Control Policy	<ul style="list-style-type: none"> • Barge • Call Back • Call Pickup • Conference List • Divert (Alerting) • Divert (Connected) • Forward All • Group Call PickUp • Meet Me • Mobility • Other Call PickUp • Park • Redial • Report Caller • Report Quality • Speed Dial

8.14.14. Call Manager Route Filters

UCPrep Profiles [Standard UC Deployment USA - AXIS] Save Delete Help Back Action ▾

UCPrep Profile CUCM Date Time Groups CUCM Group CUCM Route Filters More ▾

Route Filters +

- +

Route Filter

Template to ▾

Apply

The Route Filter lends itself to be driven by a configuration template rather than a GUI input of clauses.

The filters are written to Call Manager by selecting any number of configuration templates from the **Route Filter Template to Apply** drop-down on the input form.

Typically, a configuration template from the menu **UCPrep Configuration Templates** list view is cloned and

modified to show the required Route Filter settings.

Example of Route Filter Configuration Template:

UCPrep Configuration Templates [ucprep_RouteFilter] Save Delete Help Back Action ▾

Name*

Description

Foreach Elements

Schema Defaults

Target Model Type*

Merge Strategy

device/cucm/RouteFilter

Dial Plan Name *

Name *

Member

Digits	<input type="text" value="204"/>
Operator *	<input type="text" value="=="/>
Dial Plan Tag Name *	<input type="text" value="AREA-CODE"/>
Priority *	<input type="text" value="1"/>

Digits	<input type="text" value="250"/>
Operator *	<input type="text" value="=="/>
Dial Plan Tag Name *	<input type="text" value="AREA-CODE"/>
Priority *	<input type="text" value="2"/>

Digits	<input type="text" value="289"/>
Operator *	<input type="text" value="=="/>
Dial Plan Tag Name *	<input type="text" value="AREA-CODE"/>
Priority *	<input type="text" value="3"/>

Digits	<input type="text" value="306"/>
Operator *	<input type="text" value="=="/>
Dial Plan Tag Name *	<input type="text" value="AREA-CODE"/>
Priority *	<input type="text" value="4"/>

Digits	<input type="text" value="41[68]"/>
Operator *	<input type="text" value="=="/>
Dial Plan Tag Name *	<input type="text" value="AREA-CODE"/>
Priority *	<input type="text" value="5"/>

Call Manager Route Filters Reference

Name	Description
Route Filters Route Filter Template to Apply	Mechanism to add an unlimited number of route filters via configuration template. Drop-down to provide a list of available configuration templates.

8.14.15. Unity Authentication Policies

UCPrep Profiles [Standard UC Deployment USA - AXIS] Save Delete Help Back : Action ▾

UCPrep Profile CUCM Date Time Groups CUCM Group CUCM Host Adjustment CUCM SIP Trunk Security Profiles Unity Authentication Policies More ▾

Update Voice Mail Authentication Rules

Voice Authentication Rule CFT

Update Web Authentication Rules

Web Authentication Rule CFT

The Unity authentication rule lends itself to be driven by a configuration template rather than a GUI input, since settings commonly do not change and the same group of settings are repeated.

Typically, configuration templates from the menu **UCPrep Configuration Templates** list view are cloned and modified to show the required Voice and Web Authentication Rules.

Example of Authentication Rule Configuration Template:

UCPrep Configuration Templates [ucprep_CUC_VoiceMailAuthRules]

Save Delete Help Back Action ▾

Name*	ucprep_CUC_VoiceMailAuthRules
Description	CUC Voice Authentication Rule
Foreach Elements	+ <input type="text"/>
Schema Defaults	+ <input type="text"/>
Target Model Type*	device/cuc/AuthenticationRule
Merge Strategy	Additive ▾
device/cuc/AuthenticationRule	
Trivial Cred Checking	((False)) ▾
Max Hacks	0
Object Id	<input type="text"/>
Max Days	0
Min Length	3
Hack Reset Time	30
Expiry Warning Days	15
Lockout Duration	30
URI	▾
Location Object Id	{{ pwf.LocationObjectId }}
Min Duration	1440
Display Name	Recommended Voice Mail Authentication Rule
Prev Cred Count	0
Location URI	/vmrest/locations/connectionlocations/{{ pwf.LocationObjectId }} ▾

Unity Authentication Policies Reference

Field Name	Description
Update Voice Mail Authentication Rules	Check box to enable the update of the Voice Mail Authentication Rule from the UCPrep Profile.
Voice Authentication Rule CFT	Drop-down providing a list of available configuration templates.
Update Web Authentication Rules	Check box to enable the update of the Web Authentication Rule from the UCPrep Profile.
Web Authentication Rule CFT	Drop-down providing a list of available configuration templates.

8.14.16. Unity User Templates

The list of user templates shown on the input form are those that are most often changed. Own templates can be added as new entries and options selected from the available drop-downs.

Additional required fields can be added by selecting a created Configuration Template containing these from the **CUC User Template CFT** drop-down.

UCPrep Profiles [Standard UC Deployment USA - AXIS] Save Delete Help Back Action ▾

UCPrep Profile CUCM Date Time Groups CUCM Group CUCM Host Adjustment CUCM SIP Trunk Security Profiles CUCM SIP Profile Unity User Templates More ▾

Unity User Template

Alias:

Display Name:

Based On Template:

Phone System:

Class Of Service:

Partition:

Search Scope:

Message Aging Policy:

CUC User Template CFT:

Alias:

Display Name:

Based On Template:

Phone System:

Class Of Service:

Partition:

Search Scope:

Message Aging Policy:

CUC User Template CFT:

Field Name	Description
Unity User Template	Mechanism to enter an unlimited number of user templates.
Alias	Free text field to enter the User Template Alias.
Display Name	Free text field to enter the User Template Display Name.
Based On Template	Drop-down providing a list of Unity configured templates to use as the required reference.
Phone System	Drop-down providing the Unity configured phone system.
Class Of Service	Drop-down providing the Unity configured and available Class of Service.
Partition	Drop-down providing the Unity configured and available Partitions.
Search Scope	Drop-down providing the Unity configured and available Calling Search Spaces.
Message Aging Policy	Drop-down providing the Unity configured and available Message Aging Policies.
CUC User Template CFT	The VOSS configuration template, which will be used to populate the unexposed fields of a User Template.

8.15. Date Time Groups

8.15.1. Configure Date Time Groups

Use Date Time Groups to define time zones for the various devices that are connected to Cisco Unified CM. Each device exists as a member of only one device pool, and each device pool has only one assigned Date Time Group.

Cisco Unified CM automatically configures a default Date Time Group that is called CMLocal. CMLocal synchronizes to the active date and time of the operating system on the server where Cisco Unified Communications Manager is installed. You can change the settings for CMLocal as desired. Normally, adjust server Date and Time to the local time zone date and time.

Tip: For a worldwide distribution of Cisco Unified IP Phones, create one named Date Time Group for each of the time zones in which you deploy endpoints.

Perform these steps:

1. Log in as provider, reseller, or customer administrator.
2. Make sure that the hierarchy path is set to a customer or site level.
3. If prompted, select the NDL that contains the Cisco Unified CM on which you are configuring the Date Time Group.
4. Perform one of the following:
 - If you logged in as provider or reseller administrator, choose **Device Management > CUCM > Date Time Groups**.
 - If you logged in as a customer administrator, choose **Device Management > Advanced > Date Time Groups**.
5. Click **Add**.

6. Provide the following information:

Field	Description
Group Name	Enter the name that you want to assign to the new Date Time Group. This field is mandatory.
Time Zone	Choose the time zone for the group that you are adding. This field is mandatory.
Separator	Choose the separator character to use between the date fields. This field is mandatory.
Date Format	Choose the date format for the date that displays on the Cisco Unified IP Phones. This field is mandatory.
Time Format	Choose a 12-hour or 24-hour time format. This field is mandatory.
Selected Phone NTP References	To ensure that a phone that is running SIP gets its date and time configuration from an NTP server, select the phone NTP references for the Date Time Group.

7. Click **Save**.

8.16. Locations

8.16.1. Configure Locations

This procedure adds locations.

Locations are used to implement call admission control in a centralized call-processing system. Call admission control enables you to regulate audio quality and video availability by limiting the amount of bandwidth that is available for audio and video calls over links between the locations.

Important: Locations are different to sites. Locations are used by Cisco Unified CM to manage call admission control. Sites are used by VOSS-4-UC to logically group resources.

Perform these steps:

1. Log in as provider, reseller, or customer administrator.
2. Set the hierarchy path to a customer or site level.
3. If prompted, select the NDL that contains the Cisco Unified CM on which you are configuring the location.
4. Navigate to Locations:
 - If you're logged in a provider or reseller administrator, choose **Device Management > CUCM > Locations**.
 - If you're logged in as customer administrator, choose **Device Management > Advanced > Locations**.
5. Click **Add**.
6. On the **Location Information** tab, enter the **Name** of the Location. This field is mandatory.
7. Click the **Intra-Location** tab, and complete at minimum, the mandatory *Intra-Location Fields*.

8. Click the **Between Locations** tab, and complete at minimum, the mandatory *Between Locations Fields*.
9. Click the **RSVP Settings** tab, and complete at minimum, the mandatory *RSVP Settings Fields*.
10. Click **Save**.

Intra-Location Fields

Field	Description
Audio Bandwidth	Enter the maximum amount of audio bandwidth (in kb/s) that is available for all audio calls on the link between this location and other locations. For audio calls, the audio bandwidth includes overhead. Valid values are 0 to 2147483647, where 0 means unlimited bandwidth. This field is mandatory. Note: To improve audio quality, lower the bandwidth setting, so fewer active calls are allowed on this link.
Video Bandwidth	Enter the maximum amount of video bandwidth (in kb/s) that is available for all video calls on the link between this location and other locations. For video calls, the video bandwidth does not include overhead. Valid values are 1 through 2147483647, where 0 means unlimited bandwidth and 1 means no bandwidth. Setting the value to 1 means you cannot make video calls within this location. This field is mandatory.
Immersive Video Bandwidth	Enter the maximum amount of immersive video bandwidth (in kb/s) that is available for all immersive video calls on the link within this location. For video calls, the immersive video bandwidth does not include overhead. Valid values are 1 through 2147483647, where 0 means unlimited bandwidth and 1 means no bandwidth. Setting the value to 1 means you cannot make immersive video calls within this location. This field is mandatory.

Between Locations Fields

Field	Description
Location	Select a location from the list. This field is mandatory.
Weight	Enter the relative priority of this link in forming the Effective Path between any pair of Locations. The Effective Path has the least cumulative Weight of all possible paths. Valid values are 0-100. This field is mandatory.
Audio Bandwidth	Enter the maximum amount of audio bandwidth (in kb/s) that is available for all audio calls on the link between this location and other locations. For audio calls, the audio bandwidth includes overhead. Valid values are 0 to 2147483647, where 0 means unlimited bandwidth. You can also select Unlimited Bandwidth. This field is mandatory.
Video Bandwidth	Enter the maximum amount of video bandwidth (in kb/s) that is available for all video calls on the link between this location and other locations. For video calls, the video bandwidth does not include overhead. Valid values are 1 through 2147483647, where 0 means unlimited bandwidth and 1 means no bandwidth. You can also select Unlimited Bandwidth or None. Setting the value to None means you cannot make video calls between this location and other locations. This field is mandatory.
Immersive Video Bandwidth	Enter the maximum amount of immersive video bandwidth (in kb/s) that is available for all immersive video calls on the link between this location and other locations. For video calls, the immersive video bandwidth does not include overhead. Valid values are 1 through 2147483647, where 0 means unlimited bandwidth and 1 means no bandwidth. You can also select Unlimited Bandwidth or None . Setting the value to None means you cannot make immersive video calls between this location and other locations. This field is mandatory.

RSVP Settings Fields

Field	Description
Location	To change the RSVP policy setting between the current location and a location that displays in this pane, choose a location in this pane. This field is mandatory.
RSVP Setting	<p>To choose an RSVP policy setting between the current location and the location that is chosen in the Location pane at left, choose an RSVP setting from the drop-down list. This field is mandatory.</p> <p>Choose from the following available settings:</p> <ul style="list-style-type: none"> • Use System Default - The RSVP policy for the location pair matches the clusterwide RSVP policy. See topics related to clusterwide default RSVP policy in the Cisco Unified Communications Manager System Guide for details: <ul style="list-style-type: none"> – No Reservation - No RSVP reservations can get made between any two locations. – Optional (Video Desired) - A call can proceed as a best-effort audio-only call if failure to obtain reservations for both audio and video streams occurs. RSVP Agent continues to attempt RSVP reservation and informs Cisco Unified Communications Manager if reservation succeeds. – Mandatory - Cisco Unified Communications Manager does not ring the terminating device until RSVP reservation succeeds for the audio stream and, if the call is a video call, for the video stream too. – Mandatory (Video Desired) - A video call can proceed as an audio-only call if a reservation for the video stream cannot be reserved.

8.17. Device Pools

8.17.1. Configure Device Pools

Device pools define sets of common characteristics for devices. The device pool structure supports the separation of user and location information. The device pool contains system, device, and location-related information.

After adding a new device pool, you can use it to configure devices such as Cisco Unified IP Phones, gateways, conference bridges, transcoders, media termination points, voice-mail ports, CTI route points, and so on.

Perform these steps:

1. Log in as provider, reseller, or customer administrator.
2. If you're logged in as:
 - Provider or reseller administrator: Go to **Apps Management > CUCM > Device Pools**.
 - Customer administrator: Go to **Apps Management > Advanced > CUCM > Device Pools**.
3. Do you want to ...
 - Add a new device pool? Click **Add**. On the dialog, choose the network device list (NDL) where you're adding the device pool; then, click **OK**.

Note: The dialog to choose a NDL does not display if you're adding the device pool instance to site hierarchy node (you won't need to choose a NDL). In this case, you will add the device pool using the NDL associated with the site.

- Edit an existing device pool? Click the line item in the table. Go to step 4.
4. Click through the following tabs to complete at least the mandatory details:
 - Device Pool Settings tab
 - Local Route Group Settings tab
 - Roaming Sensitive Settings tab
 - Device Mobility Related Information tab
 - Geolocation Configuration** tab
 - Incoming Calling Party Settings tab
 - Incoming Called Party Settings tab
 - Caller ID for Calls from This Phone tab
 - Connected Party Settings tab
 - Redirecting Party Settings tab
 5. Click **Save**. The route partition appears in the device pool list.

To modify any of these properties, make your changes and click **Save**.

To delete a device pool, select the check box adjacent to the **Name** column in the group list, and click **Delete**.

Device Pool Settings Tab

Option	Description
Device Pool Name *	Enter the name of the new device pool that you are creating. You can enter up to 50 characters, which include alphanumeric characters, periods (.), hyphens (-), underscores (_), and blank spaces. Default value: None
Cisco Unified CM Group *	Choose the Cisco Unified Communications Manager group to assign to devices in this device pool. A Unified CM group specifies a prioritized list of up to three Unified CMs. The first Unified CM in the list serves as the primary one for that group. The other members of the group serve as backup Unified CMs for redundancy.
Calling Search Space for Auto-registration	Choose the calling search space to assign to devices in this device pool that auto-register with Unified CM. The calling search space specifies partitions that devices can search when attempting to complete a call.
Adjunct CSS	From the drop-down list, choose an existing Calling Search Space (CSS) to use for the devices in this device profile as an adjunct CSS for the Extension Mobility Cross Cluster (EMCC) feature. To configure a new CSS or modify an existing CSS, choose Call Routing > Class of Control > Calling Search Space in Unified CM Administration. When configuring the EMCC feature, the administrator must configure a device pool for each remote cluster. If the remote cluster is located in a different country, the adjunct CSS must embrace the partition with which the emergency patterns of that country associate. This configuration facilitates country-specific emergency call routing. Default value: None
Reverted Call Focus Priority	Choose a clusterwide priority setting for reverted calls that the hold reversion feature invokes. This setting specifies which call type, incoming calls or reverted calls, have priority for user actions, such as going off hook. <ul style="list-style-type: none"> • Default-If you choose this option, incoming calls have priority. • Highest-If you choose this option, reverted calls have priority. The Not Selected setting specifies the reverted call focus priority setting for the default device pool at installation. At installation, incoming calls have priority. You cannot choose this setting in Unified CM. Note: This setting applies specifically to hold reverted calls; it does not apply to parked reverted calls.
Intercompany Media Services Enrolled Group	Choose an Intercompany Media Services Enrolled Group from the drop-down list.

Local Route Group Settings Tab

Option	Description
Local Route Group	From the drop-down, choose the name of the local route group to associate with this device pool.
Route Group	From the drop-down, choose the value for the local route group to associate with this device pool.

Roaming Sensitive Settings Tab

Option	Description
Date/Time Group *	Choose the date/time group to assign to devices in this device pool. The date/time group specifies the time zone and the display formats for date and time. Default value: None
Region *	Choose the Unified CM region to assign to devices in this device pool. The Unified CM region settings specify voice codec that can be used for calls within a region and between other regions. Default value: None
Media Resource Group List	From the drop-down list, choose a media resource group list. A media resource group list specifies a prioritized list of media resource groups. An application selects the required media resource (for example, a music on hold server, transcoder, or conference bridge) from the available media resource groups according to the priority order defined in a media resource group list. Default value: None
Location	Use locations to implement call admission control (CAC) in a centralized call-processing system. CAC enables you to regulate audio quality and video availability. It works by limiting the amount of bandwidth that is available for audio and video calls over links between locations. The location specifies the total bandwidth that is available for calls to and from this location. From the drop-down list, choose the appropriate location for this device pool. A location setting of None or Hub_None means that the locations feature does not track the bandwidth that the devices in this pool consume. A location setting of Phantom specifies a location that enables successful CAC across intercluster trunks that use H.323 protocol or SIP. Default value: None
Network Locale	From the drop-down list, choose the locale that is associated with phones and gateways. The network locale contains a definition of the tones and cadences that the phones and gateways in the device pool in a specific geographic area use. Make sure that you select a network locale that all of the phones and gateways that use this device pool can support. Note: If the user does not choose a network locale, the locale that is specified in the Unified CM clusterwide parameters as Default Network Locale applies. Note: Choose only a network locale that is already installed and supported by the associated devices. The list contains all available network locales for this setting, but not all are necessarily installed. When a device is associated with a network locale that it does not support in the firmware, the device fails to come up. Default value: None

Option	Description
SRST Reference *	<p>From the drop-down list, choose a survivable remote site telephony (SRST) reference to assign to devices in this device pool. Choose from these options:</p> <ul style="list-style-type: none"> • Disable - When you choose this option, devices in this device pool do not have SRST reference gateways that are available to them. • Use Default Gateway - When you choose this option, devices in this device pool use the default gateway for SRST. • Existing SRST references - When you choose an SRST reference from the drop-down list, devices in this device pool use this SRST reference gateway. <p>Default value: None</p>
Connection Monitor Duration	<p>This setting defines the time that the Cisco Unified IP Phone monitors its connection to Unified CM before it unregisters from SRST and reregisters to Unified CM.</p> <p>To use the configuration for the enterprise parameter, you can enter “&#129;1” or leave the field blank. The default value for the enterprise parameter equals 120 seconds.</p> <p>Tip: When you change the value of the connection monitor duration, it applies only to the device pool that is being updated. All other device pools use the value in their own connection monitor duration fields or use the value that is configured in the enterprise parameter.</p>
Single Button Barge	<p>This setting determines whether the devices or phone users in this device pool have single-button access for barge and cBarge. From the drop-down list, choose from these options:</p> <ul style="list-style-type: none"> • Off - When you choose this option, the devices in this device pool have the Single Button Barge/cBarge feature disabled. • Barge - When you choose this option, the devices in this device pool have the Single Button Barge feature enabled. • CBarge - When you choose this option, the devices in this device pool have the Single Button cBarge feature enabled. • Default - When you choose this option, the devices in this device pool use the service parameter setting for the Single Button Barge/cBarge feature. <p>Default value: Default</p>
Join Access Lines	<p>This setting determines whether the Join Access Lines feature is enabled for the devices or phone users in this device pool. From the drop-down list, choose from these options:</p> <ul style="list-style-type: none"> • Off - When you choose this option, the devices in this device pool have the Join Access Lines feature disabled. • On - When you choose this option, the devices in this device pool have the Join Access Lines feature enabled. • Default - When you choose this option, the devices in this device pool use the service parameter setting for the Join Access Lines feature. <p>Default value: Default</p>
Physical Location	<p>Select the physical location for this device pool. The system uses physical location with the device mobility feature to identify the parameters that relate to a specific geographical location.</p> <p>Default value: None</p>

Option	Description
Device Mobility Group	Device mobility groups represent the highest level geographic entities in your network and are used to support the device mobility feature. Default value: None
Wireless LAN Profile Group	Choose a wireless LAN profile group from the drop-down list. Note: You can specify the Wireless LAN Profile Group at the Device Pool level or the individual phone level.

Device Mobility Related Information Tab

Option	Description
Device Mobility Calling Search Space	Choose the appropriate calling search space to be used as the device calling search space when the device is roaming and in the same device mobility group. Default value: None
AAR Calling Search Space	Choose the appropriate calling search space for the device to use when automated alternate routing (AAR) is performed. The AAR calling search space specifies the collection of route partitions that are searched to determine how to route a collected (originating) number that is otherwise blocked due to insufficient bandwidth. Default value: None
AAR Group	Choose the automated alternate routing (AAR) group for this device. The AAR group provides the prefix digits that are used to route calls that are otherwise blocked due to insufficient bandwidth. An AAR group setting of None specifies that no rerouting of blocked calls is attempted. Default value: None
Calling Party Transformation CSS	This setting allows you to localize the calling party number on the device. Make sure that the Calling Party Transformation CSS that you choose contains the calling party transformation pattern that you want to assign to this device pool. Tip: Before the call occurs, the device must apply the transformation by using digit analysis. Note: If you configure the Calling Party Transformation CSS as None for the device pool and you select the Use Device Pool Calling Party Transformation CSS check box in the device configuration window, the transformation does not match and does not get applied. Ensure that you configure the Calling Party Transformation Pattern in a non-null partition that is not used for routing. Default value: None
Called Party Transformation CSS	This setting allows you to localize the called party number on the device. Make sure that the Called Party Transformation CSS that you choose contains the called party transformation pattern that you want to assign to this device pool. Note: If you configure the Called Party Transformation CSS as None , the transformation does not match and does not get applied. Ensure that you configure the Called Party Transformation pattern in a non-null partition that is not used for routing. Default value: None

Geolocation Configuration Tab

Option	Description
Geolocation	From the drop-down list, choose a geolocation. You can choose the Unspecified geolocation, which designates that the devices in this device pool do not associate with a geolocation. Default value: None
Geolocation Filter	From the drop-down list, choose a geolocation filter. If you leave the <None> setting, no geolocation filter gets applied for the devices in this device pool. Default value: None

Incoming Calling Party Settings Tab

Option	Description
National Prefix	Unified CM applies the prefix that you enter in this field to calling party numbers that use National for the Calling Party Numbering Type. You can enter up to eight characters, which include digits, the international escape character (+), asterisk (*), or the pound sign (#). You can enter the word "Default" instead of entering a prefix. If the word "Default" displays in the Prefix field, Unified CM applies the service parameter configuration for the incoming calling party prefix, which supports both the prefix and strip digit functionality.
National Strip Digits	Enter the number of digits, up to the number 24, that you want Unified CM to strip from the calling party number of National type before it applies the prefixes.
National Calling Search Space	This setting allows you to globalize the calling party number of National calling party number type on the device. Make sure that the calling search space that you choose contains the calling party transformation pattern that you want to assign to this device. Before the call occurs, the device must apply the transformation by using digit analysis. If you configure the CSS as None , the transformation does not match and does not get applied. Make sure that you configure the calling party transformation pattern in a non-null partition that is not used for routing.
International Prefix	Unified CM applies the prefix that you enter in this field to calling party numbers that use International for the Calling Party Numbering Type. You can enter up to eight characters, which include digits, the international escape character (+), asterisk (*), or the pound sign (#). You can enter the word "Default" instead of entering a prefix. If the word "Default" displays in the Prefix field in the Device Pool Configuration window, Unified CM applies the service parameter configuration for the incoming calling party prefix, which supports both the prefix and strip digit functionality.
International Strip Digits	Enter the number of digits, up to the number 24, that you want Unified CM to strip from the calling party number of International type before it applies the prefixes.
International Calling Search Space	This setting allows you to globalize the calling party number of International calling party number type on the device. Make sure that the calling party transformation CSS that you choose contains the calling party transformation pattern that you want to assign to this device. Before the call occurs, the device must apply the transformation by using digit analysis. If you configure the CSS as None , the transformation does not match and does not get applied. Ensure that you configure the calling party transformation pattern in a non-null partition that is not used for routing.

Option	Description
Unknown Prefix	Unified CM applies the prefix that you enter in this field to calling party numbers that use Unknown for the Calling Party Numbering Type. You can enter up to eight characters, which include digits, the international escape character (+), asterisk (*), or the pound sign (#). If the word "Default" displays in the Prefix field in the Device Pool Configuration window, Unified CM applies the service parameter configuration for the incoming calling party prefix, which supports both the prefix and strip digit functionality.
Unknown Strip Digits	Enter the number of digits, up to the number 24, that you want Unified CM to strip from the calling party number of Unknown type before it applies the prefixes.
Unknown Calling Search Space	This setting allows you to globalize the calling party number of "Unknown" calling party number type on the device. Make sure that the calling party transformation CSS that you choose contains the calling party transformation pattern that you want to assign to this device. Before the call occurs, the device must apply the transformation by using digit analysis. If you configure the CSS as None , the transformation does not match and does not get applied. Ensure that you configure the calling party transformation pattern in a non-null partition that is not used for routing.
Subscriber Prefix	Unified CM applies the prefix that you enter in this field to calling party numbers that use Subscriber for the Calling Party Numbering Type. You can enter up to eight characters, which include digits, the international escape character (+), asterisk (*), or the pound sign (#). If the word "Default" displays in the Prefix field in the Device Pool Configuration window, Unified CM applies the service parameter configuration for the incoming calling party prefix, which supports both the prefix and strip digit functionality.
Subscriber Strip Digits	Enter the number of digits, up to the number 24, that you want Unified CM to strip from the calling party number of Subscriber type before it applies the prefixes.
Subscriber Calling Search Space	This setting allows you to globalize the calling party number of Subscriber calling party number type on the device. Make sure that the CSS that you choose contains the calling party transformation pattern that you want to assign to this device. Before the call occurs, the device must apply the transformation by using digit analysis. If you configure the CSS as None , the transformation does not match and does not get applied. Ensure that you configure the calling party transformation pattern in a non-null partition that is not used for routing.

Incoming Called Party Settings Tab

Option	Description
National Prefix	<p>Unified CM applies the prefix that you enter in this field to calling party numbers that use National for the Called Party Numbering Type.</p> <p>You can enter up to sixteen (16) characters, which include digits, the international escape character (+), asterisk (*), or the pound sign (#). You can enter the word "Default" instead of entering a prefix.</p> <p>Tip:</p> <p>If the word "Default" displays in the Gateway or Trunk Configuration window, you cannot configure the Strip Digits field in the Gateway or Trunk Configuration window. In this case, Unified CM takes the configuration for the Prefix and Strip Digits fields from the device pool that is applied to the device. If the word "Default" displays in the Prefix field in the Device Pool Configuration window, Unified CM applies the service parameter configuration for the incoming called party prefix, which supports both the prefix and strip digit functionality.</p> <p>Tip:</p> <p>To configure the Strip Digits field, leave the Prefix field blank or enter a valid configuration in the Prefix field. To configure the Strip Digits fields, do not enter the word "Default" in the Prefix field.</p>
National Strip Digits	Enter the number of digits, that you want Unified CM to strip from the called party number of "Unknown" type before it applies the prefixes.
National Calling Search Space	This setting allows you to transform the called party number of "Unknown" called party number type on the device. If you choose None , no transformation occurs for the incoming called party number. Make sure that the calling search space that you choose contains the called party transformation pattern that you want to assign to this device.
International Prefix	<p>Unified CM applies the prefix that you enter in this field to called party numbers that use National for the Called Party Numbering Type. You can enter up to 16 characters, which include digits, the international escape character (+), asterisk (*), or the pound sign (#). You can enter the word "Default" instead of entering a prefix.</p> <p>Tip:</p> <p>If the word "Default" displays in the Prefix field in the Gateway or Trunk Configuration window, you cannot configure the Strip Digits field in the Gateway or Trunk Configuration window. In this case, Unified CM takes the configuration for the Prefix and Strip Digits fields from the device pool that is applied to the device. If the word "Default" displays in the Prefix field in the Device Pool Configuration window, Unified CM applies the service parameter configuration for the incoming called party prefix, which supports both the prefix and strip digit functionality.</p> <p>Tip:</p> <p>To configure the Strip Digits field, leave the Prefix field blank or enter a valid configuration in the Prefix field. To configure the Strip Digits fields, do not enter the word "Default" in the Prefix field.</p>
International Strip Digits	Enter the number of digits that you want Unified CM to strip from the called party number of International type before it applies the prefixes.
International Calling Search Space	This setting allows you to transform the called party number of International called party number type on the device. If you choose None , no transformation occurs for the incoming called party number. Make sure that the calling search space that you choose contains the called party transformation pattern that you want to assign to this device.

Option	Description
Unknown Prefix	<p>Unified CM applies the prefix that you enter in this field to called numbers that use Unknown for the Called Party Numbering Type. You can enter up to sixteen characters, which include digits, the international escape character (+), asterisk (*), or the pound sign (#). You can enter the word "Default" instead of entering a prefix.</p> <p>Tip: If the word "Default" displays in the Prefix in the Gateway or Trunk window, you cannot configure the Strip Digits in the Gateway or Trunk Configuration window. In this case, Unified CM takes the configuration for the Prefix and Strip Digits fields from the device pool that is applied to the device. If the word "Default" displays in the Prefix field in the Device Pool Configuration window, Unified CM applies the service parameter configuration for the incoming called party prefix, which supports both the prefix and strip digit functionality.</p> <p>Tip: To configure the Strip Digits field, leave the Prefix field blank or enter a valid configuration in the Prefix field. To configure the Strip Digits fields, do not enter the word "Default" in the Prefix field.</p>
Unknown Strip Digits	<p>Enter the number of digits, that you want Unified CM to strip from the called party number of "Unknown" type before it applies the prefixes.</p>
Unknown Calling Search Space	<p>This setting allows you to transform the called party number of "Unknown" called party number type on the device. If you choose None no transformation occurs for the incoming called party number. Make sure that the calling search space that you choose contains the called party transformation pattern that you want to assign to this device.</p>
Subscriber Prefix	<p>Unified CM applies the prefix that you enter in this field to called numbers that use Subscriber for the Called Party Numbering Type. You can enter up to sixteen characters, which include digits, the international escape character (+), asterisk (*), or the pound sign (#). You can enter the word "Default" instead of entering a prefix.</p> <p>Tip: If the word "Default" displays in the Prefix field in the Gateway or Trunk Configuration window, you cannot configure the Strip Digits field in the Gateway or Trunk Configuration window. In this case, Unified CM takes the configuration for the Prefix and Strip Digits fields from the device pool that is applied to the device. If the word "Default" displays in the Prefix field in the Device Pool Configuration window, Unified CM applies the service parameter configuration for the incoming called party prefix, which supports both the prefix and strip digit functionality.</p> <p>Tip: To configure the Strip Digits field, leave the Prefix field blank or enter a valid configuration in the Prefix field. To configure the Strip Digits fields, do not enter the word "Default" in the Prefix field.</p>
Subscriber Strip Digits	<p>Enter the number of digits, that you want Unified CM to strip from the called party number of Subscriber type before it applies the prefixes.</p>
Subscriber Calling Search Space	<p>This setting allows you to transform the called party number of Subscriber called party number type on the device. If you choose None, no transformation occurs for the incoming called party number. Make sure that the calling search space that you choose contains the called party transformation pattern that you want to assign to this device.</p>

Caller ID For Calls From This Phone Tab

Option	Description
Calling Party Transformation CSS	From the drop-down list, choose the CSS that contains the Calling Party Transformation Pattern that you want to apply to devices in this device pool. When Unified CM receives a call from a device in this device pool on an inbound line, Unified CM immediately applies the calling party transformation patterns in this CSS to the digits in the calling party number before it routes the call. This setting allows you to apply digit transformations to the calling party number before Unified CM routes the call. For example, a transformation pattern can change a phone extension to appear as an E.164 number.

Connected Party Settings Tab

Option	Description
Connected Party Transformation CSS	This setting is applicable for inbound calls only. This setting allows you to transform the connected party number on the device to display the connected number in another format, such as a DID or E164 number. Unified CM includes the transformed number in the headers of various SIP messages, including 200 OK and mid-call update/reinvite messages for SIP calls and in the Connected Number Information Element of CONNECT and NOTIFY messages for H.323 and MGCP calls. Make sure that the Connected Party Transformation CSS that you choose contains the called party transformation pattern that you want to assign to this device pool. Note: If you configure the Connected Party Transformation CSS as None , the transformation does not match and does not get applied. Ensure that you configure the Calling Party Transformation pattern used for Connected Party Transformation in a non-null partition that is not used for routing.

Redirecting Party Settings Tab

Option	Description
Redirecting Party Transformation CSS	This setting allows you to transform the redirecting party number on the device to E164 format. Unified CM includes the transformed number in the diversion header of invite messages for SIP trunks and in the Redirecting Number Information Element of setup message (for H.323 and MGCP) sent out of Unified CM. Make sure that the Redirecting Party Transformation CSS that you choose contains the called party transformation pattern that you want to assign to this device pool. that the Connected Party Transformation CSS that you choose contains the called party transformation pattern that you want to assign to this device pool. Note: If you configure the Redirecting Party Transformation CSS as None , the transformation does not match and does not get applied. Ensure that you configure the Redirecting Party Transformation CSS in a non-null partition that is not used for routing.

8.17.2. Associate a Local Route Group to a Device Pool

This procedure associates a local route group with an existing device pool for each site.

This allows calls from a device that is tied to a device pool to go out on a specific route group based on the call type. For example, you can associate multiple local route groups such as Emergency Route Group, Primary Local Route Group (for site A), Secondary Local Route Group (for site A), Primary Local Route Group (for site B), and Secondary Local Route Group (for site B).

Local Route groups allow you to specify different route groups for each site (site A and site B) for the respective device pool. Also, you can define a separate call routing option for emergency calls when you associate the Emergency Route Group with a different route group. Hence you can easily define separate call routing options for emergency calls and PSTN calls.

Perform these steps:

1. Log in as provider, reseller or customer administrator.

Warning: When associating a local route group, ensure that you select a valid site under your customer in the hierarchy node breadcrumb at the top of the view. If you attempt to associate a local route group at any other node in the hierarchy, a popup alerts you to select a site hierarchy node.

2. Choose an option:
 - If you logged in as provider or reseller administrator, choose **Apps Management > CUCM > Device Pools**.
 - If you logged in as customer administrator, choose **Apps Management > Advanced > Device Pools**.
3. Click the device pool to be associated.
4. From the **Cisco Unified CM Group** drop-down menu, select a specific Cisco Unified Communications Manager group or leave the Cisco Unified CM Group as Default.
5. Click the **Local Route Group Settings** tab.
6. In the grid, from the **Local Route Group** drop-down menu, select the local route group.
7. In the grid, from the **Route Group** drop-down menu, select the route group or gateway.
8. To save the new local route association, click **Save**.

8.18. CTI Route Points

8.18.1. Add a CTI Route Point

This procedure adds a CTI route point.

A computer telephony integration (CTI) route point designates a virtual device that can receive multiple, simultaneous calls for application-controlled redirection.

Perform these steps:

1. Log in as provider, reseller, or customer administrator.
2. Set the hierarchy path to the site for which you want to configure CTI Route Points.

3. Navigate to the **CTI Route Points** page:
 - If you're logged in as provider or reseller administrator, choose **Apps Management > CUCM > CTI Route Points**.
 - If you're logged in as customer administrator, choose **Apps Management > Advanced > CTI Route Points**.
4. Click **Add**.
5. Complete at minimum, the mandatory *CTI Route Points Fields*.
6. Click + next to **Line**, to associate a line with the CTI Route Point. Complete, at minimum, the mandatory *CTI Route Points Line Fields*.
7. Click **Save**.

8.18.2. CTI Route Points Fields

Option	Description
Device Name *	Enter a unique identifier for this device, from 1 to 15 characters, including alphanumeric, dot, dash, or underscores. This field is mandatory.
Description	Enter a descriptive name for the CTI route point. The description can include up to 50 characters in any language, but it cannot include double-quotes ("), percentage sign (%), ampersand (&), back-slash (\), or angle brackets (<>).
Device Pool *	Choose the name of a Device Pool. The device pool specifies the collection of properties for this device, including Cisco Unified Communications Manager Group, Date Time Group, Region, and Calling Search Space for autoregistration. This field is mandatory.
Common Device Configuration	Choose the common device configuration to which you want this CTI route point assigned. The common device configuration includes the attributes (services or features) that are associated with a particular user. Configure common device configurations in the Common Device Configuration window.
Calling Search Space	From the drop-down list, choose a calling search space. The calling search space specifies the collection of partitions that are searched to determine how a collected (originating) number is routed.
Location *	From the drop-down list, choose the appropriate location for this CTI route point. This field is mandatory. Locations implement call admission control (CAC) in a centralized call-processing system. CAC regulates audio quality and video availability by limiting the amount of bandwidth that is available for audio and video calls between locations. The location specifies the total bandwidth that is available for calls to and from this location. A location setting of Hub_None means that the locations feature does not track the bandwidth that this CTI route point consumes. A location setting of Phantom specifies a location that enables successful CAC across intercluster trunks that use H.323 protocol or SIP.
User Locale	From the drop-down list, choose the locale that is associated with the CTI route point. The user locale identifies a set of detailed information to support users, including language and font. Note: If no user locale is specified, Cisco Unified CM uses the user locale that is associated with the device pool
Media Resource Group List	Choose the appropriate Media Resource Group List. A Media Resource Group List is a prioritized grouping of media resource groups. An application chooses the required media resource, such as a Music On Hold server, from the available media resources. The application chooses according to the priority order defined in a Media Resource Group List. If you choose <none>, Cisco Unified CM uses the Media Resource Group that is defined in the device pool.

Option	Description
Network Hold MOH Audio Source	Choose the audio source that plays when the network starts a hold action. If you do not choose an audio source, Cisco Unified CM uses the audio source that is defined in the device pool. If the device pool does not specify an audio source, the system default is used.
User Hold MOH Audio Source	Choose the audio source that plays when an application starts a hold action. If you do not choose an audio source, Cisco Unified CM uses the audio source that is defined in the device pool. If the device pool does not specify an audio source, the system default is used.
Use Trusted Relay Point Required Field *	<p>Enable or disable whether Cisco Unified CM inserts a trusted relay point (TRP) device with this media endpoint. This field is mandatory. Choose one of the following values:</p> <ul style="list-style-type: none"> • Default - If you choose this value, the device uses the Use Trusted Relay Point setting from the common device configuration with which this device associates. • Off - Choose this value to disable the use of a TRP with this device. This setting overrides the Use Trusted Relay Point setting in the common device configuration with which this device associates. • On - Choose this value to enable the use of a TRP with this device. This setting overrides the Use Trusted Relay Point setting in the common device configuration with which this device associates. <p>A Trusted Relay Point (TRP) device designates an MTP or transcoder device that is labeled as Trusted Relay Point.</p>
Calling Party Transformation CSS	This setting allows you to localize the calling party number on the device. Make sure that the Calling Party Transformation CSS that you choose contains the calling party transformation pattern that you want to assign to this device. Tip: Before the call occurs, the device must apply the transformation by using digit analysis. If you configure the Calling Party Transformation CSS as None , the transformation does not match and does not get applied. Ensure that you configure the Calling Party Transformation Pattern in a non-null partition that is not used for routing.
Geolocation	From the drop-down list box, choose a geolocation. You can choose the Unspecified geolocation, which designates that this device does not associate with a geolocation.
Use Device Pool Calling Party Transformation CSS	To use the Calling Party Transformation CSS that is configured in the device pool that is assigned to this device, select this check box. If you do not select this check box, the device uses the Calling Party Transformation CSS that you configured in the CTI Route Point Configuration window.

8.18.3. CTI Route Points Line Fields

Field	Description
Directory Number *	<p>Enter a dialable phone number. Values can include route pattern wildcards and numeric characters (0 to 9). Special characters such as a question mark (?), exclamation mark (!), backslash (\), brackets ([]), plus sign (+), dash (-), asterisk (*), caret (^), pound sign (#), and an X are also allowable. Special characters that are not allowed are a period (.), at sign (@), dollar sign (\$), and percent sign (%). This field is mandatory.</p> <p>At the beginning of the pattern, enter \+ if you want to use the international escape character +. For this field, \+ does not represent a wildcard; instead, entering \+ represents a dialable digit.</p>
Route Partition *	<p>Choose the partition to which the directory number belongs. Make sure that the directory number that you enter in the Directory Number field is unique within the partition that you choose. If you do not want to restrict access to the directory number, choose <None> for the partition.</p>
Index	<p>This field is the line position on the device. If left blank, an integer is automatically assigned.</p>
External Phone Number Mask	<p>Indicate phone number (or mask) that is used to send Caller ID information when a call is placed from this line.</p> <p>You can enter a maximum of 24 number, the international escape character +, and "X" characters. The Xs represent the directory number and must appear at the end of the pattern. For example, if you specify a mask of 972813XXXX, an external call from extension 1234 displays a caller ID number of 9728131234.</p>
Line Text Label	<p>Use this field only if you do not want the directory number to show on the line appearance. Enter text that identifies this directory number for a line and phone combination.</p> <p>Suggested entries include boss name, department name, or other appropriate information to identify multiple directory numbers to a secretary or assistant who monitors multiple directory numbers.</p>
Display (Internal Caller ID)	<p>Leave this field blank to have the system display the extension.</p> <p>Use a maximum of 30 characters. Typically, use the username or the directory number. If using the directory number, the person receiving the call may not see the proper identity of the caller.</p>
ASCII Display (Caller ID)	<p>This field provides the same information as the Display (Internal Caller ID) field, but limit input to ASCII characters. Devices that do not support Unicode (internationalized) characters display the content of the ASCII Display (Internal Caller ID) field.</p>
Ring Setting (Phone Active)	<p>If applicable, the ring setting that is used when this phone has another active call on a different line. Choose one of the following options:</p> <ul style="list-style-type: none"> • Use system default • Disable • Flash only • Ring once • Ring • Beep only

Field	Description
Ring Setting (Phone Idle)	If applicable, the ring setting for the line appearance when an incoming call is received and no other active calls exist on that device. Choose one of the following options: <ul style="list-style-type: none"> • Use system default • Disable • Flash only • Ring once • Ring
Recording Option	This field determines the recording option on the line appearance of an agent. The default recording option is Call Recording Disabled. Choose one of the following options: <ul style="list-style-type: none"> • Call Recording Disabled - Calls made on this line appearance cannot be recorded. • Automatic Call Recording Enabled - Calls made on this line appearance are recorded automatically. • Selective Call Recording Enabled - Calls made on this line appearance can be recorded using a softkey or programmable line key that is: <ul style="list-style-type: none"> – assigned to the device – a CTI-enabled application – both interchangeably
Recording Profile	This field determines the recording profile on the line appearance of an agent.
Recording Media Source	This field determines the recording media source option on the line appearance. Choose one of the following options: <ul style="list-style-type: none"> • Gateway Preferred - Voice gateway is selected as the recording media source when the call is routed through a recording enabled gateway. • Phone Preferred - Phone is selected as the recording media source.
Monitoring Calling Search Space	The monitoring calling search space of the supervisor line appearance must include the agent line or device partition to allow monitoring the agent.
Visual Message Waiting Indicator Policy	Use this field to configure the handset lamp illumination policy. Choose one of the following options: <ul style="list-style-type: none"> • Use System Policy (The directory number refers to the service parameter "Message Waiting Lamp Policy" setting.) • Light and Prompt • Prompt Only • Light Only • None
Audible Message Waiting Indicator Policy	Use this field to configure an audible message waiting indicator policy. Choose one of the following options: <ul style="list-style-type: none"> • Off • On - When you select this option, you receive a stutter dial tone when you take the handset off hook. • Default - When you select this option, the phone uses the default that was set at the system level.
Log Missed Calls	If selected, Cisco Unified CM logs missed calls in the call history for the shared line appearance on the phone.

Field	Description
Busy Trigger	This setting, working with Maximum Number of Calls and Call Forward Busy, determines the maximum call number for the line. Use this field with Maximum Number of Calls for CTI route points. The default specifies 4500 calls
Maximum Number of Calls	For CTI route points, you can configure up to 10,000 calls for each port. The default specifies 5000 calls. Use this field with the Busy Trigger field. Note: We recommend that you set the maximum number of calls to no more than 200 per route point. This prevents system performance degradation. If the CTI application needs more than 200 calls, we recommend that you configure multiple CTI route points.
Dialed Number	Select to display original dialed number upon call forward.
Redirected Number	Select to display the redirected number upon call forward.
Caller Number	Select to display the caller number upon call forward.
Caller Name	Select to display the caller name upon call forward.
End User, User ID	The User ID of a user associated with the line.

8.19. Time Periods and Schedules

8.19.1. Configure Time Periods

A time period specifies a time range that includes a start time and end time. Time periods also specify a repetition interval either as days of the week or a specified date on the yearly calendar. You define time periods and then associate the time periods with time schedules. A particular time period can be associated with multiple time schedules.

Note: VOSS-4-UC provides one **All the time** time period. The **All the time** period is a special, default time period that includes all days and hours, and cannot be deleted.

1. Sign in as provider, reseller, or customer administrator.
2. Make sure that the hierarchy path is set to the node where you want to configure the new time period.
3. Perform one of these options as appropriate:
 - If you logged in as provider or reseller administrator, choose **Apps Management > CUCM > Time Periods**.
 - If you logged in as customer administrator, choose **Apps Management > Advanced > Time Periods**.
4. Perform one of these options as appropriate:
 - To add a new time period, click **Add**, then go to Step 5.
 - To edit an existing time period, choose the time period to be updated by clicking it in the list of time periods, then go to Step 6.
5. If the **Network Device List** popup window appears, choose the NDL for the time period from the drop-down menu. The window appears when you are on a nonsite hierarchy node. If you are at a site hierarchy node, the NDL associated with the site is automatically used.

Note:

The **Network Device List** drop-down menu only appears when a time period is added; it does not appear when you edit a time period.

6. Enter a unique name for the new time period in the **Name** field, or modify the existing Name if desired. This field is mandatory. Enter a name in the **Time Period Name** field. The name can comprise up to 50 alphanumeric characters. It can contain any combination of spaces, periods (.), hyphens (-), and underscore characters (_).

Use concise and descriptive names for your time periods. The hours_or_days format usually provides a sufficient level of detail and is short enough to enable you to quickly and easily identify a time period. For example, office_M_to_F identifies a time period for the business hours of an office from Monday to Friday.

7. Complete the other fields as appropriate.

Op-tion	Description
De-scrip-tion	Enter a description for the time period.
Time of Day Start	From the drop-down list, choose the time when this time period starts. The available listed start times comprise 15-minute intervals throughout a 24-hour day. Default: No Office Hours Note: To start a time period at midnight, choose the 00:00 value.
Time of Day End	From the drop-down list, choose the time when this time period ends. The available listed end times comprise 15-minute intervals throughout a 24-hour day. Default: No Office Hours Note: To end a time period at midnight, choose the 24:00 value.

8. Choose one of these repetition periods and complete the required information:

Note:

If you choose to repeat the time period by the week, the **Repeat Every Year** fields are dimmed and cannot be edited. If you choose to repeat the time period by the year, the **Repeat Every Week** fields are dimmed and cannot be edited.

Repeat Every Week - For time periods defined by the week

- a. From the **Start Day** drop-down menu, choose a day of the week on which this time period starts.
- b. From the **End Day** drop-down menu, choose a day of the week on which this time period ends.

Repeat Every Year - For time periods defined by the year

- a. From the **Start Month** drop-down menu, choose a month of the year on which this time period starts.
- b. Enter a number from 1 to 31 in the **Start Date** field to define the day of the month on which this time period starts.
- c. From the **End Month** drop-down menu, choose a month of the year on which this time period ends.

- d. Enter a number from 1 to 31 in the **End Date** field to define the day of the month on which this time period ends.
 - For weekly time intervals, choose a Start Day on Mon and End Day of Fri for a time period starting on Mondays and ending on Fridays.
 - For weekly time intervals, choose Start Day and End Day values of Sat to define a time period that applies only on Saturdays.
 - For yearly time intervals, choose Start Month value of Jan and Start Date of 15, and End values of Mar and 15 to choose the days from January 15 to March 15.
 - For yearly time intervals, choose Start and End values of Jan and 1 to specify January 1 as the only day during which this time period applies.
9. To save the new or updated time period, click **Save**.

Associate time periods with time schedules. See “Configure Time Schedules”.

Note:

You cannot delete time periods that time schedules are using. Before deleting a time period that is currently in use, perform either or both of these tasks as appropriate:

- Assign a different time period to any time schedule that is using the time period that you want to delete.
- Delete the time schedules that are using the time period that you want to delete.

8.19.2. Configure Time Schedules

This procedure assigns a time period to a time schedule.

A time schedule includes a group of time periods. Time schedules are assigned to partitions to set up time-of-day call routing. Time schedules determine the partitions where calling devices search when they are attempting to complete a call during a particular time of day. Multiple time schedules can use a single time period.

Prerequisites:

- You can assign the time period to a time schedule after you have configured a time period in **Configure Time Periods**.

Note: VOSS-4-UC provides one ‘All the time’ schedule. The ‘All the time’ schedule is a special, default time schedule that includes all days and hours, and cannot be deleted.

Perform these steps:

1. Log in as provider, reseller, or customer administrator.
2. Make sure that the hierarchy path is set to the node where you want to create the new time schedule.
3. Perform one of the following:
 - If you logged in as provider or reseller administrator, choose **Apps Management > CUCM > Time Schedules**.
 - If you logged in as a customer administrator, choose **Apps Management > Advanced > Time Schedules**.
4. Perform one of the following:

- To add a new time schedule, click **Add**, then go to Step 5.
- To edit an existing time schedule, choose the time schedule to be updated by clicking it in the list of time schedules. Go to Step 6.

5. If the **Network Device List** popup window appears, select the NDL for the time schedule from the drop-down menu. The window appears when you are on a nonsite hierarchy node. If you are at a site hierarchy node, the NDL associated with the site is automatically used.

Note:

The **Network Device List** drop-down only appears when a time schedule is added; it does not appear when you edit a time schedule.

6. Enter a unique name for the new time schedule in the **Name** field, or modify the existing Name if desired. This field is mandatory. The name can comprise up to 50 alphanumeric characters. The name of the time schedule can contain any combination of spaces, periods (.), hyphens (-), and underscore characters (_).
7. (Optional) Enter a description for the time schedule in the **Description** field.
8. Click + to open the **Time Periods** form.
9. From the **Time Period** drop-down box, choose a time period for the time schedule.
10. Repeat Steps 8 and 9 to add another time period to the time schedule.

Note:

- If multiple time periods are associated with a schedule where the time periods overlap, time periods with Day of Year settings take precedence over time periods with Day of Week settings. Day of Year is applicable when Year Start value is set and the End value is left blank.

Example: If a Time Period configured for January 1 is configured as No Office Hours and another time period is configured for the same day of the week (for example, Sunday to Saturday) as 08:00 to 17:00, the time period for January 1 is used. In this example, No Office Hours takes precedence.

- Time interval settings take precedence over No Office Hour settings for the same day of the year or day of the week.

Example: One time period specifies for Saturday as No Office Hours. Another time period specifies Saturday hours of 08:00 to 12:00. In this example, the resulting time interval specifies 08:00 to 12:00 for Saturday.

- If multiple time periods are associated with a schedule where the time periods overlap, time periods with Day of Week settings take precedence over time periods with Range of Days settings. Range of Days applies to when Year Start and End values are set, even if they are configured for the same day.

Example: If a Time Period configured for Day of Week (for example, Sunday to Saturday) is configured as No Office Hours and another time period is configured for January 1 until December 31 as 08:00 to 17:00, the time period for Day of Week is used. In this example, No Office Hours takes precedence.

11. To save the new time schedule, click **Save**. To save the updated time schedule, click **Update**.
12. Repeat Steps 3 to 11 to configure another time schedule.

Next Steps

You cannot delete time schedules that partitions are using. Before deleting a time schedule that is currently in use, perform either or both of the following tasks:

- Assign a different time schedule to any partitions that are using the time schedule that you want to delete.
- Delete the partitions that are using the time schedule that you want to delete.

Warning: Before you delete a time schedule, check carefully to ensure that you are deleting the correct time schedule. You cannot retrieve deleted time schedules. If you accidentally delete a time schedule, you must rebuild it.

9. Microsoft Apps Management

9.1. Microsoft Tenant

9.1.1. Microsoft Configuration Setup

VOSS-4-UC provides management and administration for Microsoft 365 and Microsoft Team's cloud assets. This document outlines the required authentication steps needed to configure a connection between a Microsoft 365 and Teams Tenant and VOSS-4-UC.

You will need to be a Global Administrator of the Microsoft 365 and Teams Tenant to complete the following steps:

Step 1: Register An Application Object (Access to Microsoft Azure AD)

The application objects describe the VOSS-4-UC application to Azure AD and can be considered the definition of the VOSS-4-UC application, allowing the Azure AD service to know how to issue tokens to the VOSS-4-UC application based on its settings.

To register your application and add the app's registration information to your solution, follow these steps:

Note: If you have access to multiple tenants, use the Directory + subscription filter in the top menu to select the tenant in which you want to register an application.

1. Sign in to the Azure portal (portal.azure.com) using your administrator credentials.

Important: Manage the Security defaults for the tenant as follows:

- Set **Access management for Azure resources** to **No**.

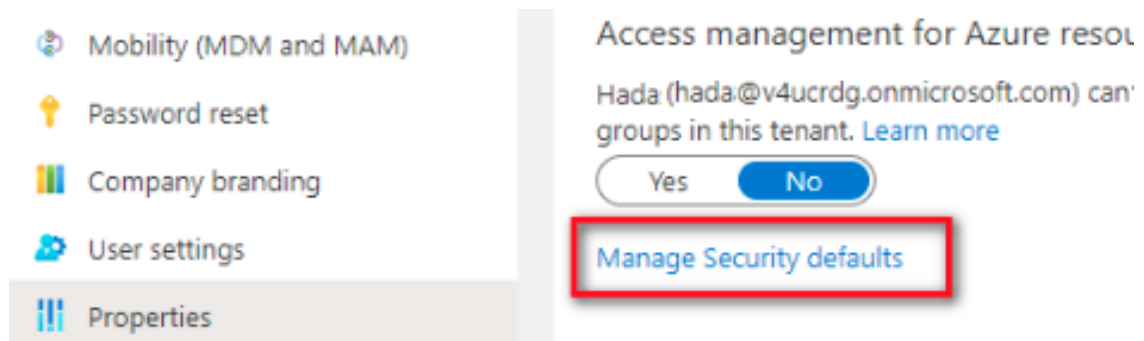

- Set **Enable Security defaults** to **No**.

Enable Security defaults ×

Security defaults is a set of basic identity security mechanisms recommended by Microsoft. When enabled, these recommendations will be automatically enforced in your organization. Administrators and users will be better protected from common identity related attacks.

[Learn more](#)

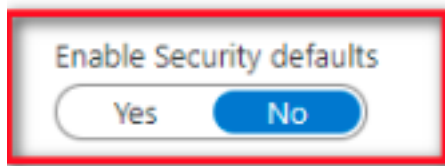

These settings are required since API access does not cater for 2-step authentication

2. Search for and select **Azure Active Directory**.
3. Under **Manage**, select **App registrations > New registration**.

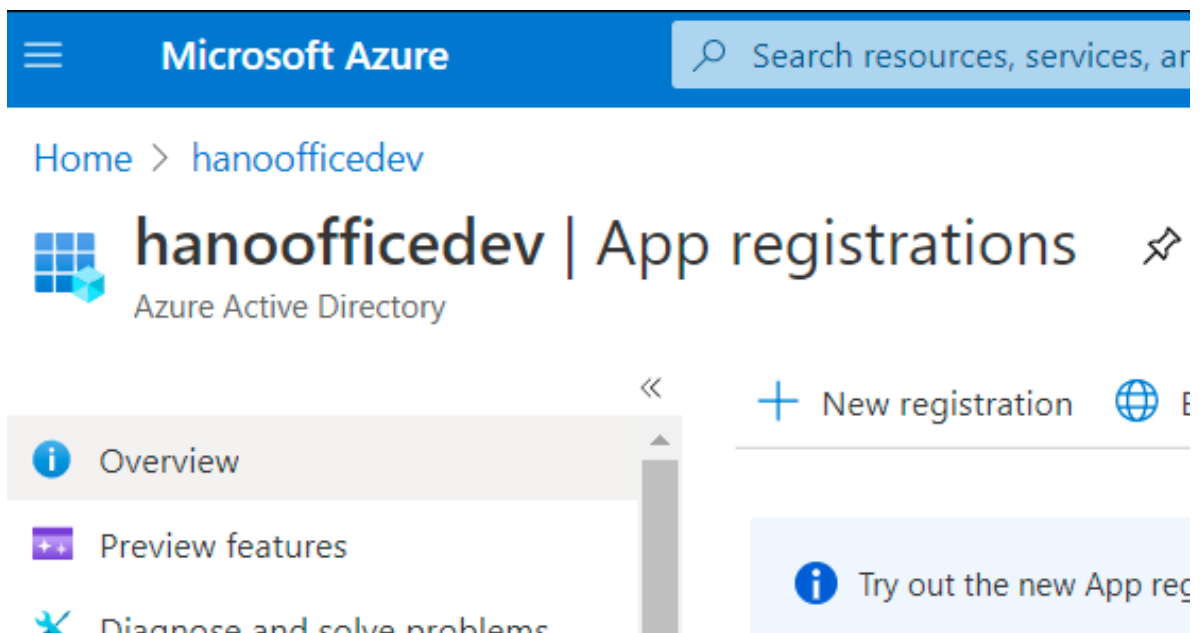

4. Enter a Name for your application, for example `VOSS4UC`. Users of your application might see this name, and you can change it later.
5. Select **Accounts in this organization only**
6. Ignore the **Redirect URI** section
7. Select **Register**.

8. Under **Manage**, select **Certificates & secrets**.

The screenshot shows the Microsoft Azure portal interface. At the top, there's a blue header with 'Microsoft Azure' and a search bar. Below the header, the breadcrumb path is 'Home > hanoofficedev > VOSS4UC'. The main heading is 'VOSS4UC | Certificates & secrets'. On the left, there's a navigation pane with 'Manage' expanded, showing 'Branding', 'Authentication', and 'Certificates & secrets' (which is selected). The main content area has a search bar, a 'Got feedback?' link, and a section titled 'Certificates' with a description: 'Certificates can be used as secrets to prove the applicati...'. Below this, there's an 'Upload certificate' button and a 'Thumbprint' section.

9. Under **Client secrets**, select **New client secret**, enter a name, and then select **Add**. The add actions opens the **Add a client secret** pane. Record the secret value in a safe location for use in a later step. The secret is used in the MS Connection configuration in VOSS-4-UC.

Important: The secret value is *only* available when the secret is created and not later. If the value is not copied on time, a new secret will be required.

The screenshot shows the 'Client secrets' page. It has a title 'Client secrets' and a description: 'A secret string that the application uses to prove its identity when requesting a token. Also can be referred to as application password.' Below the description is a '+ New client secret' button. A table lists the existing client secrets:

Description	Expires	Value	Secret ID
FirstSecret	8/4/2023	tS2V3Ey6wy5_9p~TCF~U5AZQAq	bc5d693b-fc6b-4e7

10. Under **Manage**, select **API Permissions > Add a permission**. Select **Microsoft Graph**.

Home > hanoofficedev > VOSS4UC

VOSS4UC | API permissions

Search (Ctrl+/) Refresh Got feedback?

Overview

Quickstart

Integration assistant

Manage

Branding

Authentication

Certificates & secrets

Token configuration

API permissions

Expose an API

The "Admin consent required" column shows t

Configured permissions

Applications are authorized to call APIs when they all the permissions the application needs. [Learn m](#)

+ Add a permission ✓ Grant admin consen

API / Permissions name	Type
Microsoft Graph (1)	
User.Read	Delegated

11. Select **Application permissions**.
12. Select **Grant Admin Consent** to allow `User.Read.All`
13. Under **User node**, select:
 - `User.Read.All`
 - `Directory.Read.All`
14. Select **Add permissions**

Step 2: Create a Service Account (Access to Microsoft Teams)

1. Sign in to the Azure portal (portal.azure.com)
2. On the Admin home page, go to **Users > Active users** and click on button **Add a user**
3. Enter a **Display Name**
4. Enter a **User Name**
5. Ensure that the domain is the `company.onmicrosoft.com` one
6. Select **Let me create a password** and enter a strong one
7. Ensure **Require this user to change their password when they first sign in** is *not* ticked
8. Once the user is created, assign the **Global Administrator** role from the **Assigned Roles** menu option.

Important: Take note of the Username and Password - it will be needed to configure the VOSS-4-UC connection.

Step 3: Configure the MS Connection in V4UC

The Microsoft 365 information required to set up a MS Tenant app in VOSS-4-UC is found as follows:

Field	Source
Client ID	Overview > Essentials > Application (client) ID
Tenant ID	Overview > Essentials > Directory (tenant) ID
Secret	The secret value is shown during the app registration only once, and should be recorded at that point.

The screenshot displays the Microsoft Azure portal interface. On the left, the 'New Record' form for Microsoft 365 is visible, with fields for Name, Description, Proxy Host, Proxy Username, Proxy Password, Use Proxy, Admin Username, Admin Password, Client ID, Tenant ID, and Secret. On the right, the 'VOSS4UC' application details are shown, including the Application (client) ID, Object ID, and Directory (tenant) ID, which are highlighted in red. Yellow arrows point from these highlighted fields to the corresponding fields in the form.

Use this information to set up a MS Tenant app in VOSS-4-UC. For steps to do this, see: [Configure Microsoft Tenant on VOSS-4-UC](#)

9.1.2. Configure Microsoft Tenant on VOSS-4-UC

This procedure adds a Microsoft tenant at a customer hierarchy, for Microsoft 0365 and Microsoft Teams.

Note: You will need to add a Microsoft tenant at each customer hierarchy.

Pre-requisites:

- Configure Microsoft for integration with VOSS-4-UC. See [Microsoft Configuration](#)
- [Microsoft Configuration Setup](#)
- Create customers for the hierarchy setup.
- Enable Microsoft in the VOSS-4-UC Admin Portal [Global Settings](#) (Enabled Services tab).
- Configure role-based access controls: create admin users, create menu layouts, create user roles (and assign the menu layouts to the user roles)
- Configure the [SMTP Server](#) (if required)

Perform these steps:

1. Log in to the Admin portal as provider level admin (or higher).
2. Go to (default menu) **Apps Management > Microsoft Tenant**.
3. Click the Plus icon (+) to add a tenant.
4. On the organization level picker, choose the customer where you're adding the tenant.
5. Configure the **Tenant** name and description. See: [Microsoft Configuration Setup](#).
6. Configure the **Microsoft Teams PowerShell** proxy host service account credentials:

Note: For the Windows PowerShell proxy host setup, see the [Microsoft Windows PowerShell Proxy Server Installation and Upgrade Guide](#).

Host	The Windows PowerShell host service account name, either a host name or IP address.
User-name	The Windows PowerShell host service account username.
Password	The Windows PowerShell host service account password.

7. Configure the **Microsoft Teams HTTP Proxy**, which serves as an intermediary between VOSS-4-UC and Microsoft Teams:

Use HTTP Proxy	Defines whether to use the internet (HTTP) proxy, if one is set up between the Windows PowerShell and the Microsoft Cloud.
Use HTTP Proxy Authentication	Defines whether the HTTP proxy server requires credentials. When set to <i>True</i> , Username and Password are mandatory.
Username	Windows PowerShell proxy username required for the HTTP proxy server. Mandatory when Use HTTP Proxy Authentication is set to <i>True</i> .
Password	Windows PowerShell proxy password for the HTTP proxy server. Mandatory when Use HTTP Proxy Authentication is set to <i>True</i> .

8. In **Microsoft Teams**, configure credentials for the VOSS-4-UC admin account used to access Microsoft Teams. See [Microsoft Configuration Setup](#).
9. In **Microsoft 365**, configure application credentials assigned by Azure:

Client ID	The client ID (application ID) assigned by the Azure application registration portal. See: Microsoft Configuration Setup .
Tenant ID	Enter your unique Microsoft 365 tenant globally unique ID (GUID). See Microsoft Configuration Setup .
Secret	Enter your secret passphrase (Microsoft Graph API secret authentication, either a client ID password or public/private key pair certificate, used to access Microsoft Cloud service resources). See: Microsoft Configuration Setup .

10. Click **Save**. The customer tenant is created.
11. Click the **Sync All** toolbar icon. A full pull sync is triggered from the Microsoft Cloud to import Microsoft users, tenant dial plan, licenses, and policies to the customer level. Wait for all data to sync in. Go to Next Steps.

Next Steps

1. Configure the customer-wide site defaults doc (SDD), CUSTOMER_TEMPLATE. See [Site Defaults Doc Templates](#).
2. Add network device lists (NDLs) with Microsoft 365 and Microsoft Teams tenant details. NDLs are required when adding sites. See [Add a Network Device List \(NDL\)](#).
3. Create sites.
4. Run the overbuild. See: [Overbuild for Microsoft](#).
5. Go to [VOSS-4-UC Configuration and Sync](#)

Related Topics

- [Microsoft Overview in the Core Feature Guide](#)
- [Network Device Lists \(NDL\) in the Core Feature Guide](#)

10. LDAP Management

10.1. LDAP Integration

LDAP servers can be integrated with VOSS-4-UC for these two purposes:

- User synchronization - sync users from LDAP into VOSS-4-UC and use LDAP to authenticate users. In this setup, the user accessing the system provides credentials via the VOSS-4-UC login page and an authentication request is sent to the appropriate LDAP server based on the user setup.
- User authentication only - use LDAP to authenticate users in VOSS-4-UC (either added locally or synced from Cisco Unified CM)

10.1.1. LDAP Authentication and VOSS-4-UC Credential Policies

VOSS-4-UC supports LDAP authentication as either standalone (LDAP Authentication only) or in conjunction with LDAP syncing of the users. The user accessing the system provides credentials via the VOSS-4-UC login page and an authentication request is sent to the appropriate LDAP server(s) based on the user setup.

The username and password provided needs to match that in the LDAP server based on the LDAP field selected for username. This username is used to map to the requisite user in VOSS-4-UC to determine access, role, and so on after successful authentication. By default, this mapping is done based on the LDAP field used (as defined in the LDAP setup in VOSS-4-UC) that matches the VOSS-4-UC username. However, if required, VOSS-4-UC does allow you to map non-matching usernames as part of the authentication setup for the user. This is useful when you need to have a different username in VOSS-4-UC and the UC apps than you have in LDAP.

When using LDAP Authentication, the password rules part of the credential policy in VOSS-4-UC do not apply as the password is managed in the directory. Other credential policy rules like session length are applied as they are managed by VOSS-4-UC.

User authentication only is not available for OpenLDAP.

Note:

- To use LDAP for authentication only, you must have VOSS-4-UC 10.6(3) or later.
 - Since LDAP servers support case insensitive search base DN's, VOSS-4-UC supports this case insensitivity. For example, on an LDAP server, the following search base DN's are equal:
 - CN=Users,DC=example,DC=com
 - cn=Users,dc=example,dc=com
-

10.1.2. LDAP Sync Scenarios

User synchronization is available for Active Directory (AD) and OpenLDAP.

Two sync scenarios are possible:

- “Top Down”: when the system is syncing users *directly from the LDAP directory*. One or more LDAP directories is the source of the user data. This setup controls how users are matched to be pulled in (for example, OU definition, LDAP filter, field filters, etc). It also provides the best scenario for the flow-through provisioning functionality.
- “Bottom Up”: when the system is syncing users *indirectly from the LDAP directory*, i.e. where applications are integrated and syncing the users from the LDAP directory. For example, the system syncs via the Cisco Unified CM which is syncing to LDAP.

10.1.3. LDAP Sync Lists

With LDAP sync, consider the following lists. They are here arranged in order of override precedence:

Override Order

1. *Always Synced list* - fields required to list LDAP Users on the GUI
2. *Drop Field List* - fields never imported from LDAP
3. *Data Sync Blacklist* - a change in these fields does not trigger an update
4. *Model Type List* - from the LDAP data sync; set up and used in scheduled syncs
5. *LDAP Sync List* (manual or from CFT) - fields to be imported from LDAP as set up with the LDAP server

Details of these lists are provided below:

Always Synced List

A number of fields are *always synced*, since these are required to list LDAP Users on the GUI:

Column Name	Field Name
Cn	cn
Uid	uid
Description	description
Mail	mail
User Principal Name	userPrincipalName
SAM Account Name	sAMAccountName

Drop Field List

If any items in the LDAP Sync List are contained in the `DROP_FIELD_LIST` below, these are *not* synced, since they are not considered during any sync. This list is fixed in the system and is not configurable:

```
DROP_FIELD_LIST=[
  'photo',
  'jpegPhoto',
  'audio',
  'thumbnailLogo',
  'thumbnailPhoto',
  'userCertificate',
  'logonCount',
  'adminCount',
  'lastLogonTimestamp',
  'whenCreated',
  'uSNCreated',
  'badPasswordTime',
  'pwdLastSet',
  'lastLogon',
  'whenChanged',
  'badPwdCount',
  'accountExpires',
  'uSNChanged',
  'lastLogoff',
  'dSCorePropagationData'
]
```

Data Sync Blacklist

Refer to Data Sync Blacklist in the Advanced Configuration Guide.

An LDAP Sync List will *not* override any of the Data Sync Blacklist attributes - default or custom - in `data/Settings`. In other words, if a field is in both the LDAP Sync List and the Data Sync Blacklist and the field value is different on LDAP server, then when syncing the LDAP server, the LDAP sync will *not* trigger any update for the LDAP entity during sync.

Existing Model Type List

Given an existing LDAP Server with a LDAP Sync List configured, when executing a Data Sync against the LDAP server, then the *existing Model Type List functionality* from the LDAP data sync is maintained and takes precedence over the LDAP Sync List.

See:

- [Create a Targeted Model Type List](#)
- [Controlling a Data Sync with a Model Type List](#)

LDAP Sync List

A new LDAP server or one that existed in the system prior to release 19.3.4 allows you to choose the **LDAP Sync List Option**:

- No sync list
- Create sync list manually
- Create sync list from template

The template (CFT) can also be created and applied to a server - see [LDAP Sync List Configuration Templates](#).

Important: Besides the sync override order indicated above, manual or template sync lists are bound by the following considerations:

- If no sync list is set up, LDAP sync will not be affected by this list.
- If the default or selected sync list used for a server is modified, a full sync is required during the next scheduled or manual sync, for example, from the **Sync and Purge** menu. Until a full LDAP user import is done, user details will be updated in the local cache when a specific user management page opens. For more about data sync and data sync cache, see [Data Sync Types](#).

It is therefore recommended that such changes and sync be scheduled for off-peak times, particularly in the case where there are many users so that a large sync is required.

- For users that are targeted for Cisco-based services, it is required to have a field mapped to the surname field for users. It is therefore important to include a field in the Sync List that is mapped to the 'surname' field, typically `sn`.

For details on the LDAP Sync List on the LDAP server, see: [Set up an LDAP Server](#).

Note: By default LDAP user details shown on the GUI display all `device/ldap/user` fields. It is therefore recommended to create a FDP for `device/ldap/user` to contain *only* the fields from your LDAP Sync List in order to view LDAP user details according to your configuration.

10.1.4. LDAP Sync List Configuration Templates

Administrators can also clone the default sync list Configuration Templates to a hierarchy and modify these for use during initial LDAP server setup. The modified CFTs will then be available at the hierarchy on the **Sync List** tab from the **LDAP Sync List Template** drop-down list.

Two default CFTs are provided and can be cloned:

- **Ldap Sync List Microsoft Active Directory**
- **Ldap Sync List Open Ldap**

The default CFT fields are:

Ldap Sync List Microsoft Active Directory	Ldap Sync List Open Ldap
Model Type: device/ldap/user	Model Type: device/ldap/InetOrgPerson
sAMAccountName	uid
mail	mail
givenName	givenName
sn	sn
title	title
department	departmentNumber
displayName	displayName
employeeNumber	employeeNumber
employeeType	employeeType
homePhone	homePhone
ipPhone	
telephoneNumber	telephoneNumber
mobile	mobile
otherMailbox	
facsimileTelephoneNumber	facsimileTelephoneNumber
l	l
c	
streetAddress	
st	street
postalCode	postalCode
physicalDeliveryOfficeName	physicalDeliveryOfficeName
manager	manager
memberOf	memberOf
objectClass	objectClass
o	o
ou	ou

If new LDAP attribute names are added to the cloned CFT and modified on the GUI, type the names in. Initially, all attribute names are imported. The full attribute list and naming is available on the GUI **Sync List** tab from the default sync list for the server - see: [Set up an LDAP Server](#).

Enter a descriptive name for the cloned CFT, which will then show in the hierarchy on the drop-down list of **Sync List** CFTs that are available when you modify an LDAP server or create a new server.

10.1.5. Multiple LDAP OUs Per Hierarchy

Large corporations and institutions with multiple domains or agencies may require more than one LDAP Organizational Unit (OU) to be configured at a hierarchy.

VOSS-4-UC allows for multiple LDAP OUs at a hierarchy by providing for a *unique combination* of the following LDAP server properties at the hierarchy:

- IP address
- Port
- search base DN

Multiple search base DN's can therefore be configured at the *same hierarchy* for different organizations within the same company, so that administrators and self-service users can successfully authenticate. For example:

LDAP server setup:

IP	Port	Search base DN	Hierarchy
1.2.3.4	389	ou=SharedOUA,dc=voss-solutions,dc=com	Provider.Customer
1.2.3.4	389	ou=SharedOUB,dc=voss-solutions,dc=com	Provider.Customer

Users:

- userA: ou=SharedOUA,dc=voss-solutions,dc=com
- userB: ou=SharedOUB,dc=voss-solutions,dc=com

10.2. Set up an LDAP Server

Use this procedure to set up an LDAP server for integration with VOSS-4-UC.

Procedure

1. Log in as provider, reseller, or customer administrator.
2. Set the hierarchy node to the desired node where you want the users synchronized.
3. Choose **LDAP Management > LDAP Server**.
4. Click **Add**.
5. Complete, at minimum, the mandatory LDAP Server fields - see *LDAP Server Fields* below.
6. On the **Sync List** tab, optionally select a **LDAP Sync List Template** according to the server type. By default, the following templates are available:

- **Ldap Sync List Microsoft Active Directory**
- **Ldap Sync List Open Ldap**

The selection can optionally be modified on the **Sync List** tab *after saving* the server - see *LDAP Sync List Fields* below. If no template is selected, LDAP sync will not be affected by this list. See:

- [Set up LDAP for User Synchronization](#)
- [Synchronize Users from LDAP](#)

7. Click **Save** to save the LDAP server.

What to Do Next

Perform a test connection to ensure the LDAP server is configured correctly. If the authentication credentials or search base DN are invalid, an error message pops up on the GUI, for example:

Error encountered while processing your request

caught exception: [Helper] validation failed; Invalid search base db.

10.2.1. LDAP Server Fields

Fields	Description
Description	Defaults to the current hierarchy level.
Host Name *	Hostname or IP address of the LDAP server. This field is required.
Port	Port number for LDAP traffic. Defaults to 389.
User DN *	The User Distinguished Name of an administrative user who has access rights to the Base DN on the LDAP server. This field is required. Examples: <ul style="list-style-type: none"> • Administrator@stb.com • OU=LDAP0,DC=stb,DC=com
Admin Password *	Admin password associated with the user. This field is required.
Search Base DN *	Base Distinguished Name for LDAP search. This should be a container or directory on the LDAP server where the LDAP users exist, such as an Organization Unit or OU. As an example, to search within an Organizational Unit called CUS01 under a domain called GCLAB.COM, the Search Base DN would be OU=CUS01,DC=GCLAB,DC=COM. This field is required. Note that the search will traverse the directory tree from this point down and will include any sub OU's which have been added within the OU.
Search Filter	An RFC 2254 conformant string used to restrict the results returned by list operations on the LDAP server.
Server Type *	Choose between Microsoft Active Directory or OpenLDAP . For AD LDS (ADAM), choose Microsoft Active Directory .
AD Sync Mode *	Defaults to Direct.
Enable Write Operations	This check box is only shown for Microsoft Active Directory servers (Server Type is Microsoft Active Directory) when Encryption Method is "Use SSL Encryption (ldaps://)" (port is 636). When enabled, VOSS-4-UC user management allows for the management of users on the LDAP server (add, modify, delete).

Fields	Description
CUCM LDAP Directory Name	The name of the LDAP Directory configured on CUCM that we want this user to be considered synced from. The LDAP Directory must be configured on CUCM already. This is an optional parameter but the following should be considered: For top down sync scenario, Users will be added to CUCM as Local Users if this parameter is not set. For bottom up sync scenario, Users will not be able to log on to CUCDM if this parameter is not set.
Encryption Method	Choose between No Encryption , Use SSL Encryption (ldaps://) , or Use StartTLS Extension . <ul style="list-style-type: none"> • No Encryption - default port for LDAP is port 389 • Use SSL Encryption (ldaps://)a - uses port 636 and establishes TLS/SSL upon connecting with a client. • Use StartTLS Extension - to transition to a TLS connection after connecting on port 389
Server Root Certificate	If Trust All is Cleared, the LDAP server's SSL certificate is validated against this root certificate. If no Server Root Certificate is specified, validation is done against any existing trusted CA certificates. Use this option for custom root certificates in .pem format. See "SSO Certificate Management" for more information.
Trust All	Select this check box to disable certificate validation.
Primary Key Attribute	The attribute value used to uniquely identify and search for records on an LDAP server. For example, <code>uid</code> is the attribute when using a 389-Directory Server and <code>entryUUID</code> when using an OpenLDAP server. The attribute must be unique, should not change over time and should not be location specific. If no attribute is entered, <code>entryUUID</code> is used for an OpenLDAP server and <code>ObjectGUID</code> if the LDAP server is Microsoft Active Directory.
Authentication Scope	Hierarchical scope this server applies to: Local authentication or Full tree authentication. ¹
User sync type	Type of users that can authenticate against this server: All users or Synced users only <ul style="list-style-type: none"> • All users: All users can authenticate against this server. • Synced users only (Default): Only users synced in from LDAP can authenticate against this server.
Authentication enabled	Indicate whether the server is available for authentication. Default value is True.

Search Filter examples:

- `(telephoneNumber=919*)`: all telephone numbers starting with 919
- `(((&(OfficeLocations=RTP) | (department=Engineering) (department=Marketing)))`: office is located in RTP and department is either Engineering or Marketing
- `(&(MemberOf=cn=Admin,ou=users,dc=foo,dc=com) (!(c=US)))`: all Admins except those in the U.S.

¹ See also: *User Login Options by Authentication Method and Server Authentication Scope*.

User lookup for LDAP authentication will be restricted to the `device/ldap` model specified in the **Authentication Attribute: Model Type**. For example, if this attribute was `device/ldap/user`, then the LDAP user authentication will be restricted to `(objectClass=user)`.

10.2.2. LDAP Sync List Fields

When adding a new LDAP server or updating an existing server added prior to release 19.3.4, you can choose an **LDAP Sync List Option**.

The benefits of a Sync List is sync performance and limiting synced attributes to those of interest.

The **LDAP Sync List Option** drop down offers:

- No sync list

LDAP sync is not driven by a LDAP Sync List; all fields are imported as before release 19.3.4.

- Create sync list manually

The fields to sync can be added or modified manually. For list override precedence and other considerations, see [LDAP Sync Lists](#).

- Create sync list from template

An **LDAP Sync List Template** drop down is presented to allow a sync list to be selected from a predefined Configuration Template (CFT). VOSS-4-UC provides default Sync List Configuration Templates (CFTs) for:

- Microsoft AD servers
- Open LDAP servers

These CFTs contain LDAP attributes that are typically required to be synced with LDAP. After applying the template or if template is not used, a sync list is visible and configurable directly on a saved LDAP server **Sync List** tab.

For further details, see [LDAP Sync Lists](#).

10.3. Set up LDAP for User Synchronization

This procedure configures LDAP for user synchronization. This process synchronizes users from the configured LDAP directory into VOSS-4-UC. The users then appear at the hierarchy node at which the LDAP User Sync object exists. You can manage the users through User Management menu options (for example, move users to other hierarchies, or push to Cisco Unified Communications Manager).

Note: The LDAP Authentication Only check box is available only in VOSS-4-UC.

For LDAP server setup and authentication settings, see: [Set up an LDAP Server](#).

Perform these steps:

1. Log in as provider, reseller, or customer administrator.
2. Set the hierarchy path to the node of the LDAP server you want to synchronize users from.
3. Choose **LDAP Management > LDAP User Sync**.

4. Click **Add** and provide the following information:

Field	Description
LDAP Server*	This read-only field displays the LDAP Server you are synchronizing users from.
LDAP Authentication Only	Important: Leave the check box clear to synchronize users from LDAP. Default is Clear. When cleared, users are synchronized from the configured LDAP directory and their passwords are authenticated against the configured LDAP directory. When selected, users are not synchronized from the configured LDAP directory, but their passwords are authenticated against the LDAP directory. When selected, you can manually add users from the GUI or API, bulk load them, or synchronize them from Cisco Unified CM.
User Model Type	The User Model Type identifies which LDAP object, defined in the configured LDAP server, is used to import and authenticate users. If the LDAP server is Microsoft Active Directory, the default is <code>device/ldap/user</code> . If the LDAP server is AD LDS (ADAM), this should be set to <code>device/ldap/userProxy</code> . If the LDAP server is OpenLDAP, the default is <code>device/ldap/inetOrgPerson</code> . To identify a non-default User Model Type to use, contact the LDAP server administrator.
LDAP Authentication Attribute	The attribute used for creating an LDAP user. This value will be used for LDAP authentication against LDAP when the LDAP Authentication Only check box is selected (see above field).

User Entitlement Profile	Choose the User Entitlement Profile that specifies the devices and services to which users synchronized from the LDAP server are entitled. The chosen entitlement profile is assigned to each synchronized user. It is checked during user provisioning to ensure the user's configuration does not exceed the allowed services and devices specified in the entitlement profile.
User Role (default)*	The default role to assign to the synced user (if no other LDAP Custom Role Mappings are applicable for the synced user, then this fallback/default role will be applied). This field is mandatory.
User Move Mode	Indicates whether users are automatically moved to sites based on the filters and filter order defined in User Management > Manage Filters .
User Delete Mode	Indicates whether users are automatically deleted from VOSS-4-UC if they are deleted from the LDAP directory. If set to automatic, all subscriber resources associated with the user, such as a phone, are also deleted.
User Purge Mode	Indicates whether users are automatically deleted from VOSS-4-UC if they are purged from the LDAP device model. An administrator can remove the LDAP user from the device layer even if the user has not been removed from the LDAP directory.

5. Inspect the default mappings and modify if required, see [User Field Mapping](#).

6. Click **Save**.

An LDAP synchronization is scheduled, but is not activated by default. See [Synchronize Users from LDAP](#).

Note: A number of fields are also *always* and *not* imported by VOSS-4-UC during LDAP synchronization - see: [LDAP Integration](#)

10.4. Synchronize Users from LDAP

For VOSS-4-UC, you can synchronize users from LDAP by activating a scheduled synchronization, or by performing a manual synchronization.

Note: You cannot cancel a synchronization, and you cannot delete an LDAP server while a synchronization is in progress.

Perform these steps:

1. To activate a scheduled LDAP synchronization:
 - a. Browse to **LDAP Management > LDAP Schedule**.
 - b. Click an LDAP Schedule.
 - c. Select the **Active** check box.
 - d. Click **Save**.
2. To perform a manual LDAP synchronization, see [Synchronize or Purge LDAP Users](#).

VOSS-4-UC attempts to synchronize users from the LDAP server. It may take a few minutes for the users to show up in VOSS-4-UC.

For details on sync lists and scenarios, see [LDAP Integration](#).

Next Steps

Browse to **User Management > Users** and verify that users were synchronized from LDAP.

Ensure that you first navigate to the LDAP server hierarchy in order to see the lists on the **LDAP Users** menus.

10.5. Set up LDAP for Authentication Only

This procedure sets up LDAP to only authenticate users in VOSS-4-UC. Users may be added locally, or synced from Cisco Unified CM. Users who are LDAP synced in Cisco Unified CM and then synced into VOSS-4-UC will be LDAP authenticated by default. Users who are manually configured in Cisco Unified CM and then synced into VOSS-4-UC will not be LDAP authenticated by default. Users who are manually configured in VOSS-4-UC also will not be LDAP authenticated by default. The default behavior can be changed using the procedures described in View and Update LDAP Authentication Users.

Note: LDAP for Authentication Only is available at hierarchy nodes that have an LDAP server. Therefore, LDAP for Authentication Only is not available for users created at the site level.

Important: When **LDAP Authentication Only** is used (check box selected), then the **CUCM LDAP Directory Name** for the LDAP server must be filled in.

When more than one LDAP server sync is created and this is not filled in, no LDAP users will be created and a warning message will be seen in the transaction log.

Perform these steps:

1. Log in as provider, reseller, or customer administrator.
2. Set the hierarchy path to the node where you have set up the LDAP server you want to use to authenticate users.
3. Choose **LDAP Management > LDAP User Sync**.
4. Click **Add**.
5. On the **Base** tab, provide this information:

Field	Description
LDAP Server	Choose the LDAP Server you are authenticating users at.
LDAP Authentication Only	<p>Important: Select this check box to use the LDAP server only to authenticate users. Default = Cleared. When cleared, users are synced from the configured LDAP directory and their passwords are authenticated against the configured LDAP directory.</p> <p>When selected:</p> <ul style="list-style-type: none"> • The CUCM LDAP Directory Name for the LDAP server must be filled in. When more than one LDAP server sync is created and this is not filled in, no LDAP users will be created and a warning message will be seen in the transaction log. • Users are not synced from the configured LDAP directory, but their passwords are authenticated against the LDAP directory. • You can manually add users from the GUI or API, bulk load them, or sync them from Unified CM.
User Model Type	This read-only field identifies which LDAP object, defined in the configured LDAP server, is used to authenticate users.
LDAP Authentication Attribute	<p>Choose the LDAP Attribute to be used to authenticate users. This field is mandatory. Options are:</p> <ul style="list-style-type: none"> • sAMAccountName - AD only, this is the default for AD. • uid - OpenLDAP only, this is the default for OpenLDAP. • mail • employeeNumber • telephoneNumber • userPrincipalName - AD only. <p>These are the same values Unified CM users for LDAP Attribute for User ID.</p> <p>Caveats (AD only) For the following types of users, do not select userPrincipalName, unless the userPrincipalName value was set as the Username when the user was created:</p> <ul style="list-style-type: none"> • Users created using the VOSS-4-UC GUI • Users created using the VOSS-4-UC API • Users bulk loaded into VOSS-4-UC • Users manually created in Unified CM and synced into VOSS-4-UC <p>For users synced from LDAP into Unified CM and then into VOSS-4-UC: Caveats (AD and OpenLDAP) For users synced from LDAP into Unified CM and then into VOSS-4-UC:</p> <ul style="list-style-type: none"> • We strongly recommend selecting the same LDAP Authentication Attribute as Unified CM uses for LDAP Attribute for User ID. • If you sync users into Unified CM using attributes other than sAMAccountName/uid, do not choose sAMAccountName/uid. <p>If you sync users from LDAP into Unified CM using employeeNumber, choose employeeNumber for the LDAP Authentication Attribute. However, to get the LDAP Authentication to work properly, one of these conditions must be met:</p> <ul style="list-style-type: none"> • Before syncing users from Unified CM to VOSS-4-UC, set the Employee Number field on the CUCM Server FieldMapping tab to userid. • Define the LDAP for Authentication Only sync before syncing users from Unified CM into VOSS-4-UC

6. Click **Save**.

All users that have SyncToHierarchy set to the hierarchy of the LDAP server now use the LDAP server for authentication. The users are added to the LDAP Authentication Users list.

10.6. View and Update LDAP Authentication Users

All users that use LDAP for authentication are displayed on the **Users** form (default menu **User Management > Users**). This list includes users that use LDAP for authentication only, and users that have been synced from LDAP.

Note: To view LDAP Authentication Users only, filter the list to display **LDAP** users.

Perform the following steps:

1. Log in as provider, reseller, or customer administrator.
2. Choose **User Management > Users**.
3. Filter on the **Sync Source** column to display **LDAP** users.
4. Click **Add** to add a new LDAP user or select an existing LDAP user to update. For each user that uses LDAP for authentication the following information is displayed on the **Account Information** tab:

Field	Description
LDAP Server	The LDAP server being used for authentication.
LDAP Username	Matches the value of the LDAP authentication attribute which is specified in the User Model Type field of the LDAP User Sync configuration.

5. To disable LDAP authentication for a user, select the user and click **Delete**. LDAP Authentication for the user is removed from the Users list. Local authentication is used for the user to log in.
6. To update LDAP authentication for a user, select the user, make the updates and click **Save**. You can update only the LDAP Username field. However, LDAP authentication fails if the corresponding change is not also done on LDAP.

10.7. Set Up LDAP Custom Role Mappings

This procedure applies customized roles to LDAP synced and moved users, and overwrites the default roles that are applied following an LDAP User Sync or Move User operation.

Note: This procedure is relevant only for top-down deployments.

Important: For LDAP User Sync

- By default, users synced in from an LDAP server are assigned the role configured in the 'User Role (default)' in the LDAP User Sync.
- The role specified in the Custom Role Mapping takes precedence over the 'User Role (default)', when both of the following conditions are met:

- The user's **Active Directory Group** Membership matches a group configured in the Custom Role Mapping.
- The hierarchy of the LDAP User Sync matches the **Target Role Context**.

For Move User

- By default, users moved manually to a hierarchy (using 'Move Users') are assigned the role specified in the 'Set Default Role'.
- The role specified in the Custom Role Mapping takes precedence over the 'Set Default Role' chosen in 'Move Users', when both of the following conditions are met:
 - The user's **Active Directory Group** matches a group configured in the Custom Role Mapping.
 - The user's destination hierarchy type matches the **Target Role Context**.
- By default, a user moved to a hierarchy automatically (using a filter), is assigned the role specified in the filter in 'Set Default Role'.
- The role specified in the Custom Role Mapping takes precedence over the 'Set Default Role' set in the filter, when both of the following conditions are met:
 - The user's **Active Directory Group** Membership matches a group configured in the Custom Role Mapping.
 - The user's destination hierarchy type (specified in the filter), matches the **Target Role Context**,

Perform these steps:

1. Log in as provider or reseller administrator.
2. Set the hierarchy path to where the LDAP Custom Role Mapping must be added.
3. Choose **LDAP Management > LDAP Custom Role Mappings**.
4. Click **Add**.
5. Complete the following mandatory fields:

Field	Description
Active Directory Group*	A group in the Active Directory to which the user belongs. This is derived from the 'memberOf' from the LDAP Schema. This must be an exact match of the value defined in Active Directory, e.g. CN=Administrators,CN=Builtin,DC=test,DC=net.
Target Role Context*	This value defines the hierarchy for which the Custom Role Mapping will be applied. This must match the hierarchy type where the users are Synced, or their destination hierarchy when moved. For example, if the user is assigned a 'CustomerAdmin' role, and the LDAP User Sync is configured at Customer level then the Target Role Context must be set to Customer. If the user is assigned a 'SiteAdmin' role, and the user is being moved either manually or automatically using 'Filter to a Site', then the Target Role Context must be set to Site. Choose the hierarchy node type from the drop-down list.
Target Role*	The role which will be applied to the user if their Active Directory Group and Target Role Context are matched. This must be a valid role at the user's destination hierarchy. This can be defined at a specific role or defined as a macro, e.g. if the user is assigned a 'SiteAdmin' role then the role can be defined as the exact name of the role or defined as a macro, which allows re-use for any site name e.g. {{macro.SITENAME}}SiteAdmin.

6. Click **Save**.

10.8. Re-provision Synced LDAP Users

This procedure re-provisions users that were synchronized from an LDAP server, in particular, those users that have been updated on the LDAP server and for which these updates have not been propagated through VOSS-4-UC.

In particular, the re-sync will force an update of the selected users on all UC apps by executing an update Data Sync as well as its associated workflow.

Perform these steps:

1. Log in as a customer administrator or higher and select **User Management > Sync & Purge > LDAP Re-Provision Users**.
2. Choose the LDAP Server on which the users need to be re-synced.
3. From the LDAP Users control, add one or more users to re-sync.
4. Click **Save** to start the re-sync action.

11. Entitlement

11.1. Entitlement

VOSS-4-UC Entitlement represents the set of rules surrounding the suite of services and devices (and their number) available for particular subscribers. For instance, one customer may specify that end users may only have voice service with a maximum of two devices, one being a flavor of IP set, and the other being an analog set. Another customer may configure their end users to have both voice and voicemail services, with a maximum of ten devices limited to SIP sets. Both of these are valid rule sets intended to govern their respective users' service or device set.

Note: The entitlement functionality is optional. When adding or updating a user or subscriber, you can optionally assign an entitlement profile.

Entitlement rule sets are built from four principal VOSS-4-UC models:

- Device types
- Device groups
- Entitlement catalogs
- Entitlement profiles
- Entitlement defaults

11.1.1. Device Types

Device types represent the suite of physical devices which may be grouped into device groups for subsequent entitlement purposes. These device types should mirror the supported product types available on the Cisco Unified Communications Manager.

The device type data model is prepopulated with a snapshot of current product types; however, the provider administrator can add, as well as update or remove, additional device types, if needed.

11.1.2. Device Groups

A device group is a subset of device types. Device groups are not necessarily discrete; that is, different device groups may share specific device types.

Provider administrators can add, delete, and update device groups. Reseller and customer administrators can only view device groups.

11.1.3. Entitlement Catalogs

An entitlement catalog specifies supported device groups and available services (broad categories of functionality) for a particular hierarchy.

The following services can be selected in an entitlement catalog:

- Voice
- Voicemail
- Presence
- Extension Mobility
- Single Number Reach (SNR)
- Conferencing
- Collaboration
- Contact Center

Entitlement catalogs also define the maximum allowed number of total devices and the maximum allowed number of devices in each device group within the catalog.

If entitlement is to be used, an entitlement catalog must exist at the Provider hierarchy node. No more than one entitlement catalog may exist at any given hierarchy node. The entitlement catalog at a particular hierarchy node restricts the device groups, device counts, and services that are available to entitlement profiles at or below that node in the hierarchy. No entitlement profile may exceed the restrictions imposed by its associated entitlement catalog. Similarly, an entitlement catalog at a particular hierarchy imposes limitations on any subsequent entitlement catalogs beneath it in the hierarchy structure. No entitlement catalog created deeper in the hierarchy structure may exceed the restrictions specified in a higher entitlement catalog.

Provider administrators can add, update, and delete entitlement catalogs at their hierarchy level and below. Reseller and customer administrators can only view entitlement catalogs.

11.1.4. Entitlement Profiles

Entitlement profiles establish the set of services, device groups, and device limits to which an end user may subscribe. An entitlement profile inherits its initial settings from the first catalog above it. No entitlement profile may exceed the specifications dictated by the hierarchy-associated entitlement catalog. An entitlement profile may not exist at a particular hierarchy node unless an entitlement catalog exists at or above the entitlement profile's hierarchy node.

Unlike entitlement catalogs, there may be multiple entitlement profiles at a given hierarchy node. Each of these entitlement profiles must have a unique name within the hierarchy. Additionally, no device type may appear in more than one device group within a given entitlement profile.

Entitlement profiles can be assigned to users when syncing users from Cisco Unified Communications Manager or from LDAP, or when users are added or modified in VOSS-4-UC via Subscriber Management and User Management.

Provider administrators can add, update, and delete entitlement profiles at their hierarchy level and below. Reseller and customer administrators can only view entitlement profiles.

The table describes the available settings on the entitlement profiles screen:

Name	The name of the entitlement profile. The name must be unique within the hierarchy.
Description	A description for the entitlement profile.
Default Profile	Whether this is a default entitlement profile.
Available services	Services that may be assigned to this entitlement profile: <ul style="list-style-type: none"> • Voice • Voicemail • Presence • Extension Mobility • Single Number Reach (SNR) • Conferencing • Collaboration • Contact Center
Maximum Number of Devices	The maximum number of devices that may be assigned to this entitlement profile.
Device Groups	Add or remove device groups to this entitlement profile.

11.1.5. Entitlement Defaults

Entitlement defaults work differently depending on how a user is added to VOSS-4-UC:

- Bottom-up (UCM user sync)

This is based on the entitlement profile setting on the UCM server (publisher) the user is being synced from. The default entitlement profile is not used in this path.

- Quick Add Subscriber

This assigns the entitlement profile selected on the portal/loader by the administrator who adds the subscriber. When using QAS via the portal, it pre-populates the entitlement drop-down with the entitlement profile tagged as default.

- LDAP Top-down

Entitlement is determined by the entitlement profile setting on the LDAP User sync that is syncing the user in. The default entitlement profile is not used in this path.

- User Management/Subscriber Management Add (Admin Portal or loader)

This uses the value provided via the Admin Portal or loader. The default entitlement profile is not used in this path.

Important: When a user has an empty value for their Entitlement:

- If the user's Entitlement value is blank, and none of the Entitlement Profiles in the User's hierarchy tree have the **Default Profile** check box selected (set to true), then no Entitlement Profile is applied and no Entitlement checking is done. This means all services and all phones are available to the User.
- If the user's Entitlement value is blank, and one of the Entitlement Profiles **does** have the **Default Profile** check box selected (set to true), in the User's hierarchy tree, then the User will inherit this Entitlement Profile.
- If the **Default Profile** check box is cleared (set to false) from one Entitlement Profile and added to another Entitlement Profile, then this new Entitlement Profile will become the default Profile applied to all Users in the hierarchy below whose Entitlement Profile is blank.

11.2. Entitlement Enforcement

11.2.1. Device Groups

A user to whom an entitlement profile is applied is limited to devices in the device groups assigned in the entitlement profile. Adding a Phone to a user in Subscriber Management fails if the added Phone is not in a device group assigned to the entitlement profile applied to the user.

11.2.2. Device Limits

A user to whom an entitlement profile is applied is subject to the following device limits set in the entitlement profile:

- Total number of devices
- Total number of devices in a device group

Adding a Phone to a user in Subscriber Management fails if the total number of devices limit or the total number of devices in a device group limit is exceeded.

11.2.3. Transaction Log

The transaction log messages contain detailed information that can be used to determine what entitlement profile limitation caused an action to fail.

11.2.4. Service Levels

The table describes the impact on a user when a service is disabled in the entitlement profile applied to the user.

Note: An entitlement profile can be explicitly assigned to a user, or implicitly applied if an entitlement profile is designated as the default entitlement profile in a hierarchy node at or above the user's hierarchy node.

Service disabled	Result
	When this check box is selected, this entitlement
Default Profile	profile will be the default entitlement profile displayed in the Quick Add Subscriber Entitlement Profile drop-down.
Voice	Adding a phone to a user in Subscriber Management fails. For an existing user with a phone with this profile (where voice is disabled), the update of the user from "Subscriber Management" fails, unless the existing phones for the user are dissociated.
Voicemail	Adding Voicemail to a user in Subscriber Management fails. For an existing user with Voicemail, updates in Subscriber Management fail after an entitlement profile with Voicemail disabled is applied to the user.
Presence	Enabling Cisco Unified Communications Manager IM and Presence Service for a user in Subscriber Management fails. For an existing user with Cisco Unified Communications Manager IM and Presence Service enabled, updates in Subscriber Management fail after an entitlement profile with Presence disabled is applied to the user.
Extension Mobility	Adding Extension Mobility to a user in Subscriber Management fails. For an existing user with Extension Mobility, updates in Subscriber Management fail after an entitlement profile with Extension Mobility disabled is applied to the user.
Single Number Reach	For a new user, adding Single Number Reach in Subscriber Management fails, and for an existing user with Enable Mobility checked, adding Single Number Reach fails after an entitlement profile with Single Number Reach disabled is applied to the user.
Conferencing	Adding or assigning Conferencing feature to the subscriber fails if this field is enabled. For an existing subscriber if you enable Conferencing and an entitlement profile with Conferencing disabled is applied, the update operation fails.
Contact Center	Contact Center is not available for a new subscriber if this field is disabled. If Contact Center is enabled for an existing subscriber, and an entitlement profile with Contact Center disabled is applied, the update operation fails.

11.3. Configure and Assign Entitlement Profiles

1. Optionally, define additional device types.
2. Create device groups to define sets of device types that users may be entitled to.
3. Create entitlement catalogs to define limits on devices and services that entitlement profiles may entitle users to.
4. Create entitlement profiles to define the devices and services users are entitled to.
5. Identify the entitlement profile for users synced from Cisco Unified Communications Manager.
6. Identify the entitlement profile for users synced from LDAP.
7. Assign entitlement profiles to existing users in VOSS-4-UC.

See Also:

- Entitlement in the Core Feature Guide
- Add Device Type in the Core Feature Guide
- Create Device Group in the Core Feature Guide
- Create an Entitlement Catalog in the Core Feature Guide
- Create an Entitlement Profile in the Core Feature Guide

11.4. Add Device Type

VOSS-4-UC is prepopulated with a list of current product types. However, the provider administrator may add additional device types as needed.

To add a new device type:

1. Log in as provider administrator.
2. Choose **Entitlement > Device Types** (default).
3. Click **Add**.
4. Enter the new device type.
5. Click **Save**.

The new device type is added to the list of available device types that can be assigned to a device group.

11.5. Create Device Group

Device groups are used to limit entitlement to a defined subset of available device types.

To create a device group:

1. Log in as provider administrator.
2. Choose **Entitlement > Device Groups**.
3. Click **Add**.
4. Enter a name and optional description for the device group.
5. Choose devices from the list of available device types and move them into the selected list by clicking **Select**.
6. Click **Save**.

The device group is created and can now be used in entitlement catalogs and entitlement profiles.

11.6. Create an Entitlement Catalog

Entitlement catalogs limit the capabilities of entitlement profiles defined at hierarchy nodes at the same level or below where the entitlement catalog is defined.

Entitlement catalogs can be defined at the provider, reseller, or customer hierarchy level. Only one entitlement catalog may be defined at a given hierarchy node.

Note: The animation shows the procedure for creating both an entitlement catalog *and* an entitlement profile. An entitlement catalog must exist at or above the hierarchy level at which you want to create the entitlement profile.

To create an entitlement catalog:

1. Log in as provider administrator.
2. Set the hierarchy path to the location where you want to create the entitlement catalog.
3. Choose **Entitlement > Catalogs**.
4. Click **Add**.
5. Enter a name and optional description for the entitlement catalog.
6. Select the services check boxes to include in the entitlement catalog. The available services are Voice, Voicemail, Presence, Extension Mobility, Single Number Reach, Conferencing, Collaboration.
7. Specify the maximum number of devices allowable for the entitlement catalog.

The maximum number cannot exceed the total of the maximums for all the device groups included in the entitlement catalog.

8. Click '+' next to **Device Groups**, and from the **Device Group** drop-down, choose a Device Group to include in the entitlement catalog.
9. Specify the maximum number of devices allowed for the selected device group.

The maximum number for any device group cannot exceed the maximum number of devices for the catalog.

10. Click + to add more device groups to the entitlement catalog.
11. Click **Save**.

The entitlement catalog is created.

Next steps:

- Entitlement profiles can now be created at or below the level of the entitlement catalog (see: [Create an Entitlement Profile](#)).

11.7. Create an Entitlement Profile

Entitlement Profiles are used to define the services and devices a user is entitled to.

Assign an entitlement profile to a user when you:

- Sync the user into VOSS-4-UC from LDAP.
- Sync the user into VOSS-4-UC from Cisco Unified Communications Manager.
- Create or modify the user in VOSS-4-UC using Subscriber Management or User Management.

Note: The Maximum Number of Devices and Maximum Number of Devices in a Group are limitations for each individual user, not for all users in the system.

Prerequisites:

- Define an Entitlement Catalog at or above the hierarchy node where you create an entitlement profile (see [Create an Entitlement Catalog](#)).

The Entitlement Catalog restricts the service and devices that can be entitled in the Entitlement Profile. An Entitlement Profile can further restrict services and devices a user is entitled to. However, it cannot expand the services and devices beyond the restrictions defined in the Entitlement Catalog.

Note: The animation shows how to create an entitlement catalog *and* an entitlement profile. An entitlement catalog must exist at or above the hierarchy level at which you want to create the entitlement profile.

To create an entitlement profile:

1. Log in as provider administrator.
2. Set the hierarchy path to the location where you want to create the Entitlement Profile.
3. Choose **Entitlement > Profiles**.
4. Click **Add**.
5. On the **Profiles** screen, complete at minimum, the mandatory **Entitlement Profiles** fields.
6. Click the Plus sign (+) adjacent to **Device Groups** to add more device groups to the Entitlement Profile, if required.
7. Click **Save**.

The Entitlement Profile is defined and can be assigned to users.

11.7.1. Entitlement Profiles Field Descriptions

- [Contact Center Management](#)

Field	Description
Name *	Entitlement Profile name. This field is mandatory.
Description	An optional description of the entitlement Profile
Default Profile	Select this check box to make this Entitlement Profile the default for the hierarchy node. Any previously designated User Entitlement Profile automatically has this check box cleared.
Voice	Select this check box to entitle voice services.
Voicemail	Select this check box to entitle voicemail services.
Presence	Select this check box to entitle presence services.
Extension Mobility	Select this check box to entitle Extension Mobility services.
Single Number Reach	Select this check box to entitle Single Number Reach service.
Conferencing	Select this check box to add conferencing services to the profile.
Collaboration	Select this check box to add collaboration services to the profile.
Contact Center	Select this check box to add the Contact Center service to the profile.
Maximum Number of Devices *	Specify the maximum number of devices allowable for the Entitlement Profile. This field is mandatory. The maximum number cannot exceed the total of the maximums for the entire device group included in the Entitlement Profile.
Device Group *	Choose a Device Group to include in the Entitlement Profile. This field is mandatory.
Maximum Number of Devices in Group *	For the selected device group, specify the maximum number of devices allowed. This field is mandatory. The maximum number for any device group cannot exceed the maximum number of devices for the profile.

12. User Management

Important: For VOSS-4-UC release 21.1, refer to the *VOSS-4-UC 21.1 Release Changes and Impact* document for details on model and workflow changes. Customizations related to these changes may be affected.

The VOSS-4-UC 21.1 Release Changes and Impact PDF is available on the Documentation Portal.

12.1. Users

12.1.1. User Management Overview

There are two types of users in VOSS-4-UC:

Local administrators	Can be assigned to any of the hierarchy nodes (provider, customer, site).
End users	Can only be assigned at the site level.

Important: For VOSS-4-UC release 21.1, refer to the *VOSS-4-UC 21.1 Release Changes and Impact* PDF document on the Documentation Portal for details on model and workflow changes. Customizations related to these changes may be affected.

How Users are Added to the System

Users may be added to VOSS-4-UC from these sources:

- Synchronized from LDAP
- Synchronized from Cisco Unified Communications Manager (CUCM)
- Bulk loader template
- Manually created

Users are typically associated with a site. You can create move filters to automatically assign users to sites when they are synchronized from LDAP or Unified CM. Bulk loaded and manually created users can be moved using filters or by individually selecting users.

If an identity provider (IdP) server is deployed at a hierarchy node above the site, you can configure VOSS-4-UC to provide single sign-on (SSO) support for users created or synchronized at that hierarchy node.

Note: (Cisco only) Users associated with a site can be pushed to the Unified CM that appears in the network device list assigned to that site. Once pushed to Unified CM, users become subscribers that can be provisioned with various collaboration services.

User Sync Conflicts

Conflicts between users synchronized from different sources are handled according to the strategy described in [Managing Duplicate Usernames](#). For information about user password management, depending on the source of the user, see Password Management.

User Default Language

If a user's language is not explicitly set, the language is inherited from the nearest hierarchy node (at or above the user node) that has a default language. If no default language is set anywhere in the hierarchy at or above the user node, the language is set to English.

Related Topics

- [User Authentication Methods](#)
- [View Users](#)
- [Add an Admin User](#)
- [Update a User](#)
- [User Management Scenarios](#)
- [User Sync Source](#)
- [User Field Mapping](#)

12.1.2. Users and Subscribers

Users become subscribers in VOSS-4-UC when they're provisioned with services.

The primary purpose of a VOSS-4-UC user is to allow you to stage users into VOSS-4-UC before assigning a site and UC applications. As part of the process of assigning users with phones and/or services and configuring these in the downstream UC App, the system creates a subscriber entry for the user. Once a VOSS-4-UC user is sent to the Cisco Unified CM, a corresponding subscriber is created in the system.

The table describes the main differences between user and subscribers:

VOSS-4-UC User	<ul style="list-style-type: none"> • Exists only on VOSS-4-UC. • Represents VOSS-4-UC local data associated with a user. • Includes the user's details. • Can exist on different hierarchy levels. • Can be created independently of a user (can exist on its own). • Can be created on VOSS-4-UC directly or imported from an external source, such as LDAP. • Becomes a subscriber when it is assigned with phones and/or services. • Managed via the Users page (default menu: User Management > Users).
Subscriber	<ul style="list-style-type: none"> • Exists on the UC applications (such as Cisco Unified Communications Manager, Cisco Unity Connection, Microsoft, Avaya, WebEx). • Represents UC application data associated with a user. • Is always associated with a user since it is created once the corresponding VOSS-4-UC user is sent to a downstream UC app. • Exists only at site level on VOSS-4-UC. Therefore, before a user is provisioned with phones and/or services, it must be placed in the relevant site. • Managed via the Subscribers page (default menu: Subscriber Management > Subscribers).

Users, Subscribers, and the User Provisioning Workflow

Both users and subscribers are impacted during user provisioning operations, such as LDAP sync, Cisco Unified Communications Manager (Cisco Unified CM) sync, or user bulk loading.

A typical “top-down” approach to user provisioning progresses from LDAP, to VOSS-4-UC user, to subscriber.

1. Sync user from LDAP into VOSS-4-UC. A VOSS-4-UC user is created.
2. Move the VOSS-4-UC user to a site (default menu: **User Management > Move Users**)
3. Push the user to the UC applications. The corresponding subscriber can be created from either of the following:
 - **Subscribers** page (default menu: **Subscriber Management > Subscribers**)
 - **Quick Add Subscriber** page (default menu: **Subscriber Management > Quick Add Subscriber**).

Note: You do not need to send all VOSS-4-UC users to a Cisco Unified CM and have a corresponding subscriber created; this is the administrator's decision, based on criteria associated with each user. We

recommend that you filter out any users from LDAP that are not eligible for UC services. It is possible that some ineligible users cannot be filtered due to missing attributes and thus get synced into VOSS-4-UC. These users remain as VOSS-4-UC users (a corresponding subscriber is not created).

Additional Functionality of VOSS-4-UC User

Besides allowing you to stage users prior to sending to Cisco Unified CM, VOSS-4-UC users also allows:

LDAP sync	The workflows to manage syncing users from LDAP.
LDAP authentication	Enabling and disabling LDAP authentication.
SSO	Enabling and disabling SSO authentication.
Provisioning status	Tracking where the user comes from (LDAP, Cisco Unified CM, manual configuration), and the hierarchy the user was originally added to.
Moving users	Between hierarchy nodes.

VOSS-4-UC User and Corresponding Subscriber

All subscribers have a corresponding VOSS-4-UC user. This allows the user to sign in to VOSS-4-UC (using either local authentication, LDAP authentication, or SSO authentication), and to track the provisioning status.

You can create a subscriber directly, using either of the following:

- The Admin portal
- Bulk load
- Cisco Unified CM sync

A VOSS-4-UC user instance is created automatically. If staging is not required (such as when configuring a subscriber directly on a site, using bulk loading), the administrator does not need to add a VOSS-4-UC user explicitly (as a separate step).

Subscribers provide all of the UC application provisioning logic by distributing the user configuration to each of the UC applications, and combine most of the data associated with a user into one logical entity:

- Cisco Unified CM users
- Phones
- Lines
- Extension Mobility profiles
- Remote destinations
- Voicemail
- WebEx users

A subscriber is simply a representation of data in the UC applications. Each subscriber “comes into existence” when the Cisco Unified CM end user is created, and disappears when the Cisco Unified CM end user is deleted (either on Cisco Unified CM directly or from VOSS-4-UC). The subscriber is removed even if there are phones, lines, or profiles remaining that were previously associated with the corresponding user.

When the UC application data is created (specifically, the Cisco Unified CM End User), the subscriber is available to view in the list view. When the UC application data is deleted (in particular, the Cisco Unified CM End User), the subscriber disappears.

Unlike VOSS-4-UC users, there is no local data in VOSS-4-UC that defines the subscriber; it is all based on data in the UC applications themselves.

In the **Subscribers** list view (default menu: **Subscriber Management > Subscribers**), any user that has a Cisco Unified CM End User instance appears in the list, regardless of whether there is any other data associated with the user (such as phone or line).

Note: Any changes on the Cisco Unified CM, such as adding or deleting end users, appear in VOSS-4-UC only after a sync is performed. Refer to the “Data Sync” section of the Guide for more information on data syncing.

Since subscribers are a representation of the data in the UC applications, they may be updated either in VOSS-4-UC or in the UC applications directly.

- When updating a subscriber on the **Subscribers** page (default menu: **Subscriber Management > Subscribers**), the data on the UC application is updated immediately.
- When updating a subscriber directly in the UC applications, the changes are visible in VOSS-4-UC the next time you view the subscriber.

Related Topics

- User Provisioning Use Cases in the Core Feature Guide
- Multi-vendor Subscribers in the Core Feature Guide

12.1.3. View Users

From the default menu **User Management > Users** list view, users are shown at or below the current hierarchy node. The users can be created in the system in various ways, depending on your specific setup:

- Synced in from LDAP and promoted to a user
- Synced in from applications (for example: Voicemail, Conferencing, and so on - see: [User Sync Source](#))
- Added to VOSS-4-UC when creating an end user
- Added to VOSS-4-UC when creating an administrator user

User creation can also vary across different hierarchies in the system.

Note the following user details:

Sync Source	The source application of user data, for example: LOCAL indicates that the user has been manually created in VOSS-4-UC and has not been synced from LDAP or from Cisco Unified CM. CUCM indicates that the user exists on both VOSS-4-UC and Cisco Unified CM, and is not synced from LDAP. The user may have been created first on VOSS-4-UC (top-down) or created on Cisco Unified CM and synced into VOSS-4-UC (bottom-up). See: User Sync Source ¹
Sync Type	Identifies the user that was synced from a device as indicated by Sync Source according to a type. The setting is read-only and assists in for example distinguishing LDAP sync users (bottom-up CUCM-LDAP or or top-down LDAP). Example values: <ul style="list-style-type: none"> • CUCM-Local: if the sync source is CUCM and user is synced from CUCM • CUCM-LDAP: if the sync source is CUCM and user is LDAP synced • LDAP: if the sync source is LDAP and user is LDAP synced • LOCAL: sync source is LOCAL
User Type	Administrators (Admin) who are users accessing the system in order to perform administrative activities End users (End User) that will be set up with services in the system.
Auth Method	See: User Authentication Methods ²

- Click any user to see additional information about the user. See also: [View a User's Provisioning Status](#).
- Click **Add** to add a user manually.

12.1.4. Add an Admin User

This procedure adds an admin (administrator) user, using VOSS-4-UC.

To manually create an Admin user:

1. Log in at the hierarchy node where you want to create the Admin user.
2. Go to (default menu) **User Management > Users** to open the **Users** form.
3. Click **Add**.
4. On the tabbed pages of the Users form, fill out field values.

¹ **Sync Source**: see: [User Sync Source](#).

² **Auth Method**: see: [User Authentication Methods](#).

Note: Fill out at least the mandatory details on the form. Note that the read-only User Type field should have the value Admin. This value is defined by the role.

5. Click **Save**. The new admin user is added.

Important: Users are typically added or updated on VOSS-4-UC from the sync source, such as LDAP, CUCM, or CUC. See [User Sync Source](#) for more details.

Sync source precedence may override user input. When updating a user on VOSS-4-UC and the following conditions exist, field values are updated from the sync source and not from data input to VOSS-4-UC (in this case, the fields are read-only in the Admin Portal):

- Exists on a sync source
 - Has mapped fields
 - Has a higher precedence than LOCAL (VOSS-4-UC) data
-

Related Topics

- [User Field Mapping](#)
- [User Login Options by Authentication Method and Server Authentication Scope](#)
- [Update a User](#)

User Details Tab

Fields	Description
User Name*	Sign-in username. This field is mandatory.
Role*	Choose the user's role. This field is mandatory.
Entitlement Profile	Choose the entitlement profile that specifies which devices and services the user is entitled to.
Language	Choose the user's language. Note: If no language is selected, the language is inherited from the nearest hierarchy node (at or above the user) that has a default language configured. If no default language is configured anywhere in the hierarchy at or above the user, the user's language is English. Note: If a language is manually set for a user, that language remains unchanged even if the user is moved to a new place in the hierarchy. However, if the language is inherited, then the user's language changes when the user is moved to a hierarchy node that has a different default language.
Exclude from Directory	If this check box is selected, the user will not appear in the corporate directory accessed via VOSS-4-UC Phone Services - ¹
Sync Source	Identifies the application from which the user (and user data) was synced, i.e. LOCAL (VOSS-4-UC), CUCM or MS-LDAP. This field is read only.
User Type	Read-only. Determined by the role interface. (administration / selfservice)
Auth Method	Identifies the authentication method for the user - ² This section is <i>applicable to End Users only</i> . <ul style="list-style-type: none"> • Local - VOSS-4-UC User • Automatic - If LDAP or SSO set at hierarchy or above, use this • LDAP -³ • SSO -⁴
LDAP Server and Username	Only editable when Auth Method is LDAP
LDAP Username	Only editable when Auth Method is LDAP
SSO Identity Provider	Only editable when Auth Method is SSO
SSO Username	Only editable when Auth Method is SSO. Defaults to VOSS-4-UC username.

¹ See [Phone Services Feature Setup](#)

² See [User Authentication Methods](#)

³ See [View and Update LDAP Authentication Users](#)

⁴ See [Single Sign On \(SSO\) Overview](#)

Account Information Tab

This tab allows the administrator to manage user account information, including:

- Change Password on next Login
- Credential Policy
- Disabled (Y/N)
- Reason for Disable
- Time Locked Due to Failed Login Attempts
- Time of Last Successful Login
- Locked (Y/N)
- Security Questions
- Used Passwords

Contact Information Tab

This tab is relevant only to end users.

Defines contact information for the user, such as employee number, employee type, country, state, street, department, manager, Fax number, directory URL, Jabber ID, telephone number, mobile, and IP phone.

Provisioning Status Tab

This tab is relevant only to end users.

Provides a view showing the composition of the user, this typically includes:

- CUCM
- CUC
- VOSS User Hierarchy
- CUCM User Hierarchy
- CUC User Hierarchy
- CUCM 1 to N

Select the **Provisioned** check box to view additional CUCM's if applicable.

If the user is added to an LDAP server (see the **LDAP** section below), then the provisioning status will also show the server here next to the **LDAP** label.

Services Tab

This tab is relevant only to end users, and provides direct links to the associated user apps, such as: CUCM Subscriber, CUC User Voicemails, WebEx Teams user and CCX Agent.

Custom Tab

This tab is relevant only to end users. User defined customized strings and booleans.

LDAP Tab

If a secure Microsoft Active Directory LDAP server (port 636) is configured higher in the user hierarchy and the server has **Enable Write Operations** checked, user details can be managed on the server if it is selected from the **LDAP Server** drop down list. Only secure LDAP servers are listed. If no suitable servers have been set up, then the tab will not display any fields.

If no such Microsoft Active Directory LDAP server is configured and enabled, the tab will show a message to indicate this.

For setup server details, see: [Set up an LDAP Server](#). If the Microsoft Active Directory LDAP server is configured and the user already exists on this server, the tab will show a message to indicate this.

The **User Account Control** dropdown supports the following values: **Normal Account**, **Enabled**, **Password Not Required** and **Enabled, Password Doesn't Expire**.

Important:

- User management on the LDAP server from this tab is *not* supported if the **LDAP server** is not secure, in other words if indicated with port 389.
- When adding a user to the LDAP server for the *first* time:
 - A **Password** is required.
 - The **Action > Push To Ldap** menu must be used to add the user. The **Save** menu can then be used upon subsequent user updates on the LDAP server. (If the **Save** button is used the first time, other user details will be saved, but no LDAP user is added.)

When the LDAP user is added, the **User Details** tab will show the **Sync Source** and **Sync Type** of the user as LDAP.

For details on updating and deleting the user on the LDAP server, see: [Update a User](#).

Note:

- If SSO is enabled for the hierarchy node where the user is added, the corresponding SSO user is created.
 - IdPs are not configured at the site hierarchy node. Therefore, you can enable SSO for a user created at the site level only by performing these steps. Open the **SSO User** form (default menu **Single Sign On > SSO User**), click **Add**, and choose the IdP that can authenticate the user.
-

12.1.5. Update a User

Users are typically added or updated on VOSS-4-UC from the sync source, e.g. LDAP, CUCM, CUC, etc. See [User Sync Source](#) for more details.

Important: Sync Source precedence may override user input. If you update a user on VOSS-4-UC:

- that exists on a sync source
- has mapped fields
- has a higher precedence than LOCAL (VOSS-4-UC) data

Only the mapped fields will be updated from the sync source. The data of these fields will be updated from the sync source and not the user input added in VOSS-4-UC. The Admin Portal would typically render these fields read-only.

For user authentication method (Auth Method) changes upon updates, see [Authentication Method Setting Rules](#).

Sync Source Scenarios

- [Add User Sync Scenarios](#)
- [Update User Sync Scenarios](#)
- [LDAP Add Sync Scenarios](#)
- [LDAP Update and Delete Sync Scenarios](#)

See also [User Field Mapping](#).

Additional Info

Note: Updating an Admin user who has become a subscriber creates a sync with the application highest on the User Sync Source precedence, and according to the field mapping for that source. The sync occurs once you click **Save**.

If the Admin user password is *updated*, user passwords on Unified CM, Unity and WebEx are also updated if these have been provisioned for the user.

Note: Since different UC apps can have different password strictness rules, the update transaction will only succeed if the strictness rules of *all* the UC apps have been met. Otherwise, the update transaction will roll back.

Administrators should therefore choose a password that meets the requirements of all the UC apps.

If the user was added as a Microsoft Active Directory LDAP user (see: [Add an Admin User](#)), then:

- Additional fields on the User tabs are exposed that can be saved to the Microsoft Active Directory LDAP server.
- Updates to user details on the **LDAP** form tab will update the Microsoft Active Directory LDAP server when clicking **Save**.
- If user updates made directly on the Microsoft Active Directory LDAP server will reflect on VOSS-4-UC once the user is again synced in VOSS-4UC from the **Sync & Purge** menu.

On the button bar on the associated **Users** form, there are additional actions available to manage a user:

- **Align Hierarchy to Sync Source**

For example, if the user's sync source is 'CUCM', and the data/User is at Customer level and the CUCM user is at Site level, then the data/User instance will be moved from Customer level to the CUCM's hierarchy, i.e. Site level

- **Align Hierarchy to User**

All other related instances of the User (e.g. CUCM, device/cucm/User, device/cuc/user, etc.) will be moved to the hierarchy of the data/User instance.

- **Delete From Ldap**

If the user was also added to a Microsoft Active Directory LDAP server, (see: [Add an Admin User](#)), then the user can also be removed from the server using this menu. The user's **User Details** tab will then reset the **Sync Source** and **Sync Type** of the user according to the Sync Source precedence.

If this menu option is used for users on LDAP servers that are not Microsoft Active Directory LDAP servers on port 636 and with **Enable Write Operations** checked, the delete transaction will fail.

- **Push To Ldap**

This menu must be used when adding user details on the **LDAP** form tab for the *first time* and first adding the LDAP user - see: [Add an Admin User](#). Thereafter, the **Save** button will also update the LDAP user details on the LDAP server. However, if any user details have been updated for the LDAP server, this **Push To Ldap** menu option will also save these.

- If this menu option is used for users on LDAP servers that are not Microsoft Active Directory LDAP servers on port 636 and with **Enable Write Operations** checked, the transaction will fail with a message "Write Operations not enabled on LDAP server".
- For CUCDM-LDAP synced users, the **LDAP** tab will show a message that Push to LDAP is not allowed.

See [Add an Admin User](#)

12.2. Provisioning

12.2.1. Prerequisites

End-user provisioning with VOSS-4-UC depends on the completion of the following customer onboarding tasks:

- Devices defined (Cisco Unified Communications Manager, UC applications, WebEx)
- Network Device Lists (NDLs) created
- Single Sign On enabled, if necessary
- LDAP integration enabled, if necessary
- Any customer equipment to be monitored defined
- Customer sites defined with associated NDLs
- Directory Number Inventory configured
- Voice Mail service defined and associated with a customer

12.2.2. Sample End-user Provisioning Workflow

The following is a sample end-user provisioning workflow. Not all steps apply for all customers. Some steps can be performed in alternate order.

1. Synchronize users from the LDAP server:
 - Set up LDAP for User Synchronization
 - Synchronize Users from LDAP
2. If LDAP synchronization is not used and users are provisioned on Cisco Unified Communications Manager (Unified CM), you can synchronize users from Unified CM. For more information, see [Synchronize Users, Lines, and Phones from Cisco Unified CM](#).
3. In addition to synchronizing users, you can manually create users. For more information, see [Add an Admin User](#).
4. (Optional) You can explicitly assign a credential policy to a user. For more information, see [Assign a Credential Policy to a User](#).
5. Move users to sites using any of the following methods:
 - a. Define move filters. For more information, see [Create a Filter to Move Users](#).
 - b. Enable automatic user moves for synchronization. For more information, see [Automatically Move Users Synchronized from Cisco Unified CM](#).
 - c. Manually move users. For more information, see [Move Users](#).
6. Push manually created and LDAP-synchronized users to Unified CM. For more information, see [Manual User Add to Cisco Unified CM](#).
7. Manage subscribers (see under [Add Subscribers](#)):
 - a. Configure a Phone with a Line.
 - b. Associate a Phone to a Subscriber.
8. (Optional) Associate voice mail to a subscriber (see under [Add Subscribers](#)):
 - a. Associate the Voice Mail Service to a Subscriber.
 - b. Associate a Voice Mail Profile to a Line.
 - c. Enable Call Forward to Voice Mail.
 - d. Reset a Phone.
9. (Optional) Associate the Extension Mobility Service to a subscriber (see under: [Add Subscribers](#)):
 - a. Add Login/Logout Service on Unified CM.
 - b. Import UC Services and Service Profiles.
 - c. Subscribe the Login/Logout Service to a Phone.
 - d. Associate the Extension Mobility Service to a Subscriber.
10. (Optional) Configure conferencing (see [Conferencing: Overview](#) and [Add Subscribers](#)).
11. Configure Single Number Reach for a Subscriber (see under: [Add Subscribers](#)).
12. Associate a Service Profile to a Subscriber and Enable IM and Presence.

12.2.3. User Provisioning Use Cases

The following are two typical user provisioning use cases:

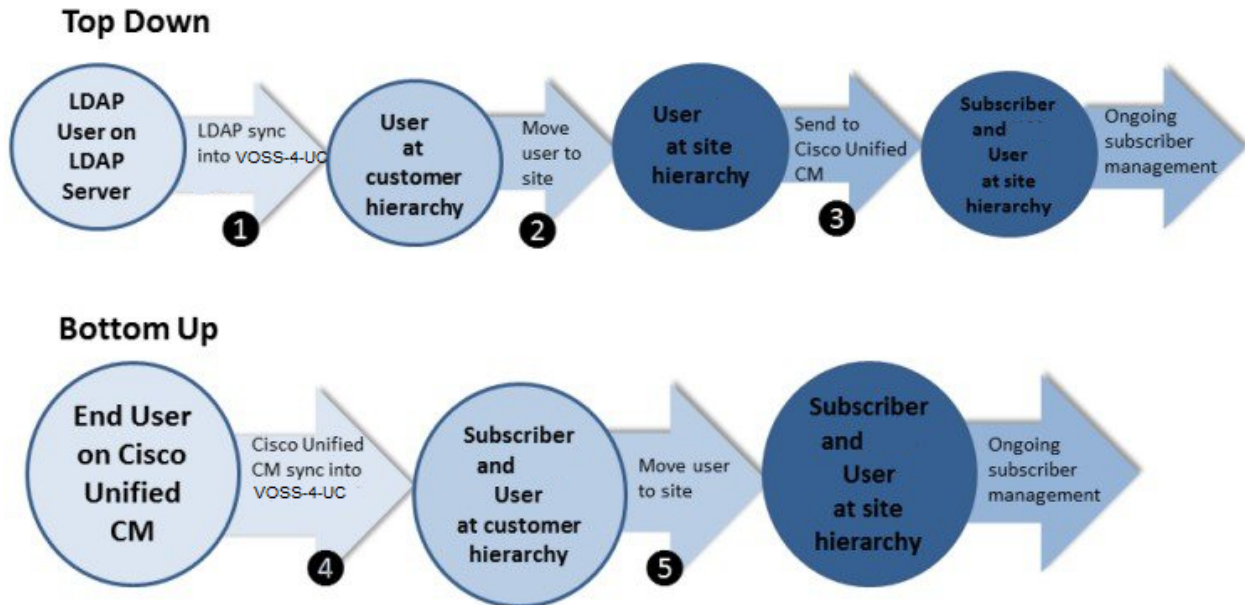

Use the following menus in VOSS-4-UC to perform the operations shown in the preceding figure:

- User Management > Sync & Purge > LDAP Users**
- User Management > Move Users**
- Performed by any of the following:
 - User Management > Users**
 - Subscriber Management > Subscribers**
 - Subscriber Management > Quick Add Subscriber**
- User Management > Sync & Purge > CUCM Users, Lines, Phones**
- User Management > Move Users**

In each diagram, the user starts on an external server, either an LDAP (for example, Open LDAP or Active Directory), or on Cisco Unified CM. When the user is synced into VOSS-4-UC, either a VOSS-4-UC User is created, or both a VOSS-4-UC User and Subscriber are created. For each step, the diagram also shows the hierarchy node where the user exists. The result in both cases is that both a Subscriber and a VOSS-4-UC User exist. From that point, the user is primarily managed from Subscriber Management.

12.2.4. View a User's Provisioning Status

To view a user's current provisioning status.

1. Log in as provider, reseller, or customer administrator.
2. Go to (default menu) **User Management > Users** to open the Users list.
3. Click on the user to open the Users[username] page.
4. Select the **Provisioning Status** tab.
5. View The information is displayed for the user as it is visible to the administrator.

The **Provisioned** check box is selected by default so that *only provisioned data* is shown. You can clear the check box to show all unprovisioned data.

Example application fields as provisioned:

Field	Description
VOSS user	User's username.
CUCM	Unified CM server to which the user is synced.
CUC	Unity Connection server to which the user is synced.
LDAP	LDAP server to which the user is synced.
WEBEX TEAMS	Webex Teams server where the user exists.
Pexip	Pexip server where the user exists.
Synced To	Hierarchy level where the user was originally synced to or created at.
VOSS User Hierarchy	User's current hierarchy node in VOSS-4-UC.
CUCM User Hierarchy	User's current hierarchy node on Unified CM.
CUC User Hierarchy	User's current hierarchy node on Unity Connection.
LDAP User Hierarchy	User's current hierarchy node on LDAP.
WEBEX TEAMS User Hierarchy	User's current hierarchy node on Webex Teams.
Pexip User Hierarchy	User's current hierarchy node on Pexip.
CUCM 1	An alternate Unified CM server to which the user is synced.

12.3. Authentication

12.3.1. User Authentication Methods

VOSS-4-UC supports the following authentication modes for accessing the system (for administrators and end users):

- Local authentication
- LDAP Authentication
- Single-Sign-on (SSO)

The user's setup determines the type of authentication required to access the system.

The table describes the **Auth Method** settings that determine the authentication method:

Auth Method	Description
Automatic	<p>The system setup determines the authentication method, for example, the presence and viability of LDAP servers, SSO IdPs, and so on. The scope, user type, and Auth Enabled settings on the server determines viability:</p> <ul style="list-style-type: none"> • If a viable IdP server is detected, authentication defaults to SSO. Since this requires using the special SSO Login URL, login from the VOSS-4-UC login page will fail. • If viable LDAP servers are found, authentication is attempted against each server until one is successful or all fail. • If neither of these external servers are found (IdP or LDAP), local authentication occurs. <p>Authentication is performed in order of preference, in the user's hierarchy, or above:</p> <ol style="list-style-type: none"> 1. Local user <i>only if</i> no LDAP, SSO IdP, in this hierarchy or above 2. LDAP server 3. SSO identity provider (IdP)
Local	<p>User authentication is based on the password defined and stored locally in VOSS-4-UC. The VOSS-4-UC credential policy is fully utilized in this method and defines the rules for the password (complexity, aging, etc), as well as further limits on session length, and so on. Local authentication can be done using username or email address. Local authentication is blocked if there are external authentication servers higher in the path. Currently these are SSO IdP and LDAP servers. If these are found and are viable authentication servers, in terms of the server's scope, user type and Authentication Enabled settings, then local authentication is bypassed.</p>
LDAP	<p>The authentication method is LDAP authentication. Additional details can be provided to tie the user to a specific LDAP server or an alternate username can match to the one in LDAP (default is the VOSS-4-UC username). When using LDAP Authentication, the password rules that are a part of the credential policy in VOSS-4-UC do not apply, since the password is managed in the LDAP directory. Other credential policy rules, such as session length, are however applied, since these are managed by VOSS-4-UC.</p>
SSO	<p>The authentication method is Single Sign-on (SSO). Additional details can be provided to tie the user to a specific SSO IdP server or alternate username can match to the one in the IdP (default is the VOSS-4-UC username). The VOSS-4-UC credential policy is irrelevant, since password rules, session length, and so on are all managed by the IdP outside of VOSS-4UC. Single Sign-on support is for authentication only. It does not use authorization capabilities that are possible via SAML to control the user's permissions <i>within</i> the application. No logout is supported when using SSO (single sign-out); that is, VOSS-4-UC will not initiate the termination of a session with the IdP (the VOSS session remains active as long as there is an active IdP session).</p>

For SSO, see also [Single Sign On \(SSO\) Overview](#).

Authentication Method Setting Rules

When adding or modifying users, the user's Authentication Method is based on the **User Default Auth Method** setting in the system Global Settings, as well as on the rules outlined in the table below:

For details on these Global Settings, refer to the "Global Settings" topic in the Advanced Configuration Guide.

Action	Auth Method Setting Rule
Add user from GUI	GUI default to Global Setting, but can be changed.
Modify user from GUI	GUI default to current user Auth Method, but can be changed.
LDAP Add user sync	Automatic
LDAP modify user sync	Leave setting as is.
Unified CM add user	Apply setting from Global Settings.
Unified CM modify user	Leave setting as is.
Quick Add Subscriber add user	Apply setting from Global Settings.
Quick Add Subscriber modify user	Leave setting as is.

12.3.2. User Login Options by Authentication Method and Server Authentication Scope

The tables below show:

- whether a user can log in (indicated by Y or N) on VOSS-4-UC given the
 - a. User's **Auth Method**
 - b. User type: all users or LDAP synced
 - c. The **Authentication Scope** of the server (there is a table for SSO and LDAP):
 - Current and below
 - Current only

IDP configured. SSO (User on IDP server and SSO Login URL used)

User Auth Method	<ul style="list-style-type: none"> • Scope: Current and below • User Type: All 	<ul style="list-style-type: none"> • Scope: Current and below • User Type: synced users 	<ul style="list-style-type: none"> • Scope: Current only • User Type: All 	<ul style="list-style-type: none"> • Scope: Current only • User Type: synced users
Local	N	Y	Y (If user not at server node)	Y
LDAP	N	Y	Y (If user at server node)	Y (If user at server node)
SSO	Y	Y (If LDAP synced user)	Y (If user at server node)	Y (If user LDAP synced at server node)
Automatic	Y	Y (If LDAP synced user)	Y (If user at server node)	Y (If user LDAP synced at server node)

LDAP configured and enabled for Authentication, no IDP(SSO)

User Auth Method	<ul style="list-style-type: none"> • Scope: Current and below • User Type: All 	<ul style="list-style-type: none"> • Scope: Current and below • User Type: synced users 	<ul style="list-style-type: none"> • Scope: Current only • User Type: All 	<ul style="list-style-type: none"> • Scope: Current only • User Type: synced users
Local	N	Y	Y (If user not at server node)	Y
LDAP	Y	Y	Y (If user at server node)	Y (If user at server node)
SSO	N	N	N	N
Automatic	Y (if synced user)	Y (if synced user)	Y (If user synced at server node)	Y (If user synced at server node)

Note: If an IDP server is in scope and authentication method is set to LDAP, authentication will be attempted against LDAP on login. If the authentication method is set to Automatic, IDP(SSO) authentication takes precedence.

12.3.3. User Authentication

When logging in to the user interfaces, the credentials of the user can be authenticated based on user credentials in:

- The internal system database
- An LDAP-based external authentication server
- A SAML-based identity management server

Administrator users are users that are able to log in to the administrator interface. Presence of an administrator interface means that a system user instance exists.

Subscribers are system users that have, and are linked to, user accounts in one or more UC applications. Subscriber management supports the management of UC application user accounts that in turn may also be configured for local, LDAP or SAML authentication.

API users are system users that connect directly to VOSS-4-UC using the API. The system controls access to its service through HTTP basic authentication.

12.3.4. Credential Policies

VOSS-4-UC helps secure user accounts by authenticating user sign-in credentials before allowing system access. Administrators can specify settings for, among other things, failed sign-in attempts, lockout durations, password reset questions, and so on. The number of questions in the Password Reset Question Pool must be equal to (or more than) the number set in the Number of Questions Asked During Password Reset field. Collectively, these rules form a credential policy, which can be applied at any hierarchy level, and determine user sign-in behavior at that specific level.

A credential policy is not mandatory at specific levels in the hierarchy. However, a default credential policy is provided at the sys.hcs level. Administrators at lower levels can copy and edit this default policy if necessary. Administrators can also save it at their own hierarchy level so that it can be applied to the associated users at that level. If the administrators at the various levels do not create a credential policy at their level, it is inherited from the closest level above them. If a Provider Administrator has defined a credential policy, but a Customer Administrator has not, the customer automatically inherits the credential policy from the Provider. A different credential policy can also be defined for each user.

For each administrator user where IP address throttling (sign-in Limiting per Source) is required, manually create and assign a credential policy. The credential policy must have IP address, and username and email throttling enabled.

The default credential policy is defined at the sys.hcs level.

Note: Credential Policies are not applicable for SSO authenticated users. For LDAP Synched users, only the session timeouts are applicable.

12.3.5. Standard Users and Login

When creating a system user that uses the standard authorization method, the password is stored in the internal system database.

Note: VOSS-4-UC uses the PBKDF2 algorithm with an SHA256 hash, a key stretching mechanism recommended by the National Institute of Standards Technology (NIST), Computer Security Resource Center (CSRC).

Login URL and Page Theme

Standard users log in at the following URL: `https://{hostname}/login`

A login page page theme can be applied to the login page during the log in process. To do this, add a suffix `?theme={theme_name}` where `{theme_name}` is an available theme.

Example: `https://{hostname}/login/?theme=default`

Username Format and Hierarchy

When logging in, the username can be entered in either of the following formats:

- `{username}@hierarchy`
- `{email address}`
- `{username}`

Important: If logging in with just `{username}`, your username must be unique at the hierarchy level, else login fails. In this case, log in using either `{username}@hierarchy` or `{email address}`. Email address must be unique in the system.

Hierarchy is in dot notation and corresponds with the hierarchy to which the user belongs. The hierarchy level is the level at which the user is created. On the login form, the hierarchy is prefixed with `sys`.

Example: `johndoe@sys.VS-OPS.VS-Corp.Chicago`

See Also:

- [Standard Users and Login](#)
- [Set the Login Page Theme and Text on the Legacy Admin Portal](#) (if a theme is applied to the login screen)

12.3.6. LDAP Users and Login

When creating a system user using the LDAP authorization method, specify the LDAP server and the LDAP username.

The LDAP username corresponds to the login Attribute Name specified in the LDAP network connection.

Login URL

LDAP users log in at the following URL: `https://{host name}/login`

LDAP Username Format

When logging in with LDAP credentials, the username is in the following format: `{user ID}[@hierarchy]`

Regardless of the login Attribute Name specified in the LDAP network connection, the user email address can be used to log in.

Note:

- @hierarchy is not required when the user ID corresponds to the user's email address.
 - {user ID} corresponds to the login attribute name (for example, email address, user principal name, sAMaccountName). The login attribute name is configured in the Authentication attribute of the LDAP device connection associated with this hierarchy.
 - The hierarchy is in dot notation and corresponds with the hierarchy to which the user belongs. The hierarchy level is the level at which the user is created.
-

12.3.7. SSO Users and Login

When creating a system user using Single Sign-On (SSO) authorization, the SSO Identity Provider (IdP) must be specified, and the SSO username.

Login URL

SSO users log in at these URLs, which point to the IdP for SSO authentication with VOSS-4-UC, and eventual redirect to the relevant interface:

- SSO Login URL: `{{"https://{host name}/sso/{Login URI}/login"}}"`

Example: `https://host.Agency1.CustomerA.com/sso/CustomerA/Agency1/login`

Note: This URL format also applies to self-service users.

These URLs are specific to the admin role, also pointing to the IdP for SSO authentication, and redirect the user to the relevant administrator interface:

- Admin Portal: `"{{https://{host name}/admin/sso/{Login URI}/login}}"`
- Business Admin Portal: `"{{https://{host name}/business-admin/sso/{Login URI}/login}}"`

Credentials

Log in using the relevant SSO identity provider (IdP) credentials.

12.4. Sync and Purge

12.4.1. Subscriber and User Synchronization: Overview

Users that have been pushed to Cisco Unified Communications Manager are synchronized between the Subscriber Management and User Management functions of VOSS-4-UC. An addition, update, or deletion of a user in one place is automatically reflected in the other.

Subscribers and Default Entitlement Profiles

New users added to VOSS-4-UC using Subscriber Management are checked for entitlement against the nearest default entitlement profile located above the site where the user is being added. If no default entitlement profile exists, the user is not restricted. If a default entitlement profile is found, and the user being added has devices or services to which the user is not entitled based on the default entitlement profile, the user add will fail.

12.4.2. User Management Scenarios

This section provides details on the actions that are carried out when a user is managed, given the absence or presence of the same user in VOSS-4-UC applications or LDAP.

Add User Sync Scenarios

The table below details add and update scenarios when a user is added that may exist on VOSS-4-UC, applications or LDAP and the *default* Sync Source precedences apply. The cases are:

- if either the user exists or does not exist on LDAP
- if either the user exists or does not exist on any application that is a sync source (APP SOURCE)

Field sync takes place according to:

- Sync Source precedence - see [User Sync Source](#).
- the User Field Mapping that applies - see: [User Field Mapping](#).

Important: Sync Source precedence may override user input. If you update a user on VOSS-4-UC:

- that exists on a sync source
- has mapped fields
- has a higher precedence than LOCAL (VOSS-4-UC) data

the data of these fields will be updated from the sync source and not the user input added in VOSS-4-UC. The Admin Portal would typically render these fields read-only.

The detailed scenarios for the operation: *adding a user* (model: `relation/User`) are:

data/ User exists	device/ ldap/ User exists	device/ <APP>/ User exists	Hierarchy	Action	User Sync Source
Y			same as user	Error: user exists	
			current	Create data/User	LOCAL
	Y		same as LDAP user	Create data/User, Update data/User, based on sync source	LDAP
		Y	same as APP user	Create data/User, Update data/User, based on sync source	APP SOURCE
	Y	Y	same as APP user	Create data/User, Update data/User, based on sync source	LDAP
	Y		below LDAP user hierarchy	Create data/User, Update data/User, based on sync source, Move LDAP user to data/User hierarchy	LDAP
		Y	below APP user hierarchy	Create data/User Update data/User based on sync source Move App user to data/User hierarchy	APP SOURCE
	Y	Y	below APP user hierarchy	Create data/User Update data/User based on sync source Move LDAP user to data/User hierarchy	LDAP
	Y		above LDAP user hierarchy	Error: Create User Log entry with mes- sage	LDAP
		Y	above APP user hierarchy	Error: Create User Log entry with mes- sage	APP SOURCE
	Y	Y	above APP user hierarchy	Error: Create User Log entry with mes- sage	LDAP

Update User Sync Scenarios

The table below details data sync sources and update actions when a user is updated and the *default* Sync Source precedences apply. The cases are:

- if either the user exists or does not exist on LDAP
- if either the user exists or does not exist on any application that is a sync source

Field sync takes place according to:

- Sync Source precedence - see [User Sync Source](#).
- the User Field Mapping that applies - see: [User Field Mapping](#).

Important: Sync Source precedence may override user input. If you update a user on VOSS-4-UC:

- that exists on a sync source
- has mapped fields
- has a higher precedence than LOCAL (VOSS-4-UC) data

the data of these fields will be updated from the sync source and not the user input added in VOSS-4-UC. The Admin Portal would typically render these fields read-only.

The detailed scenarios for the operation: *updating a user* (model: `relation/User`) are:

data/ User exists	device/ ldap/ User exists	device/ <APP>/ User exists	Hierarchy	Action	User Sync Source
Y			same as user	Update <code>data/User</code>	LOCAL
Y	Y		same as user or LDAP user	Update <code>data/User</code> Non Mapped Fields only Update <code>data/User</code> based on sync source	LDAP
Y		Y	same as user or APP user	Update <code>data/User</code> Update App/User using reverse App map	APP SOURCE
Y	Y	Y	same as any of user, APP LDAP user	Update <code>data/User</code> Non Mapped Fields only Update <code>data/User</code> based on sync source Update App/User using reverse App map	LDAP
Y	Y		below user or LDAP user	Update <code>data/User</code> Non Mapped Fields only Update <code>data/User</code> based on sync source	LDAP
Y		Y	below user or APP user	Error: Create User Log entry with message RBAC issue	APP SOURCE
Y	Y	Y	below any of user, LDAP, APP user	Error: Create User Log entry with message RBAC issue	LDAP
Y	Y		above user or LDAP user	Error: Create User Log entry with message	LDAP
Y		Y	above user or APP user	Error: Create User Log entry with message	APP SOURCE
Y	Y	Y	above any of user, LDAP, APP user	Error: Create User Log entry with message	LDAP

LDAP Add Sync Scenarios

The table below details data sync sources and update actions when an LDAP user is added and the *default* Sync Source precedences apply. The cases are:

- if either the user exists or does not exist on LDAP
- if either the user exists or does not exist on VOSS-4-UC or any application that is a sync source

Field sync takes place according to:

- Sync Source precedence - see [User Sync Source](#).
- the User Field Mapping that applies - see: [User Field Mapping](#).

Important: Sync Source precedence may override user input. If you update a user on VOSS-4-UC:

- that exists on a sync source
- has mapped fields
- has a higher precedence than LOCAL (VOSS-4-UC) data

the data of these fields will be updated from the sync source and not the user input added in VOSS-4-UC. The Admin Portal would typically render these fields read-only.

The detailed scenarios and actions for the operation: *syncing an LDAP user* (sync source is always LDAP) are:

data/ User exists	device/ ldap/ User exists	device/ <APP>/ User exists	Hierar- chy	Action
Y			same as user	Update <code>data/User</code>
				Create <code>data/User</code>
	Y		same as LDAP user	Error Create User Log entry with message Purge current LDAP user
		Y	same as APP user	Create <code>data/User</code> Update <code>data/User</code> based on sync source Update APP data based on sync source
	Y	Y	same as LDAP or APP user	Error Create User Log entry with message Purge current LDAP user
Y			below user	Update <code>data/User</code> Move LDAP user to <code>data/User</code> hierarchy
	Y		below LDAP user	Error Create User Log entry with message Purge current LDAP user
		Y	below APP user	Create <code>data/User</code> Update <code>data/User</code> based on sync source Update APP data based on sync source Move <code>data/User</code> and LDAP user to APP hierarchy
	Y	Y	below LDAP or APP user	Error Create User Log entry with message Purge current LDAP user
Y			above user	Error Create User Log entry with message Purge current LDAP user
	Y		above LDAP user	Error Create User Log entry with message Purge current LDAP user
		Y	above APP user	Create <code>data/User</code> Update <code>data/User</code> based on sync source Update APP data based on sync source
	Y	Y	above LDAP or APP user	Error Create User Log entry with message Purge current LDAP user
Y		Y	above user or APP user	Create <code>data/User</code> Update <code>data/User</code> based on sync source Update APP data based on sync source

LDAP Update and Delete Sync Scenarios

The table below details data sync sources and update actions when an LDAP user is added and the *default* Sync Source precedences apply. The cases are:

- if either the user exists or does not exist on LDAP
- if either the user exists or does not exist on VOSS-4-UC or any application that is a sync source

Field sync takes place according to:

- Sync Source precedence - see [User Sync Source](#).
- the User Field Mapping that applies - see: [User Field Mapping](#).

Important: Sync Source precedence may override user input. If you update a user on VOSS-4-UC:

- that exists on a sync source
- has mapped fields
- has a higher precedence than LOCAL (VOSS-4-UC) data

the data of these fields will be updated from the sync source and not the user input added in VOSS-4-UC. The Admin Portal would typically render these fields read-only.

The detailed scenarios and actions for the operation: *deleting an LDAP sync* - manually (M) or automatically (A) - are:

Operation	data/ User exists	device/ ldap/ User exists	device/ <APP>/ User exists	Action	User Sync Source
LDAP DELETE SYNC (M)	Y	Y		Update <i>data/User</i>	LO- CAL
LDAP DELETE SYNC (M)		Y			
LDAP DELETE SYNC (M)	Y	Y	Y	Update <i>data/User</i> based on sync source Update APP data based on sync source Convert CUCM user to local user	LO- CAL
LDAP DELETE SYNC (A)	Y	Y		Delete <i>data/User</i>	
LDAP DELETE SYNC (A)		Y			
LDAP DELETE SYNC (A)	Y	Y	Y	Delete <i>data/User source</i> Delete <i>relation/Subscriber</i>	

The detailed scenarios and actions for the operation: *updating an LDAP sync* (sync source is always LDAP) are:

data/ User exists	device/ldap/ User exists	device/<APP>/ User exists	Action
Y	Y		Update data/User
	Y		Create data/User
Y	Y	Y	Update data/User based on sync source Update APP data based on sync source

12.4.3. User Sync Source

VOSS-4-UC provides a precedence hierarchy of applications from which to sync user data.

For example:

If CCX data is synced, it will not overwrite user data synced from CUCM or CUC.

Note: Data overwrite will take place according to the relevant mapping table that exists between VOSS-4-UC data application data.

Default precedence order:

Application	Precedence
MS_LDAP	1
OPEN_LDAP	1
CUCM	2
CUC	3
AVAYA_SYSTEM_MANAGER	3
HCMF	10
CCX	10
BROADWORKS	10
MICROSOFT	10
WEBEX_TEAMS	10
ZOOM	10
LOCAL	99

Choose **User Sync Source** to see the default application precedence. The **Precedence** column shows the priority of data per application.

Related Topics

- [Add User Sync Scenarios](#)
- [Update User Sync Scenarios](#)
- [LDAP Add Sync Scenarios](#)
- [LDAP Update and Delete Sync Scenarios](#)

12.4.4. User Field Mapping

Choose the **User Field Mapping** menu to see the list of mappings at a hierarchy.

VOSS-4-UC provides a set of default (name is `default`) field mappings between applications and VOSS-4-UC user data at the `sys` level hierarchy. These mappings are used to align data during sync operations.

Whenever an application is added at a hierarchy, the default application mapping is cloned to this hierarchy level and provided with an application name (e.g. IP address for Unified CM, business key for LDAP server). This cloned mapping shows in the User Field Mapping list and applies to user management at this hierarchy.

Important: While many fields in the hierarchy-specific field mapping can be edited, care should be taken when modifying these mappings. A change will only apply to the management of *new* users, in other words existing user data at this hierarchy will not be affected by these mapping changes.

Data alignment means that the mapping that applies at the sync hierarchy for an application which is the sync source will be used when values are written to VOSS-4-UC user data. The mapping is stored in the `data/UserFieldMapping` model.

The applications are:

Application Name	Model Type
CUC	<code>device/cuc/User</code>
CUCM	<code>device/cucm/User</code>
HCMF	<code>device/hcmf/User</code>
LOCAL	<code>data/User</code>
MS_LDAP	<code>device/ldap/user</code>
OPEN_LDAP	<code>device/ldap/InetOrgPerson</code>
CCX	<code>device/uccx/Agent</code>
WEBEX_TEAMS	<code>device/spark/User</code>

For example, the default CUCM mapping contains the mapping:

VOSS-4-UC	CUCM
User Name	<code>userid</code>

Upon a sync of user data from a Unified CM source, where this default CUCM mapping applies at the hierarchy, the sync will update the VOSS-4-UC user on the list available from the **Users** menu. The user's **Sync Source** value shows as `CUCM`.

Important: If application users related to a custom field mapping exist in VOSS-4-UC, the fields that are already mapped cannot be modified. The fields are marked read-only on the interface.

In addition, 10 customizable of values of the following types are available that can also be mapped:

- Custom String
- Custom List of Strings
- Custom Boolean

After the sync, the custom values are then shown on the **Custom** tab of an entry on the **User** menu.

LDAP Mappings

- LDAP Username
 - For Microsoft Active Directory, this is typically the `sAMAccountName`.
 - For AD LDS (ADAM), the `sAMAccountName` attribute is not part of the default schema, but can be added if required. Confirm with the LDAP server administrator. Alternatively, use `uid`.
 - For OpenLDAP, this is typically the `uid`.
- Sn (Surname)

12.4.5. Users Synchronized from LDAP to VOSS-4-UC

When users are synchronized top-down from LDAP into VOSS-4-UC, LDAP authentication is enabled by default in VOSS-4-UC for these users. When LDAP users are pushed to Unified CM and Cisco Unity Connection, authentication is either LDAP or local authentication, depending on how the applications are configured. If LDAP authentication is not configured in Unified CM or Cisco Unity Connection, the user is considered to be a local user in UC applications.

12.4.6. User Synchronized from LDAP to VOSS-4-UC (SSO Enabled)

Passwords are defined and enforced at the Identity Provider when the user is synchronized from LDAP to VOSS-4-UC with SSO enabled.

12.4.7. Users Synchronized from LDAP to Cisco Unified Communications Manager

When a user is synchronized from LDAP to Cisco Unified Communications Manager (Unified CM), the password is not synchronized like other user information that is pulled from LDAP. If LDAP Authentication is enabled, the password in the LDAP Server is used unless the password was changed locally in Unified CM, forcing the Unified CM password to be used. However, if LDAP Authentication is not enabled, the default password is whatever was configured in Unified CM as the default. If no default password is defined, then configure a password manually.

12.4.8. Users Synchronized to VOSS-4-UC

Passwords are not transferred when users are synchronized from Cisco Unified Communications Manager (Unified CM) to VOSS-4-UC. An administrator must configure the passwords before the accounts can be used.

The following Unified CM users are affected: users that were manually added to Unified CM and users that were synchronized from LDAP.

12.4.9. Synchronize or Purge LDAP Users

This procedure synchronizes or deletes (purges) users that were synchronized from an LDAP server.

1. Set the hierarchy path to the hierarchy node where the LDAP server is.
2. Go to (default menu) **User Management > Sync & Purge > LDAP Users**.
3. Complete the following fields:

Field	Description
Remove Log Messages	Select the check box if you want to remove user management logs before synchronizing or purging.
Remove Log Direction	Choose Local to remove logs at the hierarchy of the LDAP server. Choose Down to remove logs at and below the hierarchy of the LDAP server. This field appears only if the Remove Log Messages check box is selected.
LDAP Server *	Choose the Organization Unit of the LDAP Server from which you need to sync or purge the users. This is mandatory field.
LDAP Action *	Choose synchronize or purge. This field is mandatory.

4. Click **Save** to start the action you selected.

12.4.10. Synchronize Users, Lines, and Phones from Cisco Unified CM

This procedure synchronizes users, lines, and phones from Cisco Unified Communications Manager (Unified CM).

Note: Synchronizing lines and phones is meant only for self-provisioning and is not intended for a full migration scenario. Only Jabber and desk phones are supported for synchronizing from Unified CM. Single Number Reach and Extension Mobility are not supported in terms of adding to Unified CM first and then synchronizing into VOSS-4-UC.

Use MIF filter to detect the unsynchronized users, and purge them from the affected site. After the users are purged, import the Unified CM once again.

1. Set the hierarchy path to the hierarchy node where the Unified CM server is.
2. Go to (default menu) **User Management > Sync & Purge > CUCM Users, Lines, and Phones**.
3. Complete the following fields.

Field	Description
Remove Log Messages	Select this check box if you want to remove user management logs before synchronizing.
Remove Log Direction	Choose Local to remove logs at the hierarchy of the selected Unified CM. Select Down to remove logs at and below the hierarchy of the selected Unified CM. This field appears only if the Remove Log Messages check box is selected.
Action	Choose synchronize. This field is mandatory.
Cisco Unified CM	Choose the Unified CM server. Data is synchronized from the selected Unified CM. This field is mandatory.

4. Click **Save** to start synchronizing.

12.4.11. LDAP Sync Actions

LDAP Sync Action enables you to perform bulk syncing for users from multiple Organization Units (OU) of any LDAP server.

Note: It also allows you to select the required OUs of a single LDAP server, and perform the users sync only from the selected OUs.

1. Log in as a provider, reseller, or customer administrator.
2. Choose **Device Management > Advanced > LDAP Sync Actions**.
3. Choose the required sync action from **Action** drop-down list.
 - Choose **Import** for bulk syncing of users from multiple Organization Units.
 - Choose **EnableScheduleSync** to enable syncing for already LDAP scheduled job.
 - Choose **DisableScheduleSync** to disable syncing for already LDAP scheduled job.
4. Choose the required LDAP Server from the **Available** area, and click **Select**. The selected LDAP Server appears in the **Selected** area.
5. Click **Save**.
6. Click **Move Up** or **Move Down** to alter the order of user syncing action for LDAP Server.

12.5. Manage Filters

12.5.1. Create a Filter to Move Users

This procedure creates a filter that will allow you to select multiple users, based on one or more user attributes, so that you can use the filter to move these users to a different hierarchy.

Note: Users moved with the filter must match all attributes in the filter, for example, a filter with State=Missouri and City=Kansas City, does not match a user in Kansas City, Kansas.

Filters are automatically applied during LDAP and Cisco Unified Communications Manager user synchronization, if the User Move mode is set to automatic.

To define the filter:

1. Go to (default menu) **User Management > Manage Filters > Define Filters**.
2. Click **Add**.
3. On each tab, locate user attributes for the filter: **Base**, **Extended**, or **Custom**

Provide the following information:

Field	Description
Name	Mandatory. Enter a name for the filter.
Move To Hierarchy	Choose the target hierarchy node. This field is mandatory.
Move To Role	Choose the role to be assigned to the user after the move. The available roles depend on the target hierarchy node selected. This field is mandatory.
Condition	Choose a condition for at least one of the available filters.
Value	Specify the value to evaluate for the condition. Set this field for at least one of the available filters.

Example: Set the City Filter to Condition=isexactly and Value=Toronto to move users in Toronto to the target hierarchy node and give them the target user role.

4. Click **Save**.

You can use the filter to manually move users using the **Move Users** form (default menu **User Management > Move Users**).

12.6. Move Users

12.6.1. Methods for Pushing Users to Cisco Unified CM

When you manage users in VOSS-4-UC, you perform several steps to process the new users introduced into the system from the following sources:

- Synchronization from the LDAP directory
- Synchronization from Cisco Unified Communications Manager
- Manual configuration in VOSS-4-UC

One step is to push the user to the Unified CM assigned to the customer and site where the user was added. You can push the user to Unified CM from VOSS-4-UC in two ways:

- Automatic Push - Enabled or disabled using the **Auto Push to CUCM** check box from **Site Management > Sites**
- Manual Push - Performed for the same user from **User Management > Users** and for example **Subscriber Management > Quick Add Subscriber**.

There are various options available in VOSS-4-UC for configuring users with phones, lines, and features. Depending on the option you choose, you can automatically push users to Unified CM.

To determine whether to automatically push users to Unified CM, consider the following guidelines:

- When users are synchronized into VOSS-4-UC from an LDAP server, or the users are configured locally on VOSS-4-UC, and then the **Subscriber Management > Subscribers** menu is used to provision phones, lines, and features for those users, we recommend an automatic user push to Unified CM. It does not matter whether you perform the Subscribers configuration through the Admin Portal, bulk loaders, or API. We recommend automatic user push to Unified CM in all cases.
- When users are configured locally on Unified CM and synchronized into VOSS-4-UC, the users are already on Unified CM, so automatic push to Unified CM is not required.

Automatic User Push to Cisco Unified CM

You can enable Automatic User Push to Cisco Unified Communications Manager by selecting the **Auto Push Users to CUCM** check box on the **Site Management > Sites > Site Details** page. Automatic User Push is cleared (disabled) by default.

Users are automatically pushed to a Unified CM in the following situations:

- When users are moved to a site hierarchy level (either by filters, username, or usernames):
 - If a Network Device List (NDL) is configured on that site and contains a Unified CM, the users are pushed to the Unified CM.
 - If an NDL is configured on that site with no Unified CM, nothing happens.
 - If an NDL is not configured on that site, nothing happens.
- When an NDL is added to a site after the site was created:
 - If the NDL is configured with a Unified CM, the users at the associated site are pushed.
 - If the NDL is not configured with a Unified CM, nothing happens.
- When a Unified CM is added to an NDL:

If the NDL is associated with a site, the users on that site are pushed to the new Unified CM.
- When a new user is created at the site level:
 - If an NDL is configured on that site and contains a Unified CM, the user is pushed to the Unified CM.
 - If an NDL is configured on that site with no Unified CM, nothing happens.
 - If an NDL is not configured on that site, nothing happens.

Manual User Add to Cisco Unified CM

You can manually add users to Cisco Unified Communications Manager (Unified CM) from hierarchy nodes between customer and site, inclusive.

See: [Quick Add Subscriber: Overview](#).

Choose **Subscriber Management > Subscriber** to verify that users are available as subscribers with assigned phones, lines, and features.

12.6.2. Automatically Move Users Synchronized from Cisco Unified CM

Use this procedure to automatically move users that were synchronized from Cisco Unified Communications Manager, using previously defined move filters.

Perform these steps:

1. Choose **Apps Management > CUCM > Servers**.
2. Click the Cisco Unified Communications Manager server to modify.
3. Click the **Publisher** tab.
4. From the **User Move Mode** drop-down, choose **Automatic**.
5. Click **Save**.

The users are automatically moved based on the previously defined move filters.+

12.6.3. Move Users

You can move users between any hierarchy nodes at or below the hierarchy node where the users were originally created or synced in. A common practice is to move users synced in at a customer hierarchy node to various customer sites.

Note: The following restrictions exist when moving users that have been pushed to Cisco Unified Communications Manager:

- Cisco Unified Communications Manager users can be moved only down the hierarchy.
- An NDL containing the same Cisco Unified Communications Manager that the users were pushed to must be referenced at or below the target hierarchy node.

Important: Site-to-Site user move is not supported in the Enterprise product, and will fail with dialplan errors.

You can choose the users to be moved in the following three ways:

- **Move users by filters** - To choose the users depending on one or more user attributes, for example City or Street
- **Move users by usernames** - To choose multiple users by their usernames
- **Move user by username** - To move an individual user

When you move users, choose a **Move To Role** from the drop-down for the users that is appropriate for the target hierarchy node.

12.6.4. Moving Users from Customer to Site

Use this procedure to move users from Customer to Site.

When you move users, choose a default role for the users that is appropriate for the target hierarchy node.

1. Log in at the appropriate hierarchy level.
2. Choose **User Management > Move Users**, or **Overbuild > Move Users**.
3. In the **Action** drop-down, choose the move method.
 - If you choose **Move users by filters**:
 - a. From the **Move From Hierarchy** drop-down, choose the hierarchy node from which you are moving the user.

A note appears stating that only users at the hierarchy you chose will be moved.
 - b. From the **Available** list, choose one or more Move Filters and click **Select** to move them to the **Selected** list. You can choose filters in a different order to change the order in which they are applied.
 - c. Click **Save** to move the filtered users.
 - If you choose **Move users by usernames**:
 - a. From the **Move From Hierarchy** drop-down, choose the hierarchy node from which you are moving the users. The **Move To Hierarchy** drop-down appears.
 - b. From the **Move To Hierarchy** drop-down, choose the target hierarchy node. The **Move To Role** drop-down appears.
 - c. From the **Set Default Role** drop-down, choose the default role for the moved users. This default role will be assigned to the moved users unless valid LDAP Custom Role Mappings have been configured, which take precedence over the default role (see: [Set Up LDAP Custom Role Mappings](#)).
 - d. Click **Users +**, and from the drop-down, choose the user to move, repeat for each user you want to move. Alternatively select the **Move All Users** check box to select all the users.
 - e. Click **Save** to move the users.
 - If you choose **Move user by username**:
 - a. From the **User** drop-down, choose the user to move. The **Move From Hierarchy** drop-down appears displaying the existing hierarchy.
 - b. From the **Move To Hierarchy** drop-down, choose the target hierarchy node. The **Set Default Role** drop-down appears.
 - c. From the **Set Default Role** drop-down, choose the default role to assign to the moved user. This default role will be assigned to the moved users unless valid LDAP Custom Role Mappings have been configured, which take precedence over the default role (see: [Set Up LDAP Custom Role Mappings](#)).
 - d. Click **Save** to move the user.
4. Choose **User Management > Users** to verify that the users are moved to the target hierarchy.

12.6.5. Purge a Cisco Unified CM User from VOSS-4-UC Only

This procedure purges a single Unified CM user from the VOSS-4-UC database only, while leaving it on the associated Unified CM.

Note: If the same user is synced from multiple Unified CMs, it results in a duplicate user on VOSS-4-UC.

1. Log in as provider administrator or higher.
2. Set the hierarchy path to the hierarchy node where the Unified CM server is.
3. Go to (default menu) **User Management > Sync & Purge > Local-Purge CUCM User**.
4. Complete the following fields.

Field	Description
Cisco Unified CM	Choose the Cisco Unified CM from which the user was synced.
User Name	From the User Name drop-down list, choose the user you want to delete from VOSS-4-UC.

5. Click **Save** to purge the selected user from VOSS-4-UC.

Note: The user remains on the associated Unified CM.

12.6.6. Site-to-Site User Move Transaction Log Errors

Transaction log errors occur with a site-to-site user move, if the following conditions are not met:

- Each site is not in the same country.
- The target site data/SiteDefaultsDoc contains the needed default settings (that is, they are not empty or null).
- Move is not outside the sync_to_hn.
- Role is valid at move to site.
- UC applications resources are set to false.

Review the transaction log for error messages and actions to resolve the errors.

12.6.7. Convert User Type CUCM-LDAP to CUCM Local

This tool is used to convert a CUCM-LDAP user account to a CUCM Local User. If the user exists on CUCxn Server then the user is also converted to a Local User, that is, the user on CUCxn is set to “Do not Integrate with LDAP Directory”.

Converting a user from CUCM-LDAP to CUCM Local is typically required when the user has been deleted from the LDAP Server, the Unified CM has synced with the LDAP Server, and the user has been set to “Inactive”. In this scenario, the user would be deleted when the Garbage Collection process runs on the Unified CM.

Converting the user to a CUCM Local user prevents the user from being automatically deleted.

- Only users with CUCM-LDAP type are shown by default in the **User to Convert** drop-down.
- If the **Show Inactive LDAP Users Only** check box is selected, the list of users is filtered to only show the “CUCM-LDAP” users with a status of “Inactive”, i.e. status value = 2.

An Inactive User on CUCM is a user that was deleted from the LDAP Server, and CUCM synced with the LDAP server after the deletion took place. Inactive Users will be deleted from CUCM when the Garbage Collector next runs on CUCM.

- Password. The password entered here will be used to set the password for the user on CUCM and CUCxn.

Informational fields show:

- Current User Hierarchy
- LDAP Directory Name
- Current User Status:
 - Active (1): the user is still in LDAP since the last sync
 - Inactive (2): the user is not in LDAP since the last sync

12.6.8. Managing Duplicate Usernames

Important: The username must be unique within the hierarchy both upwards and downwards. User email must be unique system-wide.

Users are created in a synchronization with LDAP or Cisco Unified CM, or they are created manually in the VOSS-4-UC. All users are created according to these duplicate username guidelines:

- The username of a user cannot be updated if another user in the current hierarchy has the same username. This restriction includes above, below, or at the same level in the current hierarchy.
- A user cannot be added if another user that is above, or was originally above before being moved, in the current hierarchy has the same username.
- A user cannot be manually added if another user that is at the same level or below in the current hierarchy has the same username.
- You cannot convert a user to a Subscriber / Unified CM user if another user at the same level or below the Unified CM in the current hierarchy has the same username.
- A user may or may not be synchronized from LDAP or Unified CM if another user at the same level or below in the current hierarchy has the same username. This condition depends on the source of the existing user as shown in these tables:

Note: The restriction on unique usernames in a hierarchy also applies to administrator users.

Users Created in an LDAP Synchronization

Original source of the existing user	Action
LDAP	Simple user update, if the user is coming from the same LDAP server
Cisco Unified CM	Update user, update provisioning status with LDAP server and SyncTo info
Manually created	Update user, update provisioning status with LDAP server and SyncTo info

Users Created in a Cisco Unified CM Synchronization

Original source of the existing user	Action
LDAP	User is not synchronized
Cisco Unified CM	Simple user update, if the user is coming from the same Cisco Unified CM server
Manually created	Update user, update provisioning status and SyncTo info with Unified CM server

The table below refers to Subscribers created in VOSS-4-UC using:

- Subscriber Management > Subscribers
- Subscriber Management > Quick Add Subscriber
- Auto Push feature on Site

Quick Add Subscriber and Subscriber Management create Subscribers and users, while Manage Users and the Auto Push feature convert existing users into Subscribers.

Users Created in VOSS-4-UC and Pushed to Cisco Unified CM

Original source of the existing user	Action
LDAP	Update user, update provisioning status with Unified CM server (keep SyncTo info the same)
Cisco Unified CM	No action or updates are necessary
Manually created	Update user, update provisioning status with Unified CM server and update SyncTo to the Cisco Unified CM hierarchy if the current SyncTo is below it

Note:

- If a user cannot be created or updated during an LDAP or Unified CM synchronization, a log is created in User Management > Log Messages and the synchronization succeeds. If a user cannot be created or updated manually, an error message is generated.

- If the duplicate user check fails, the transaction fails, and the user is not converted to a Subscriber.
- If a user's SyncTo value is updated, SSO User updates can result. The SSO User's IDP is set to the IDP configured at the new SyncTo hierarchy node. If no IDP is configured at the new SyncTo hierarchy node, the SSO User is deleted, if it existed. If an IDP is configured at the new SyncTo hierarchy node, but no SSO User exists, an SSO User is created at the user's hierarchy node.
- An update is blocked if two duplicate users are from the same source but originate from different servers.

12.7. Admins

12.7.1. Manage Local Administrators and Operators

This procedure adds administrators for intermediate nodes, and adds or edits local administrators or operators.

Note: Default local VOSS-4-UC administrators are created when provider, reseller, customer, and site hierarchy nodes are established.

An administrator for a particular hierarchy level can create or modify the administrators and operators at that hierarchy level and any level below. For example, a Customer XYZ administrator can create other Customer XYZ administrators and site administrators for Customer XYZ.

1. Log in as an administrator.
2. Set the hierarchy path:
 - To add or edit an administrator or operator at a level below your current level, set the hierarchy path at the top of the window.
 - If you have signed in as provider administrator and want to create a customer administrator, set the hierarchy path to the customer for which you want to create the administrator.
3. Go to (default menu) **User Management > Admins** to open the **Admins** list.
4. To edit an existing administrator or operator:
 - Click on the relevant user to open the Users[username] form.
 - Make the changes you require.
 - Save your changes.
3. To add a new administrator or operator:
 - Click the plus icon (+) to open the Users/New Record form.
 - Fill out the field values. Mandatory fields are indicated with an asterisk (*):

Field	Description
Username	Sign-in username. This field is mandatory.
Email Address	User email address.
Role	Choose the administrator's role. This field is mandatory. <ul style="list-style-type: none"> For a provider, reseller, customer, or site administrator or operator, the available roles are limited to those applicable to the hierarchy level. For an intermediate node administrator or operator, the available roles are limited to those associated with the nearest non-intermediate node above the intermediate node in the hierarchy.
Password	Set the password. This field is mandatory.
Language	Choose the administrator's language. Note: If no language is chosen, the language is inherited from the nearest hierarchy node (at or above the administrator) that has a default language configured. If no default language is configured anywhere in the hierarchy at or above the administrator, the administrator's language is English.
Sync Source	This is set LOCAL when the administrator is created on VOSS-4-UC.
User Type	Cannot be edited - determined by the Role interface (administration / selfservice).

5. Click **Save**.

12.8. Session Timeouts

12.8.1. Session Timeout Rules

The following rules apply to the idle session timeout and absolute session timeout values that can be applied to users via a credential policy:

- Setting the absolute session timeout to 0 disables it.
- The absolute session timeout takes priority over the idle session timeout. Therefore, setting the absolute session timeout to a value less than the idle session timeout effectively disables the idle session timeout.
- Credential policy session timeouts do not apply to SSO authenticated users. For SSO authenticated users, VOSS-4-UC honors the SessionNotOnOrAfter SAML 2.0 attribute, which is equivalent to an absolute session timeout, although controlled by the IDP.

Note: Timeout limits will initiate the display of timeout limit notifications in the Admin Portal - see: [Timeout Limit Notifications](#).

12.8.2. Timeout Limit Notifications

Timeout Limit Notifications are displayed in accordance with the Credential Policy that is associated with a user. See: *Customized Credential Policy* and *Session Timeout Rules*.

From 60 seconds before the session limit, in other words before a session expires, a warning message “Session will expire in [n] seconds” will show in the Admin Portal and will count down.

If the idle session limit generated the message (and the idle session limit is set to less than the absolute session limit), the user has the option to click the **Stay Logged In** button to extend the session. If the absolute session timeout is about to be reached, the user has the option to click the **Log Out Now** button to return to the login screen or to click **OK** to dismiss the message and finalize work before logout. All transactions submitted after clicking **OK** will be processed.

If the user does not click a button on the warning message box, the user is logged out and the Admin Portal returns to the login screen.

SSO users see the message:

“Your Single sign-on session will expire in [n] seconds. All transactions submitted after clicking **OK** will be processed. When the session expires, you will be automatically redirected to the log-in page.”

For the Admin Portal theme modification of the notification, refer to the Advanced Configuration Guide.

12.9. User Accounts and Passwords

12.9.1. Password Management: Overview

The following sections describe the various ways passwords are set by default and can be configured between LDAP, Voss-4-UC and Cisco Unified Communications Manager.

12.9.2. Passwords and Manually Added Users

User Added Manually Through Subscriber Management

A user added through Subscriber Management has the same password that was configured in VOSS-4-UC when the subscriber was provisioned.

User Added Manually Through User Management

A user added through User Management has the local VOSS-4-UC password that was specified when the user was created. When this type of user is pushed to Cisco Unified Communications Manager (Unified CM), the password is not pushed. Instead the password can be configured in one of the following ways:

- Create a default password with Unified CM
- Set the password in the CUCM end user page

Create a Default Password with Unified CM

1. Log in to Unified CM as an administrator.
2. Choose **User Management > User Settings > Credential Policy Default**.
3. Choose the line item that has the Credential User to 'End User' and Credential Type to 'Password'.
4. Enter the default password in the confirmation box and click **Save**.

Note: Ensure that the user has the correct role defined.

Set the Password in the CUCM End User Page

1. Log in to Unified CM as an administrator.
2. Choose **User Management > End User**.
3. Filter for the user you wish to modify.
4. Change password fields for the specified user.

12.9.3. Force User Password Change

You can use a credential policy to force users to change their passwords on initial login. However, an administrator can manually force a user password change on the next login attempt.

To manually force a password change:

1. Log in as provider, reseller, or customer administrator.
2. Choose **User Management > Users**.
3. Click the user whose password you want to be changed on the next login attempt.
4. Click the **Account Information** tab.
5. Select the **Change Password on Next Login** check box.
6. Click **Save**.

The next time the user attempts to log in, they are prompted to change their password. Once the password is changed the **Change Password on Next Login** check box is cleared.

12.9.4. Force Administrator Password Change

You can use a credential policy to force administrators to change their passwords on initial login. However, an administrator at a higher hierarchy level can manually force an administrator to change password on the next login attempt.

To manually force an administrator to change their password:

1. Log in as provider, reseller, or customer administrator.
2. Choose **User Management > Admins**.
3. Click the administrator whose password you want to be changed on the next login attempt.

4. Click the **Account Information** tab.
5. Select the **Change Password on Next Login** check box.
6. Click **Save**.

The next time the administrator attempts to log in, they are prompted to change their password. Once the password is changed the **Change Password on Next Login** check box is cleared.

12.9.5. Manage Your Own Account Password

Logged in users or administrators can manage their own account passwords.

Note:

Users who are configured for Single Sign On or through LDAP do not manage their account passwords in VOSS-4-UC.

12.9.6. Change Your Own Password

Change your own password if required as follows:

1. Log in to VOSS-4-UC.
2. Click the arrow next to the logged in user at the top right-hand side of the screen.
3. Choose the **Change Password** option from the drop-down menu. The **Change Password** screen is displayed.
4. Enter your existing password in the **Old Password** field.
5. Enter your new password in the **New Password** field. Refer to **Minimum Password Length** and **Enable Password Complexity Validation** fields under *Customized Credential Policy* if required.
6. Confirm your new password by re-entering it in the **Repeat New Password** field.
7. Click **Change Password** in the button bar. Your password is changed.

12.9.7. Reset Your Password

You can only reset your password if you have already provided answers to the security questions created by your administrator. See “Configure Your Password Reset Questions” if required.

If you forget your password while attempting to log in to VOSS-4-UC:

1. Enter your username in the **Username** field on the Log in screen.
2. Click the **Forgot Password?** hyperlink located below the **Log in** button.
3. Enter your username again.
4. Click **Reset my password**.
5. Click in each security question field and type the correct answer.
6. Click in the **New password** field and type your new password. Refer to **Minimum Password Length** and **Enable Password Complexity Validation** fields under *Customized Credential Policy* if required.
7. Click in the **Repeat password** field and re-type your new password.

8. Click **Reset my password**. Your password is changed.
9. Click the **Login** hyperlink if you want to attempt to log in again.

12.9.8. Configure Your Own Password Reset Questions

This procedure configures your password reset questions.

Prerequisites:

- The credential policy applied to your user account must have **Number of Questions Asked During Password Reset** set to > 0 .

Perform these steps:

1. Log in to VOSS-4-UC.
2. Click the arrow next to the logged in user at the top right-hand side of the screen.
3. Choose the **Password Reset Questions** option from the drop-down menu. The **Password Reset Questions** screen is displayed.
4. Type your password in the **Current Password** field.
5. Choose the required security question from the **Question** drop-down list.
6. Enter your answer to the above question in the **Answer** field. All answers should differ from each other.
7. Repeat steps 5 and 6 until you have configured the required amount of security questions (as determined by your administrator).
8. When you're done, click **Update Security Questions**.
Your security questions and answers are updated.

12.9.9. Unlock a Locked Out User

This procedure unlocks a user's account, where the user is locked out on account of a credential policy violation.

Perform these steps:

1. Log in as provider, reseller, or customer admin.
2. Choose **User Management > Users**.
3. Click the user whose account you want to unlock.
4. On the **Account Information** tab, clear the **Locked** checkbox.
5. Click **Save**.

12.9.10. Unlock a Locked Out Administrator

This procedure unlocks an administrator's account, where the administrator is locked out on account of a credential policy violation

Prerequisites:

- You must be an administrator user at a hierarchy node above the hierarchy node of the locked out admin user.

Perform these steps:

1. Log in as provider, reseller, or customer admin, depending on the location of the locked out administrator.
2. Go to **User Management > Admins**.
3. Click the administrator whose account you want to unlock.
4. On the **Account Information** tab, clear the **Locked** checkbox.
5. Click **Save**.

12.9.11. Manually Disable a User Account

This procedure manually disables a user account. Usually, a user account is disabled when the password has expired. However, an administrator can manually disable a user account at any time.

Note: A user account is typically disabled when the password expires. However, an administrator can disable a user account at any time. Manually disabling a user is preferred to manually locking out a user as you can provide the reason for disabling.

Prerequisites:

- You must be an administrator to manually disable a user account.

Perform these steps:

1. Log in as provider, reseller, or customer admin.
2. Go to **User Management > Users**.
3. Click the user whose account you want to disable.
4. On the **Account Information** tab, select the **Disabled** checkbox.
6. In the **Reason for Disabled** field, enter the reason the account is disabled. The reason is displayed to the user when their next login attempt fails.
7. Click **Save**.

12.9.12. Manually Disable Administrator Account

Usually, an administrator account is disabled when the password has expired. However, an administrator at a higher hierarchy level can manually disable an administrator account at any time.

Note: Manually disabling an administrator is preferred to manually locking out an administrator as you can provide the reason for disabling.

1. Log in as provider, reseller, or customer admin.
2. Choose **User Management > Admins**.
3. Click the administrator whose account you want to disable.
4. Click the **Account Information** tab.
5. Select the **Disabled** check box.
6. Enter the reason the account is disabled in the **Reason for Disabled** field. This reason will be displayed to the administrator when the next login attempt fails.
7. Click **Save**.

12.10. Cisco Unity Connection (CUC) Passwords

12.10.1. Reset UC Passwords Overview

VOSS-4-UC maintains details of user credentials. A VOSS-4-UC user can also be a corresponding user on a number of devices. In particular, users can have password (and PIN) credentials for:

- VOSS-4-UC user
- Unified CM (also PIN)
- Cisco Unity Connection (also PIN)
- LDAP user on Unified CM
- LDAP user on Cisco Unity Connection
- Conferencing user - WebEx, Zoom or PexIP (also PIN)

The Reset UC Passwords feature allows you to select a username for a user on Unified CM at a selected hierarchy and then, given the configured services for the user, you can select a check box to reset the user's password and/or PIN for the services.

The feature can be used by an administrator at the provider, customer and site hierarchy. It will, given a selected username, also enable options to select other devices for password modification and also displays notices or warning messages to indicate available devices and exclusions.

For example, the password of a Unified CM user that is also an LDAP user, cannot be modified. Such a user is also not a VOSS-4-UC user. In other instances, the VOSS-4-UC password is also reset when a user's device password is reset.

If a user is an LDAP user on either Unified CM or Cisco Unity Connection and they are selected, then only the PIN for the device will be reset.

Note: When bulk loading updates to passwords, the bulk load sheet only needs to specify values for the user and updated passwords - other fields can be left blank. See: [Bulk Loading a File](#).

12.10.2. Resetting UC Passwords

1. Log in as the provider, customer or site administrator and navigate to the hierarchy at which the Unified CM is available.
2. Choose **Subscriber Management > Reset UC Passwords**.
3. Choose the username on Unified CM from the User drop-down list.
4. Check boxes will show for the selected user according to the associated devices. The devices can be:
 - Reset CUC
 - Reset WebEx
 - Reset CUCM
 - Reset Pexip

5. Select the check boxes for the devices on which the user's password or PIN needs to be changed. Note that a PIN can only be reset for CUCM, CUC or Pexip, not for WebEx or VOSS-4-UC, because these have no PIN functionality.

Read the displayed Password or Pin notices and warnings. The messages show the conditions as to when passwords and PINs will be reset.

Note that the content of these messages must be inspected as the check boxes are selected or cleared, because the conditions change according to the status of the check boxes.

If no check boxes are selected, then only the VOSS-4-UC password can be changed. If the user is an LDAP user on either Unified CM or Cisco Unity Connection, then only the PIN for the device can be changed.

6. Click **Save**.

12.11. Access Profiles

12.11.1. Access Profiles: Overview

Access profiles define model types that a user is permitted to access. Access profiles are assigned to users via Roles.

Note: Access Profiles (APs) are subject to the following requirements:

- Default APs: adhere to the following hierarchy of permissions: **Provider > Reseller > Customer > Site**. For instance, default Customer APs have less permissions than Provider APs.
- Cloned APs: the cloned AP has equal or less permissions than the AP of the admin user who creates the clone.

When a System Upgrade is performed, the default access profiles are updated in accordance with the above.

Note: Existing cloned APs are **not** upgraded. You have to manually update them, or re-clone and modify them from the upgraded, default versions as needed.

See Also:

- Access Profile Permissions and Operations in the Core Feature Guide
- Access Profile Field Reference in the Core Feature Guide

12.11.2. Access Profile Permissions and Operations

Administrators *above* Provider level can maintain access profiles as a part of role management.

An access profile assigned to a role provides a general set of permissions and type-specific operations which are associated with specific models.

For type-specific operations, wild cards may be used in model references, for example `data/*`.

Note:

- Type-specific permissions that are also configured as general permitted operations will override the general permissions.
-

The default access profiles show typical configurations, for example an Operator-type profile at a hierarchy would *only* require **Read** type-specific permissions, while the administrator profile at the same hierarchy would have **Create**, **Update** and **Delete** permissions for the same type.

The default access profiles of the following administrators above Provider level have full general and type-specific permissions to all models:

- `hcsadmin` (Provider product deployment)
- `entadmin` (Enterprise product deployment)

The lists below provide details on the types of settings.

- **Miscellaneous Permissions**

Many of these are general permissions that can be overridden per model as **Type Specific Permissions**.

The explanations below show the affect of enabling the permission.

- **Api Root:** Access to API root endpoint is permitted.
- **Device Type Root:** Access to API `device` type model root endpoint is permitted.
- **Export Data:** General permission to export data.
- **Help:** On-line help button is shown.
- **Help Export:** Help data can be exported.
- **Json Editor:** Access to JSON Editor for the editing of model instances. A **JSON Edit** button is available on the GUI form.

- **Login:** Login is allowed.
- **Meta Schema:** Meta schema is accessible.
- **Model Type Choices:** Access to API choices endpoint of model types is permitted.
- **Model Type Root:** Access to API model root endpoint is permitted.
- **Operations:** Operations on models are permitted.
- **Tag:** Models can be tagged.
- **Tool Root:** Access to API tool root endpoint is permitted.
- **Upload:** Uploads are allowed.

- **Type Specific Permissions**

These are typically available on the GUI when listing or showing the type.

Note:

- The available permissions can vary according to the selected type.
- If the **Create** type specific permission is enabled for a model type, this also enables **Clone** of a model instance.

Typical operations are listed below:

- **Create, Delete, Read, Update:** management operations on models.
- **Configuration Template, Field Display Policy:** create these for the model.
- **Export, Export Bulkload Template :** allow export formats of the model.
- **Bulk Update:** from a GUI list view, more than one item can be selected and updated.
- For system level administrators above provider level: **Purge** for device models. From a list or instance view, remove the local database instance but retain it on the device.

Note: This operation is only applicable in cases where the UC server is still online and available in the VOSS-4-UC system.

- For designers: **Migration:** a migration template can be obtained.
- For designers: **Tag** and **Tag Version:** a model instance can be tagged and a version provided.

See Also:

- Access Profile Overview in the Core Feature Guide

12.11.3. Access Profile Field Reference

Title	Field Name	Description
Name *	name	The name that is given to the Access Profile.
Description	description	A description for the Access Profile.
Full Access	full_access	Enabling this flag, grants the user full system access.
Miscellaneous Permissions	miscellaneous_permissions	The list of miscellaneous operations permitted by this Access Profile.
Type Specific Permissions	type_specific_permissions	The list of types that are permitted by this Access Profile.

Type Specific Permissions

Title	Field Name	Description
Permitted Type *	type	The type that is permitted by this Access Profile. This field supports the use of the * wildcard.
Permitted Operations	operations	The operations that are permitted by this Access Profile for the given type.

See Also:

- Access Profile Overview in the Core Feature Guide

12.12. Self Service

12.12.1. Self Service: Overview

Using the VOSS-4-UC Self Service interface, users can configure their own phone settings, including voicemail, call forwarding, availability, and speed dials.

To access the Self Service interface, a user must be assigned a SelfService role in VOSS-4-UC. A user may get a SelfService role in one of the following ways:

- Automatically when synced from LDAP, if the LDAP Sync has the User Role configured to a SelfService role.
- By default when synced from Cisco Unified Communications Manager.
- Manually assigned by an administrator using **User Management > Users**.

To access the Self Service interface, the user enters

```
https://<Hostname>/selfservice/#/login?theme=[your_theme]
```

in the browser URL field.

Note: Access to the Self Service interface and the VOSS-4-UC Admin Portal are mutually exclusive. Therefore, if an administrator needs access to the Self Service interface, the administrator needs a second user configured in VOSS-4-UC with a SelfService role assigned to it.

If the theme value is set as `login?theme=cisco_selfservice` then the theme will revert to the Self-service theme that has been set as the default.

12.12.2. Self-Service and User Configuration

As an Administrator, you can:

- Configure various aspects of the Self-Service interface
- Provide user access to Self-Service
- Configure services for the users as required

This table provides a summary of the configurable items for the Self-Service interface.

Configurable Items in Self-Service Interface

Task or Item	Description
User access	A user can log in to the Self-Service GUI if a 'System User' entry exists for the user. A 'System User' entry is created automatically when a user is added as a subscriber. You can grant a user access to Self-Service by creating a user with a Self-Service role directly in the System user interface. A user with this role is not able to view devices or any services associated with the devices. Manually added users also cannot view personal information such as first name, last name, address, department, etc.
User Authentication	Self-Service authentication is controlled by the administration interface using the same three authentication methods: Standard , LDAP , and SSO .
GUI Themes and Branding	The Self-Service GUI interface can be branded by configuring Cascading Style Sheets and images and logos. It uses the same theme upload and download interface used for the administrator GUI. The theme itself however, is different between the administrator and Self-Service interface (based on the user role). The log in page theme is also loaded from the URL: <a href="https://<host>/selfservice/#/login?theme=mytheme">https://<host>/selfservice/#/login?theme=mytheme
Personal Phones (Remote Destinations)	You can automatically assign a remote destination profile (RDP) to a user so that they can manage their own personal phones and simultaneous ring settings. Select the User can enable Personal Phone Management (add Remote Destination Profile) check box on the Personal Phones tab under Customizations > Self Service Feature Display Policy . If no RDP is associated to the user, the Personal Phones management interface in self-service is hidden. Multiple RDPs for each user are not supported. The Personal Phones management interface in Self-Service is also hidden if a user has more than one RDP associated.

For more information, see:

- [Add Subscribers](#)
- [Add an Admin User](#)
- [User Authentication](#)
- [Download and Update a Theme on the Legacy Admin Portal](#)
- [Create a Custom Self-Service Role](#)

Task or Item	Description
Dual-Mode Phones - Mobile ID	If a user has a dual-mode device associated, they can manage the phone number and simultaneous ring settings for the device. If no dual-mode device is associated, the relevant settings are hidden in the Self-Service interface.
Voicemail	Voicemail settings are only visible in the Self-Service interface if the user has a voice mailbox. Click the Voicemail tab of Customizations > Self Service Feature Display Policy to set voicemail settings, notification devices, and SMS Interfaces.
Passwords and PINS	Users can modify their own Passwords and PINs if the Self-Service Feature Display Policy is set to 'Show' these items. Click the My Information tab of Customizations > Self Service Feature Display Policy to change this setting.
Link to a WebEx server	Users have a link to their WebEx server from the Self-Service interface if this item is set to 'Show'. Click the My Information tab of Customizations > Self Service Feature Display Policy to change this setting.
Hyperlinks to predetermined objects or items such as a support site or downloadable User Guide	As the administrator, you specify the hyperlinks that appear in the Self-Service interface. Refer to the VOSS-4-UC "Self-Service Guide".
Call Forwarding	Displays the call forwarding status of a user's phone lines. You can specify whether Basic or Advanced call forwarding is set to 'Show' in the Self-Service interface. Click the Call Forward tab of Customizations > Self Service Feature Display Policy to change this setting.

For more information, see:

- [Configure Phones](#)
- [Voicemail: Overview](#)
- [Create a Custom Self-Service Role](#)

12.12.3. Create a Self-Service Link

1. Navigate to the required hierarchy.
2. Click **Add** and enter a Name for the set of links.
3. Enter one or more Description and Link. The Description will display on the Self-Service GUI. The Link is in the format of a URL, for example: `http://...`

13. Role Management

13.1. Roles

13.1.1. Role-based Access

The system implements role-based access control through:

- Hierarchies
- User Roles

All users are added to the system at a specific hierarchy level. A user added at a specific hierarchy can only view system resources available to users at that hierarchy.

On the interface, this means that the user has no visibility of nodes outside of the sub-tree starting at the parent hierarchy. The user may change to a level of the hierarchy below the parent hierarchy.

The diagram shows that a user at VS-Corp has no visibility of GenCorp and InGen.

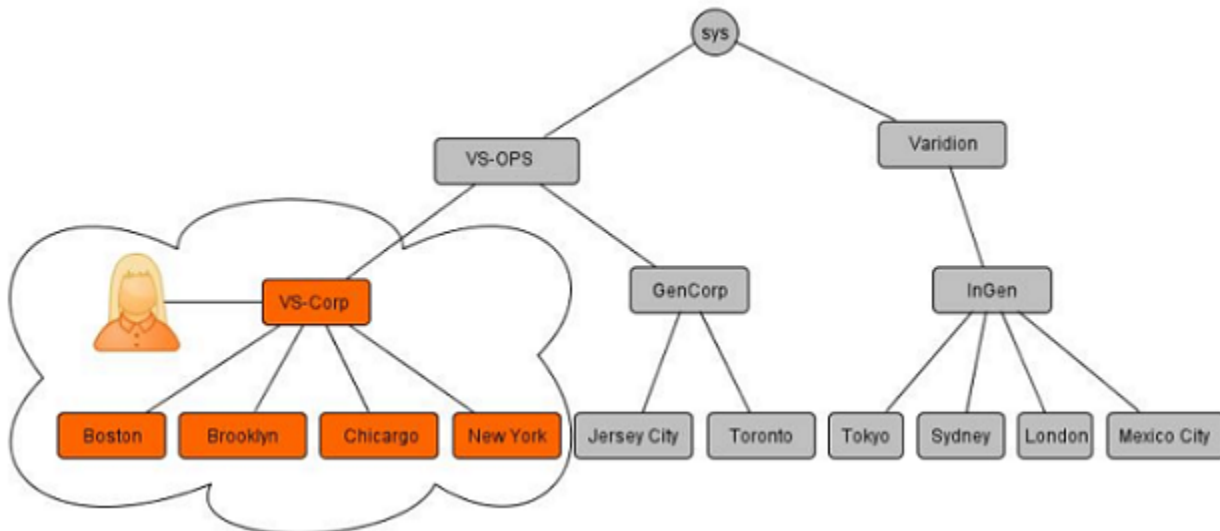

From the context of the hierarchy level that a user was created at, role-based access is implemented. When users are added to the system at a hierarchy level, a User Role can be assigned to them.

A user role is a combination of:

- Rules applying to the role, specifically, the hierarchy types applying to the role. A role is only available to a user at a hierarchy level that belongs to a hierarchy type associated with the role. For example, a

Site Administrator role may have a rule that associates it with Site and Building hierarchy types, but not Customer hierarchy types. In this way a Site Administrator role cannot be associated with a user created at a Customer hierarchy level. A hierarchy rule is therefore enforced by the role.

- System permissions to resources from that hierarchy.
- Access Profiles associated with a User Role that determine access specific operations supported by different models and/or on miscellaneous permissions.
- The visibility of resource attributes.
- The look and feel of the interface.
- Default values of resource attributes.

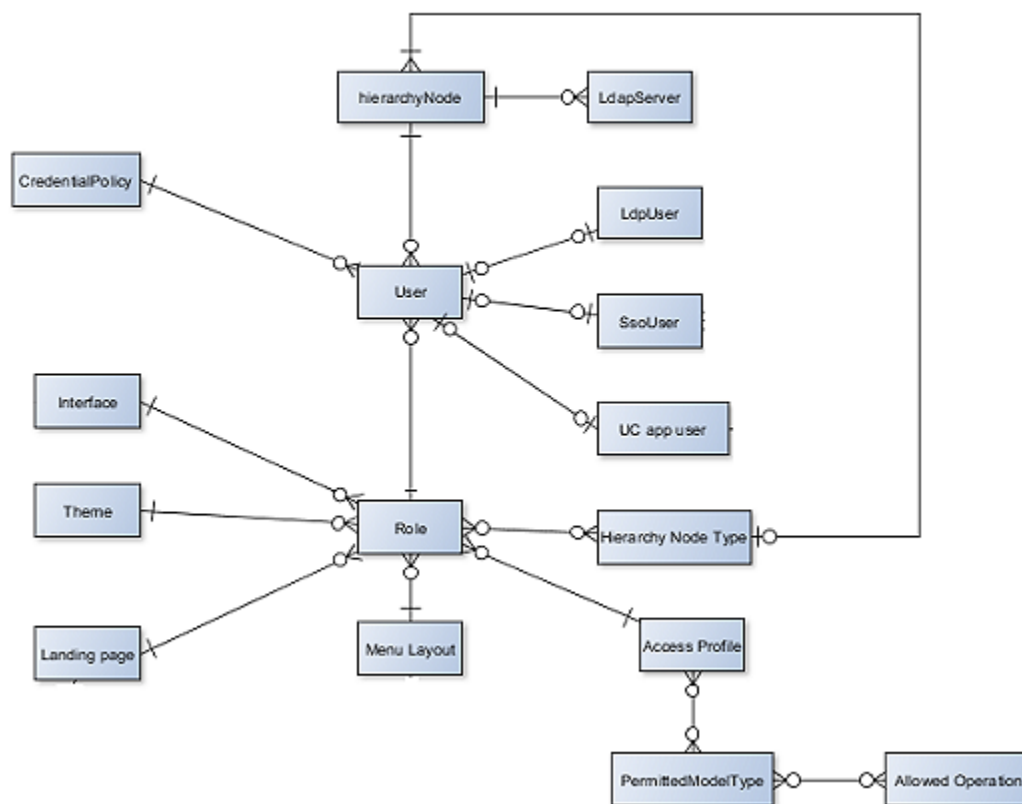

Related Topics

- Role-based Access for Multi-vendor Subscriber in the Core Feature Guide
- User Roles in the Core Feature Guide

13.1.2. User Roles

VOSS-4-UC ships with a powerful role-based access framework that ties a user role to menu layouts, access profiles, landing pages, and themes.

Note: The system comes with a default set of roles, menu layouts, access profiles, landing pages, and themes.

Default roles:

- HCS Admin
- Provider
- Reseller
- Customer
- Site
- User

A user role in the system combines the look and feel of the system interface with a number of default permissions and values.

Each user role is a combination of:

Landing page	The content of the first page you see when logging in, including links on the page.
Menu layout	The menu layout associated with a user role defines the available menu, and where relevant, may also include the configuration templates and the field display policies (FDP) that apply to the resources that the menu links to.
Theme	The appearance of the user interface can be associated with a role.
Access profile	Permissions for resources are defined in Access Profiles. An Access Profile can be associated with a user role.
Interface	Defines the application interface the role definition applies to. Roles support the Administration interface and the Self Service interface.

When creating or updating a user, you can select their role. The user will then have a landing page, menu, theme, and interface defined for their user role. For example, the Configuration Template defaults and settings as well as Field Display Policy views of the menu associated with the role apply.

A user role may be assigned to more than one users. The user hierarchy and role serve as components of role-based access control in the system.

A number of default user roles are provided. Each user role has a predefined landing page, menu layout and access profile. Each of these elements, including theme, can be customized.

Note: Users cannot modify their own user role or the associated Access Profile, Menu Layout, Landing Page or any of the Configuration Templates or Field Display Policies associated with the role.

A role may be associated with a specific hierarchy. For example, the Site Admin role can only be assigned to a user at the Site hierarchy level.

Related Topics

- Add and Edit Roles in the Core Feature Guide
- Role-based Access in the Core Feature Guide

13.1.3. Add and Edit Roles

Provider administrators can manage the roles that are available for administrators, operators, and users at lower levels in the hierarchy.

Note: References to HCM-F and Shared Data Repository (SDR) are only relevant if installed.

Edit an Existing Role

To edit an existing role:

1. Log in as provider administrator.
2. Go to **Role Management > Roles**.
3. Locate the role you want to change; then, click on the role to open it.
4. Update the role settings, as required.
5. Save your changes.

Add a New Role

To add a new role:

1. Log in as provider administrator.
2. Choose **Role Management > Roles**.
3. Click **Add**.
4. Define role settings:

Setting	Description
Name*	Name of the role. This field is mandatory.
Hcs Component Access*	Controls which HCM-F components (FF or SA) that users with this role have access to. Used with Hierarchy Type and Service Assurance Role Type when mapping roles to HCM-F. This field is mandatory.
Service Assurance Role Type*	Controls read/write access to HCM-F components. Used with Hierarchy Type and Hcs Component Access when mapping roles to HCM-F. This field is mandatory.
Hierarchy Type*	The type of hierarchy nodes applicable at the selected hierarchy level. For example, at Provider level, the following values are allowed: Provider, Reseller, Customer, and Site. While at the Reseller level, the following values are allowed: Reseller, Customer, Site. Controls which roles are available at which levels in the hierarchy. Also used with Hcs Component Access and Service Assurance Role Type when mapping roles to HCM-F. This field is mandatory.
Description	Description of the role.
Access Profile*	Permissions for resources are defined in Access Profiles. This field is mandatory.
Menu Layout	The menu layout assigned to the role. Controls the menu options available to users assigned to the role.
Landing Page	The home page assigned with the role. Controls what the home page looks like for users assigned to the role.
Theme*	The name of the theme assigned to the role. The theme controls the overall look and feel of the Admin Portal. This field is mandatory.
Self Service Feature Display Policy	The selected Self Service Feature Display Policy that is associated to the role.
Self Service Links	Provide useful links to Self Service end users.
Custom Interfaces	Add Interface Types and Names for the role. The available custom Interface Type is InterfaceBusinessAdminPortal, which provides access to the Business Portal Admin Portal. Choose profile MS Only for admins to manage Microsoft subscribers in the Business Admin Portal.

5. Click **Save** to save the role.

13.1.4. Clone a Role

Use this procedure to clone an existing role for a specific hierarchy node (provider, reseller, customer, or site).

Procedure

1. Log in as entadmin or provider administrator.

Note:

Administrators can clone roles associated with, or below, their level in the navigation hierarchy.

2. Choose **Role Management > Roles**.
3. Click the role that you want to clone.
4. Choose **Action > Clone**.
5. Enter a unique name for the role in the **Role** field. Make the name as descriptive as possible using up to 50 alphanumeric characters, including spaces, period(s), hyphens (-), and underscore characters (_).
6. (Optional) Add a description for the role in the **Description** field.
7. Click **Save** to save the role to the hierarchy that appears in the breadcrumb.

13.1.5. Create a Service Assurance Only Role

To restrict an administrator to performing only service assurance tasks, you need to create the appropriate service assurance only role.

Procedure

1. Log in as entadmin or provider administrator.
2. Choose **Role Management > Roles**.
3. Click **Add**.
4. Enter a name, and optionally a description, for the role.
5. Select the hierarchy type for the role.
Controls the hierarchy level that the role is available at.
6. From the **Hcs Component Access** drop-down, choose **Service Assurance Only**. The privileges, menu layout, and landing page values are automatically set to the appropriate values for a service assurance only role and cannot be overridden.
7. Optionally, select a theme for the role.
8. Click **Save**.

13.1.6. Create a Fulfillment Only Role

To restrict an administrator to performing only fulfillment tasks, you need to create the appropriate fulfillment only role.

Procedure

1. Log in as entadmin or provider administrator.
2. Choose **Role Management > Roles**.
3. Click **Add**.
4. Enter a name, and optionally a description, for the role.
5. Choose the hierarchy type for the role.
Controls the hierarchy level that the role is available at.
6. From the **Hcs Component Access** drop-down, choose **Fulfillment Only**.
7. Choose the privileges for the role.
8. Optionally, select a menu layout, landing page, and theme for the role.
9. Click **Save**.

13.1.7. Create a Custom Self-Service Role

A default Self-Service feature display policy is available in VOSS-4-UC. When providers, resellers, customers, and sites are added in VOSS-4-UC, the default Self-Service feature display policy is assigned automatically to the Self-Service role at each level of the hierarchy. The default Self-Service feature display policy allows you to perform the following tasks in the Self-Service interface:

- Add Voicemail
- Enable Remote Destination Profile (RDP)
- Manage phones and phone lines (but adding smart devices is not allowed)
- Assign configuration templates for phones, RDP, and voicemail
- Link to Launch Webex from Self-Service interface

Most options are set to **Show**, rather than **Hide** to indicate that the Self-Service user can view and edit the item in the Self-Service interface. For example, My Availability, Speed Dials, Call Forward Basic, Advanced Call Forwarding, Ring Schedules, Advanced Timer options, Password, and PIN are all set to **Show**.

Perform this procedure to modify the default Self-Service feature display policy, create a custom Self-Service role, and assign the custom Self-Service role to users.

Procedure

1. Log in as entadmin or provider administrator.
2. Clone the default feature display policy:
 - a. Choose **Role Management > Self Service Feature Display Policy**.
 - b. Choose the Default Self-Service feature display policy. The Self Service Feature Display Policy (Default) screen opens.
 - c. Click **Action > Clone**.
 - d. On the **Base** tab, type a new name for the Self-Service feature display policy in the **Name** field.

- e. Change options on the **Base, Phones, Personal Phones, My Information, Voicemail, or Call Forward** tabs as required:

On the **Phones, Personal Phones** and **Voicemail** tabs, there are two similar check boxes (one associated with entitlement, the other not). For example, on the **Voicemail** tab, the first check box is labeled **User can enable Voicemail (Add a Voicemail Account)** and the second check box is labeled **User can enable Voicemail only if the user is entitled to Voicemail**.

If the Entitlement Feature is used, that is an Entitlement Profile is associated to the subscriber on the **Entitlement Profile** drop-down on the **Subscriber Management > Subscribers** page, then select the second check box. If an Entitlement Profile is not associated to the subscriber, then select the first check box, as the second check box is no longer applicable.

Similarly, select the appropriate check boxes on the **Phones** and **Personal Phones** tabs.

To	Do
Allow users to add their own smart devices	On the Phones tab, click User can add own smart devices .
Add more phones or devices from Cisco Unified Communications Manager	On the Phones tab, complete information to add the phones or devices to the Device Configuration Templates for User area of the screen.
Change the Default RDP configuration template	On the Personal Phones tab, choose a different template from the Device Configuration Template for End-User Remote Destination Profile Add drop-down menu.
Change the Default Voicemail configuration templates	On the Voicemail tab, choose different templates from the drop-down menus.
Show/hide individual Voicemail options such as Voicemail Basic, Voicemail Devices, Phone Notification Device, Voicemail Alternative Extensions	On the Voicemail tab, choose Show from the specific drop-down menus.
Show WebEx link in the Self-Service interface	On the My Information tab, select Show from the Link to Webex self service portal drop-down menu. Note: The WebEx link (Protocol, Address, Port, and Site Name) must be defined in Device Management > WebEx > Servers and the subscriber must have access to WebEx on the WebEx tab (Subscriber Management > Subscribers). Ensure that when you expand the WebEx user form, the Enable CET and Enable PMR check boxes under Privilege are selected.
Hide Self-Service options from users	Choose Hide from the appropriate drop-down menus.

- f. Click **Save**. The custom Self-Service feature display policy appears in the list and can be assigned to Self-Service roles.

3. Assign the custom Self-Service feature display policy to one or more Self-Service roles.

- a. Choose **Role Management > Roles**.
 - b. Choose a provider, reseller, customer, or site level Self-Service role.
 - c. From the **Self Service Feature Display Policy** drop-down menu, choose the custom Self-Service feature display policy you created in step 2.
 - d. Click **Save**.
 - e. If desired, repeat substeps b to d for other Self-Service roles.
4. If a Cisco Unified Communications Manager sync or LDAP sync is not performed, manually assign the custom Self-Service role to one or more existing users.

Note:

You do not need to perform this step for new users who are added to the system in the future. New users are automatically assigned the Self-Service role that you specify for the reseller, customer, or site when it is added to the network.

- a. Log in as provider, reseller, or customer administrator.
- b. Choose **User Management > Users**.
- c. Choose the user for whom you want to assign the custom Self-Service role.
- d. From the **Base** tab, choose custom Self-Service role from the **Role** drop-down menu.
- e. Click **Save**.

13.1.8. Business Admin Portal Custom Interface

A role custom interface is available to assign to an administrator user so that the administrator can access the Business Admin Portal. Refer to the “Business Admin Portal” online help or documentation for details on this interface.

1. Log in as a provider administrator.
2. Choose **Role Management > Roles** and either choose an existing role to modify or create a new role (refer to “Clone a Role”).
3. Click + next to **Custom Interfaces**, and add an entry to the Custom Interfaces group:
 - a. From the **Interface Type** drop-down, choose **InterfaceBusinessAdminPortal**.
 - b. From the **Name** drop-down, choose the required interface name.
4. Click **Save**.

An administrator with this user role will be able to log in on the Business Admin Portal when appending the following endpoint to the login URL:

`https://<VOSS-4-UC IP>/business-admin/`

13.2. Themes and Layouts

13.2.1. Themes

Themes control the look and feel of the entire user interface. This contains all aspects of the presentation including the images, logos, colors, fonts, sizing and positioning. Login and interface header text can also be managed by the VOSS-4-UC theme feature. The chosen look and feel can also be applied to the Login page.

Themes can be managed:

- In the Admin Portal (including legacy): using the **Themes** menu (default path: **Role Management > Themes**).
- In the Business Admin Portal: using the **Themes** menu (default path: **Tools > Themes**). Themes managed here follow the same method as on the Admin Portal and is not file-based.

Important: Theme management from the Legacy Admin Portal differs from the Admin Portal. Refer to the topics on file-based themes for details on Legacy Admin Portal theme management.

- There are two ways to set up a theme in the system:
 - File based - only applicable for the Legacy Admin Portal and takes precedence if it exists.
 - Branding, in other words the customisation theme colour choice options - applicable to the Admin Portal, Business Admin Portal. If no file-based theme is a part of the theme, then this applies to all interfaces: Legacy Admin Portal, Admin Portal, Business Admin Portal.

New themes can be added and existing themes can be edited. These are associated with a user's role. There is no limit to the number of themes that can be added and applied. It is a common practice to have a theme associated with a specific customer (company).

The default theme that applies to the Admin Portal when the system is initially built, is available on the VOSS-4-UC system and can be used as the baseline template.

13.2.2. File Based Themes

The file-based theme is in the form of a Cascading Style Sheet (CSS) to be exported, edited and re-imported as required.

While all aspects of the exported CSS can be modified, we recommend that the default theme is used as a template in terms of basic design in order to prevent usability or functional issues.

The CSS file itself is simple to export and edit. Clear headers in the CSS file indicate which area of the Admin Portal the design applies to. The headers include the following components:

- Navbar
- Shortcut menu
- Hierarchy breadcrumbs
- Quick search
- Tree menu
- Toolbar

- List
- Form

Images can be stored with the theme or referenced with the use of relative path names.

The ability to view themes created at a given hierarchy level can be restricted from users at a lower hierarchy level by use of the **Hide from Lower Hierarchies** check box. If this check box is checked for a particular theme, that theme will no longer be visible on the Themes list view screen at the lower level hierarchy.

The theme feature is applied to either the Administration or Self-Service interface. If no Interface is specified, the new login theme will also have its interface set to Administration.

It also includes a **Use this Theme to style Login page** check box, which when selected, applies the chosen look and feel to the Login page across the system. Currently, the system allows only a single theme to be applied to the Login page per Interface. This means that a new or updated theme with Interface and Login page setting that corresponds to an existing theme, will result in the disabling of the Login page style on an existing theme with the same Interface setting.

The Login page theme can also be applied to the Login page during the log in process by adding a suffix to the login request URL. See [Set the Login Page Theme and Text on the Legacy Admin Portal](#).

13.2.3. Theme Field Reference

Base

Title	field name	Description
Theme Name *	name	The name that is given to the Theme.
Navbar Text	banner_title	Text to display on the top navigation bar of the Admin Portal.
Use this Theme to style Login page	is_login_theme	Should Login page use this theme? Applies to the relevant theme's login page: either the Self-service or Admin Portal.
Site Title	title	The title for the site
Import File *	import_file	
Backup Enabled	backup	Create backup if existing theme exists

Login Page Details

Title	title	Title displayed at top of login page.
Banner text	banner	Banner text displayed at bottom of login page.

13.2.4. Add a Theme on the Legacy Admin Portal

1. Prepare the theme file:

- a. The recommended procedure is to use an export of an existing theme as a baseline and update it with a new name, images and colours as required. Refer to [Download and Update a Theme on the Legacy Admin Portal](#) for details.
- b. Create a folder with the required name of the theme and un-zip the exported theme in it, maintaining directory structure.

The name of the folder must be the same as the intended theme name (only alphanumeric characters or underscore can be used, with no spaces or special characters).

- c. Add any CSS overrides to the file. Note that only the definitions as shown in the export of a provided CSS file `skin.css` can be modified.
- d. Add required image files in this folder (if any).

Important: If customization is done on MS Windows, check that no `desktop.ini` files reside in the directory tree of the theme before compressing it.

- e. Create a .zip archive file with the same filename as the folder.

2. Add the theme to the system:

- a. Choose the hierarchy level at which the theme will be created.
- b. Choose **Role Management > Themes** to open the **Themes** list view.
- c. Click **Add** on the button bar to open the **Themes** input form. Note that themes can only be customized by a Provider Administrator (or higher).
- d. Enter the **Theme Name** (same as the file name created above).
- e. Enter **Navbar Text** if needed. This will show on the navigation bar next to the logo.
- f. Enter an appropriate **Site Title** if required. The site title entered here is the text displayed in the browser tab.
- g. Click the **Browse** button to import the created theme zip file. Wait until the system displays the file chosen in the **Import File** field.
- h. If the theme must also apply to the login page, select the **Use this Theme to style Login page** check box.
- i. To set login banner text and notices on the login page, refer to [Set the Login Page Theme and Text on the Legacy Admin Portal](#). The **Use this Theme to style Login page** check box does not have to be selected for banner text to show.
- j. If you want to hide the theme from lower level hierarchies, select the **Hide from Lower Hierarchies** check box. Users logged in at lower level hierarchies will not be able to see that particular theme on the **Themes** list view screen.
- k. For details on the **Theme Customization** tab controls, refer to [Create a Theme in the Admin and Business Admin Portal](#).

Note: If any details are added on this tab, *all* fields should be provided with input.

- l. Choose **Interface** to which the theme applies from the drop down. By default the theme applies to the Administration interface.
- m. Click **Save** on the button bar when complete.

Note: Do not leave the screen until the processing of the theme completes and theme list is refreshed. This can take a few minutes depending on details and complexity of theme uploaded.

13.2.5. Download and Update a Theme on the Legacy Admin Portal

1. Choose the hierarchy level at which the theme will be applied. Note that themes can only be customized by a Provider Administrator (or higher).
2. Choose **Role Management > Themes** to open the **Themes** list view.
3. Click the theme that you want to download.
4. Click **Action > Download** on the button bar to download the theme. The exported file is a .zip archive with the name of the theme. The archive contains a folder with the theme name and files called skin.css and skin.less in it.
5. Refer to the recommended practice to edit the Less file at the end of this topic, otherwise save the file and open the CSS file in a text editor.
 - Headers are clearly marked and apply to design areas within the Admin Portal.
 - Colors, sizes, fonts, images, and so on, can all be overwritten with the required formats.
 - Images must be identified with the correct file path name. Preferably, do not use '/' preceding the path name; rather use relative paths, in other words a path relative to the CSS file location. For example, if your created an image sub-folder called 'img', use 'img/myimage.png'. After upload, the image should be viewable when opening the URL: *http://<hostname>/www/themes/mytheme/img/myimage.png*
6. When editing is complete, make sure the directory folder name is the same as your theme name. Compress the folder and save the file with the theme name and a .zip file extension.

An error message will display on the user interface if the file does not have a valid file extension.

Note that any files or folders inside the zip file archive that start with a '.' character will be silently discarded when unzipping the theme. For example, if the zip archive contains any files named `._.DS_Store` or `.directory`, they will be ignored.

Important: If customization is done on MS Windows, check that no `desktop.ini` files reside in the directory tree of the theme before compressing it.

7. Choose **Themes**:
 - a. For an update, choose the theme name and click **Browse** adjacent to **Import File** and then open the same theme name. Optionally select the **Backup Enabled** check box to create a backup of the current theme on the server. Click **Save** to complete the import process.

If a theme update does not require an updated CSS in a zip file but only updates the text of the theme, then no file upload is required. For information about the other fields on this form, refer to the topic on adding a theme.

- b. To delete a theme, choose it from the list and click **Action > Delete**.

The preferred way to edit a theme is to edit and compile the Less files. Refer to the “Less files and Theme Customization” topic in the “Advanced Configuration Guide”.

- All changes that are made directly in the CSS files will have to be manually carried over after each changes in the Less files.
- Edit the Less files and compile them to get the new CSS files.
- The aim with Less is that a theme can be customized with the minimum of technical knowledge (as with for example Twitter Bootstrap [<http://getbootstrap.com/customize/>]).

For an introduction to Less, visit the official website [<http://lesscss.org/>]. To compile the Less theme, a Less compiler is required. The following list shows examples:

- Online [<http://lesscss.org/usage/index.html#online-less-compilers>]
- on your desktop [<http://lesscss.org/usage/index.html#guis-for-less>]
- IDE [<http://lesscss.org/usage/index.html#editors-and-plugins>]

13.2.6. Set the Login Page Theme and Text on the Legacy Admin Portal

1. Choose the hierarchy level in which the theme was created or to which the theme belongs.
2. Choose **Role Management > Themes** to open the Themes list view.
3. Click the required **Theme Name** that you want to use for the Login page.
4. On the **Base** tab, select the **Use this Theme to style Login page** check box.

If the check box is selected, and a theme with the same Interface already has the Login page check box selected, this will result in the disabling of the check box on the existing theme. There can only be one Interface-Login page combination on the system, so that any new themes or updates to existing themes may modify other themes on the system with the same Interface by disabling their Login page attributes. If no Interface is specified, the new login theme will also have its interface set to Administration.

5. On the **Login Page Details** tab, enter the required text in the **Title** field and **Banner Text** field. The text entered in the **Title** field will be displayed at the top of the Login page, above the logo. The text entered in the **Banner Text** field will be displayed at the bottom of the Login page, below the **Log In** button.

The banner text input box allows for multi-line input so that paragraphs can be created.

The maximum character length of the banner text is 2048 characters.

Banner text is displayed in the format that it is entered into the input box upon configuration. If cookie and security policy references are added, these show as links that open in new browser tabs.

6. In the **Banner Text** field, references to the cookie policy and privacy policy are added to the text as placeholders:

- `{{cookie_policy}}`
- `{{privacy_policy}}`

Input boxes are available on the Banner input form to add a caption and URL for each.

Although the cookie and privacy policy references are both optional, both their caption and URL fields become mandatory if they are used. The placeholder reference is then also required in the banner input box.

For suggested input on the use of cookies by VOSS-4-UC in the cookie policy text, see [VOSS-4-UC Cookie Policy](#).

Note that if a browser has a blocker installed that prevents new tabs from opening, this will affect the functionality of the links in the login banner.

Privacy policy links can also be added to user menus. Refer to [Privacy Policy Menu Items](#) and [Manage Privacy Policy Menu Items](#).

To customize the banner text style, refer to the topic on “Theme Banner Customization” in the “Advanced Configuration Guide”.

7. Click **Save** on the button bar when complete to implement the selection.

The Login page theme can also be applied to the login page during the log in process. Do this by adding the URL parameter `theme=<theme-name>` to the login request URL. This usage in the URL will apply and override any theme that is set as the login theme.

Note: For Self-service, if the theme value is set as `login?theme=cisco_selfservice` then the theme will revert to the Self-service theme that has been set as the default.

For example, when 2 themes are available in the system, XYZ and ABC and XYZ login page is set to be the default:

- Legacy Admin GUI:

`https://instance/login/` - Login page will show use XYZ theme

`https://instance/login/?theme=ABC` - Login page will show use ABC theme

- New VOSS Admin Portal:

`https://instance/portal/#/admin` - Login page will show use XYZ theme

`https://instance/portal/#/login?targetAppMode=admin&theme=ABC` - Login page will show use ABC theme

- Business Admin Portal:

`https://instance/portal/#/business-admin` - Login page will show use XYZ theme

`https://instance/portal/#/login?targetAppMode=business-admin&theme=ABC` - Login page will show use ABC theme

13.2.7. Login Banner

A banner, typically a security notice or user agreement, can be configured at a hierarchy level to show on the Administrator and Self-Service login page before login.

High level administrators who have access to the `data/LoginBanner` model can configure the banner. A banner can be created so that:

- Only one instance is allowed per hierarchy

If an administrator or Self-Service user logs in and belongs to a hierarchy for which there is no defined login banner, the first banner higher up on the hierarchy is displayed. If no banners are configured, then the user logs in without a banner.

The banner text is displayed in the format that it is entered into the input box upon configuration.

When the banner is configured, users will see the banner displayed on the login page after they enter their credentials and when they click the **Login** button. An **Agree** and **Cancel** button is shown beneath the banner.

Users then need to click the **Agree** button to complete the login. If they click **Cancel**, they are returned to the login page.

Note: This banner is independent of the text on the login screen that may contain a privacy policy reference. The privacy policy text and reference on the login page is configured as a part of the Login Page Details when managing a theme - see [Set the Login Page Theme and Text on the Legacy Admin Portal](#).

13.2.8. Self-service Theme Customization on the Legacy Admin Portal

This section provides steps to customize and add a Self-Service theme.

To customize an existing Self-service theme:

1. Choose the hierarchy level at which the theme will be applied. Note that themes can only be customized by a Provider Administrator (or higher).
2. Choose **Role Management > Themes** to open the **Themes** list view.
3. Click the Self-service theme that you want to download.
4. Click **Action > Download** on the button bar to download the theme. The exported file is a .zip archive with the name of the theme. The archive contains a folder and a .css file with the theme name in it, for example `voss_selfservice.zip` contains `voss_selfservice/voss_selfservice.css`.
5. Modify the .css file, for example `voss_selfservice.css`. Use your browser to inspect the elements of the theme on the GUI that you wish to customize.
6. When editing is complete, make sure the directory folder name is the same as your theme name. Compress the folder and save the file with the theme name and a .zip file extension.

An error message will display on the user interface if the file does not have a valid file extension.

7. Return to **Role Management > Themes**:
 - a. For an update, select the theme name and click **Browse** next to **Import File**, and then open the same theme name. Optionally select the **Backup Enabled** check box to create a backup of the current theme on the server. Ensure the **Interface** is set to "Self Service". Click **Save** to complete the import process.

If a theme update does not require an updated CSS in a zip file but only updates the text of the theme, then no file upload is required. For information about the other fields on this form, refer to [Add a Theme on the Legacy Admin Portal](#).

The preferred method to add a new Self-service theme is to downloading an existing theme to maintain directory structure and file naming conventions.

To add a new Self-service theme to the system:

1. Choose the hierarchy level at which the theme will be created.
2. Choose **Role Management > Themes** to open the **Themes** list view.
3. Click **Add** on the button bar to open the **Themes** input form. Note that themes can only be customized by a Provider Administrator (or higher).
4. Enter the **Theme Name** (same as the file name created above).
5. Enter an appropriate **Site Title** if required. The site title entered here is the title displayed in the browser tab.

6. Click the **Browse** button to import the created theme zip file. Wait until the system displays the file chosen in the **Import File** field.
7. If the theme must also apply to the login page, select the **Use this Theme to style Login page** check box.
8. To set login banner text and notices on the login page, refer to [Set the Login Page Theme and Text on the Legacy Admin Portal](#). The **Use this Theme to style Login page** check box does not have to be enabled for banner text to show.
9. Ensure the **Interface** is set to “Self Service”.
10. Click **Save** on the button bar when complete.

Self-service Banner Style

To customize the Self-service banner style, find the element `.banner-text` in the CSS file and customize it, for example:

```
.banner-text {
  background-color: #515150;
  color: #FFFFFF;
}
```

Minimal Theme Customization

In order to customize the Self-service theme to support the minimal mode, the elements below are available.

Important: If your theme uses a dark colors, the minimal theme may need to be modified to provide a contrasting text and background display.

The examples below are minimal mode image snippets and theme settings:

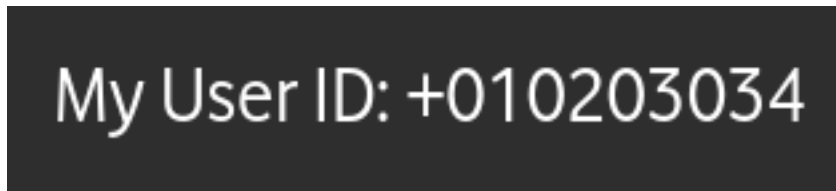

```
.minimal-mode-container {color: white;}
.minimal-mode-container .overlay {background-color: #2e2e2e!important;}
```

- resized logo (<number> variable)
- resized tagline (<number> variable)



```
.logo-holder-header {padding: <number>px <number>px;}
.ss-tagline {height: <number>px; width: <number>px;}
```

- contrasting drop-down menu items and text

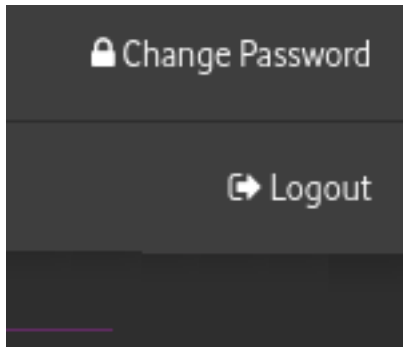

```
.minimal-mode-menu ul {background: #3e3e3e;}
.minimal-mode-menu ul li {border-bottom: 1px solid #2e2e2e;}
.minimal-mode-menu ul li > a {color: white;}
```

13.2.9. Menu Layouts

Menu layouts define the view a user has of the menu content and structure on the Admin Portal; that is, the menu you see when logging in, based on your login user role at the hierarchy where you log in.

Menu layouts can be customized for different levels of the hierarchy. For example, the menu layouts at provider level of the hierarchy can be different to menu layouts at customer level or site level. An administrator with permissions to edit menu layouts can customize a menu layout based on a user's role at a particular level of the hierarchy, to represent the resources the user has access to.

Note:

- To view and edit menu layouts, go to (default menu) **Role Management > Menu Layouts**.
- To view the menu layout assigned to a particular role, go to (default menu) **Role Management > Roles**, click on a role, and view the value in the **Menu Layout** field (this is the menu layout for users with this role).

When creating or editing a menu layout, you can apply a field display policy (FDP) and configuration template (CFT) to refine the view of model entities for the user role. In this way, the FDP and CFT for a specific model is applied as part of the menu layout (in the menu structure); the FDP and CFT are attributes of the specific model entry for that menu layout. This means:

- Different FDPs and CFTs for a specific model can define menu layout variations for that model.
- The required FDP and CFT should be available before you create new menus.

If a menu layout applies to the list view of a model, this list can be filtered by means of a number of filter options that apply to the displayed list. Only instances where the values of a model attribute that match the filter, are then shown.

VOSS-4-UC ships with a number of default menu layouts for the following, hierarchy-based administrator user roles: system admin, provider admin, reseller admin, customer admin, and site admin. You can clone the default menu layouts and edit the settings to create new menu layouts. You can also export a menu layout, edit it externally, and re-import it. For example, you can apply an alternative FDP or CFT, or change the order and grouping of items on the menu layout. Designers with access to tag or version tag can apply these to a menu layout so that it can be uniquely identified to track and control changes.

Related Topics

- Best Practices Guide
- Create a Menu Layout in the Core Feature Guide
- Menu Layout Page in the Core Feature Guide

13.2.10. Best Practices Menus

In addition to a default set of menus, VOSS-4-UC also provides best practice menus for provider and customer administrators, including the associated access profiles and landing pages.

These menus have a more business-oriented structure and include additional options based on best practice adaptations that may also be included in VOSS-4-UC.

The best practice menus have the following features:

- A menu order, nesting and naming convention according to common business use.

The top-down order of the menus follow the logical order of tasks and system hierarchies that are used to carry out these tasks.

For example, for provider administrators, the **Cisco UC App Management** menu provides menus only for these Cisco devices, while SMTP server and other settings carried out by providers are arranged under **Provider Configuration**. Similarly, the **Cisco Subscriber Services** menu has sub-menus for all the functionality associated with these subscribers in VOSS-4-UC.

- Where a menu is for a *form view* (input or edit), the first word in the menu name is in capitals, for example **ADD Internal Number Inventory**. Note that this does not apply to menu names that start with abbreviations and acronyms like E164, HCS, LDAP and so on. In this case, the capital rule will apply to the next word in the menu item name.
- Menus for URLs:
 - Menus are provided for VOSS-4-UC portals so that is easy to launch into another portal.

Important: In the case of menus that use URLs, you need to update the URLs to match your configuration.

To modify and to assign your modification of a best practice menu to a user role, consider the following:

- Managing menu layouts - see: [Create a Menu Layout](#). Also consider using the Menu Diff Tool to easily modify menus - see the Advanced Configuration Guide for details.
- Field Display Policies associated with menu items are available. For further configuration, see: [Add or Edit a Field Display Policy](#).
- Configuration Templates associated with menu items are available. For further configuration, see: [Creating a Configuration Template](#).
- Access Profiles for the best practices menus are provided - see the list under the **Access Profiles** menu. If any access profiles need to be modified to align with a modified menu, see: [Access Profile Permissions and Operations](#).
- Landing Pages for the best practices menus are provided - see the list under the **Landing Pages** menu.

The menus for specific adaptations are listed below. Note that an adaptation may not necessarily be on your system.

Menu	Sub-Menu	3rd level menu	Adaptation
VOSS Phone Server Management	VOSS Phone Server VOSS Phone Adaptive Dial Plan		VOSS Phone Server
Customer Management	Contact Centre Services	<ul style="list-style-type: none"> • CC Users • CC User Preferences • CC User CFTs (with GS_CCUser filter) 	ContactCentre-VoiceRecording User
HCS Dial Plan Management	HCS Dialplan Additions HCS Group CLI	<ul style="list-style-type: none"> • Dialplan Additions • Dialplan Addition Templates • Dialplan Additions CFTs (GS_DialplanAdditions filter) • Dialplan Additions CFTs (ENT_Filter) • CustSCode-PT Translation Patterns • External Group CLI Inventory • External Group CLI Association • Internal Group CLI Inventory • Internal Group CLI Association • ExternalGroupCLI-PT Calling Party Transforms 	Dialplan Additions Group CLI
Site Management	Advanced Site Functions	SameDialplanOB 8XData	Overbuild Same Dialplan AddSite
Number Management	(N to 1) DN to E164 Associations with Update		N to 1 E164 Association Update Support
Number Management	ADD Multi-step Number Inventory		Number Inventory Mgmt - Multi-Step
Cisco Subscriber Services	Add Lines to Pickup Group		Pickup Group Membership
Cisco Subscriber Services	<ul style="list-style-type: none"> • Change Line • Change Line Profiles • Change Line Instance Profiles 		Change Line
Cisco Subscriber Services	Line Recording		Line Recording

Menu	Sub-Menu	3rd level menu	Adaptation
Cisco MACD Functions	<ul style="list-style-type: none"> FAC Code Management Sync FAC Codes Across Clusters 		Enhanced ForceAuthenticationCode Support
Multi- Vendor Services	VOSS Phones		VOSS Phone Server
Audit Tools	VOSS Day 2 Customer Audit Tool		Audit Tool
Overbuild Tools	RUN EM-User Overbuild		Audit Tool
Overbuild Tools	E164 TPs AND TRANSFORM Move Tool		DN Overbuild

13.2.11. Create a Menu Layout

This procedure adds a new menu layout.

Note: When editing an existing menu layout, updates to the menu layout display only once the relevant users have logged out and logged in again.

Perform the following steps:

1. Log in as provider or reseller administrator, or higher.
2. Choose the hierarchy for the new menu layout.
3. Go to (default menu) **Role Management > Menu Layouts**.
4. View existing menu layouts.
 - To create a new menu layout based on settings in an existing menu layout (recommended), click on the menu layout you want to re-use; then, in the editing screen, click the toolbar **Clone** icon to create a new record with pre-populated settings.
 - To create a new menu layout without existing settings, click the toolbar Plus icon (+) to open the **Menu Layouts/New Record** page.
5. On the **Menu Layouts** page, in the **Name** and **Description** fields, fill out a name and a description for the new menu layout.

Note: If you're editing a clone of an existing menu layout, you may need to edit existing settings and add new values for the new menu layout.

6. Add menu items (or edit existing settings for a cloned menu layout):
 - In the **Menu Items** section, click the Plus icon (+) to open the menu layout editing page.
 - Configure the new menu item:
 - Enter a display title and description for the new menu item.

- Optionally, in the **Condition** field, specify a macro to use as a criteria that determines whether the menu and its sub-menus display.

Note: When the macro evaluates to true, the menu and its sub-menus display, else, when the macro evaluates to false, the menu and its sub-menus are hidden. The default is true. The default also applies when no condition criteria is specified. See the following topics in the Core Feature Guide for details: [Menu Layout Page](#), [Macros in VOSS-4-UC](#)

- From the **Icon** drop-down, choose an icon for the menu item.
- From the **Type** drop-down, select the model type to associate with the title you defined (above).
- In the **Href** field, define a link to to be used for external or internal links.

Note: Hrefs are generally recommended for external links. For backwards compatibility, hrefs can be used for links within the application, to link directly to a form:

For example, the Add Phone page would have the following href value: `api/relation/SubscriberPhone/add`

In this case, you will need to use JSON format menu import, or bulk load, to add any associated field display policies (FDPs) and configuration templates for the menu item.

It is recommended that you do not use hrefs to reference `view/` type models.

- Select the **Field Display Policy** and the **Configuration Template** for this menu item.
- From the **Custom Component** drop-down, select the VOSS portal custom component. See: [Custom Components for Menu Layouts and Landing Pages](#).
- From the **Landing Page** drop-down, select the landing page to associate with the menu item.

Note:

- * This option is only available in the new VOSS-4-UC Admin Portal GUI.
 - * Sub-menus cannot be landing pages.
-

- From the **Display As** drop-down, select the display format for this menu item. Options are as follows:

- * List:

Default. If you choose List display, and you've selected a default field display policy and configuration template for the model type, users with a user role associated with the menu layout view the model type based on these options. It is also possible to filter the list view. See [Configurable Filters in Menus and Landing Pages](#).

If you choose List display referenced by type or href, note that a tool (`tool/[toolname]`) can also be presented as a list, for example: `/api/tool/Transaction/?entity=data/Event&operation=execute`

- * Landing Page:

If you choose Landing Page display, you can select an existing landing page, which will display when this menu item is chosen. See [Landing Pages](#) and [Create a Landing Page](#).

Note that this option is *only* is only available if you're using the new VOSS Admin Portal GUI.

* Form:

If you're using href and you choose the Form display, note that the href value points to a model instance with the pkid, for example `data/Countries/5331a739d0278d7893e26d2e`, or ends with `/add/`.

The `view/` model types always open the *Add* form; thus, if used, the value should not have the `/add/` endpoint, for example, as in this JSON:

```
{
  "type": "view/QuickSubscriber",
  "display": "form",
  "title": "Quick Add Subscriber"
}
```

* External Link:

Choosing an External Link display is the recommended use with href, where a URL specified as the href value opens as a new browser tab. You will need to disable pop-up blocking on the users browsers to allow the external link to resolve.

* Tree (if available)

Choosing a Tree display shows a tree view of the resource. When using href with Tree display, the href provides the tree path.

- Configure fixed and configurable filters for the new menu item.
- Click **OK** to add the menu item.
- To add additional menu items, repeat step 6.

The menu items you added display in the **Menu Items** section of the Menu Layouts/New Record page, one per row in the table.

7. To re-order menu items, hold down the hamburger icon in the first column for the relevant row; then drag the menu item to the required position in the table.
8. Click the **Save** icon on the toolbar to add the new menu layout.
9. Assign the menu layout to the appropriate roles.

Related Topics

- Menu Layouts in the Core Feature Guide
- Custom Icon Names Reference in the Core Feature Guide
- Landing Pages in the Core Feature Guide
- Create a Landing Page in the Core Feature Guide
- Menu Layout Page in the Core Feature Guide
- Configurable Filters in Menus and Landing Pages in the Core Feature Guide

13.2.12. Menu Layout Page

This section describes the fields and configuration options on the Menu Layout page.

Note: To open this page, go to (default menu) **Role Management > Menu Layouts**, then click on an existing menu layout to edit it (or to clone it to create a new record based on an existing menu layout), or click the Plus icon (+) on the toolbar to add a new menu layout.

Title	Field Name	Description
Name	name	Mandatory. The name of the menu layout.
Description	description	A description of the menu layout.
Menu Items	menu_items	The list of menu items and -sub items that belong to the menu layout.

Menu Items

The table describes configuration options for the menu items on the Menu Layouts page:

Title	Field Name	Description
Title	title	The menu item title as it will show on the menu.
Condition		Allows you to display/hide a menu and its sub-menus based on a condition specified in the macro. If the macro evaluates to true the menus and sub-menus display, else, when false, the menu and its sub-menus are hidden. The default is True. See the Advanced Configuration Guide for more information about using macros.
Icon		The icon to use for the menu item.
Type	type	The model type to associate with the menu item title.
Href	href	If a direct reference to a model type is used for the menu item, the specified path.
Field Display Policy	field_display_policy	The field display policy to associate with the menu item.
Configuration Template	configuration_template	The configuration template to associate with the menu item.
Custom Components		Admin Portal core custom components. Options in the drop-down depend on the model you choose in the Type field, For example, when choosing model type view/AddPhone, the custom component available for selection is Add Phone . The custom components allow you to display GUI content (such as landing pages, lists, and forms) in the same layout as they appear in the Business Admin Portal. Custom components are also available for multi vendor environments and for Microsoft-only environments. This feature is only available in the new VOSS-4-UC Admin Portal.
Landing Page		The landing page to display, when the Display As option for the menu item is set to Landing Page . This option is only available in the new VOSS-4-UC Admin Portal GUI. Note that sub-menus cannot be selected as landing pages.
Display As	display	The display format of the model types of the menu item. Options are: <ul style="list-style-type: none"> • Form for a single instance • List or Tree for more than one instance • Landing Page for an existing landing page. (This option is available only the new VOSS-4-UC Admin Portal GUI. The default is List .

Filters

The table describes configuration options for Configurable and Fixed Filters on the Menu Layouts page:

Note: Fixed filters cannot be removed.

Title	Field Name	Description
Configurable Filters	filter_options.[n]	For List option only.
Filter By	filter_by	Attributes of the Type can be chosen from the drop-down list.
Filter Type	filter_type	Choose the matching operator for the filter.
Filter String	filter_string	Choose the value that the matching operator should match by.

Related Topics

- [Custom Icon Names Reference](#)
- [Advanced Configuration Guide](#)
- [Menu Layouts in the Core Feature Guide](#)
- [Create a Menu Layout in the Core Feature Guide](#)
- [Configurable Filters in Menus and Landing Pages in the Core Feature Guide](#)
- [Macros in VOSS-4-UC in the Core Feature Guide](#)

13.2.13. Custom Components for Menu Layouts and Landing Pages

The table below provides available custom components for selection when managing menu layouts or landing pages.

- The **Name** value is available from the **Custom Component** drop down list on the menu layout or landing page if the **Type** dropdown matches the **Model Type** in the table.
- If no **Type** is selected in the menu layout or landing page, dashboards in the **Name** column of the table are available.
- The **Route** column can be used for inspection of the component appearance: refer to the URL endpoints of Business Admin Portal menu items that match the **Route** value.

Model Type	Name	Route
view/AddPhone	Add Phone	/phone/add-phone
view/AddSubscriberFromProfile	Add Subscriber	/subscribers/add-subscriber
relation/PexipConference	Add/Edit Conferencing	/conferencing/form-conferencing
relation/SubscriberDeviceProfile	Add/Edit Extension Mobility	/extension-mobility/edit-extension-mobility
relation/HuntGroupRelation	Add/Edit Hunt Group	/hunt-group/edit-hunt-group
relation/Voicemail	Add/Edit Voicemail	/voicemail/edit-voicemail
relation/SparkUser	Add/Edit Webex Teams	/webex-teams/form-webex-teams
view/BulkAddUser	Bulk Add Subscribers	/subscribers/bulk-add-subscribers
	Call Pickup Group Dashboard	/call-pickup-group
	Conferencing Dashboard	/conferencing
	Contact Center Express Dashboard	/contact-center
relation/LineRelation	Edit Line	/number-management/edit-line
relation/SubscriberPhone	Edit Phone	/phone/edit-phone
relation/HcsSiteREL	Edit Site	/site/edit-site
relation/Subscriber	Edit Subscriber	/subscribers/edit-subscriber
	Extension Mobility Dashboard	/extension-mobility
	Headset Dashboard	/headsets
	Hunt Group Dashboard	/hunt-group
view/UserPhoneMoveUsers_VIEW	Move Subscriber	/subscribers/move-subscriber
relation/MultiVendorSubscribers	Multi-Vendor Subscribers List	/subscribers/list-mv-subscribers
	Number Inventory Dashboard	/number-management
	Phone Dashboard	/phone
	Site Management Dashboard	/site
	Subscriber Dashboard	/subscribers
relation/Subscriber	Subscribers List	/subscribers/list-subscribers
	Tools Dashboard	/tools
	Voicemail Dashboard	/voicemail
	Webex Teams Dashboard	/webex-teams

Related Topics

- [Create a Menu Layout](#)
- [Create a Landing Page](#)

13.3. Landing Pages

13.3.1. Landing Pages

A landing page is the page you see when you log in, or when clicking the **Home** button from anywhere in the system.

A default landing page ships with the system, and is associated with pre-defined roles in the hierarchy, for example Provider, Customer, and Site administrators.

Landing pages may be customized for different user roles, and have several configuration options:

- Add shortcut links to frequently used functionality
- Enhance the look and feel on the user's Admin Portal
- Add images and links in vertical or horizontal patterns with unlimited boxes and shortcuts

Editable landing pages provide a way to set up direct links to areas in the system, which can be used as short-cuts by the administrators in line with their role.

Existing images can be used or new images can be added in line with branded look and feel.

You may clone (copy) existing landing pages and then create a new landing page based on pre-populated settings, or the landing page can be exported, edited externally, and then re-imported. Designers with access to the tag function can use tag versions to uniquely identify different landing pages, and to track and control changes.

The CSS of the Theme can be used to control the layout of the landing page.

Related Topics

- [Create a Landing Page in the Core Feature Guide](#)
- [Landing Pages Field Reference in the Core Feature Guide](#)

13.3.2. Create a Landing Page

This procedure adds a new landing page.

Note: To create a new landing page based on settings in an existing landing page, it is recommended that you clone the landing page you want to work with, save it as a new landing page, and edit the settings to create the new landing page.

Perform these steps:

1. Log in as the provider administrator, or higher.

2. Choose the hierarchy level for the landing page.
3. Go to (default menu) **Role Management > Landing Pages**.
4. To create a new landing page based on settings in an existing landing page (recommended), click on the relevant landing page to open its editing screen, then click **Clone**.
5. On the **Details** tab:
 - Define a name for the new landing page.
 - In **Meta Tasks**, click the Plus icon (+), then configure the following: button text, model type, Href, field display policy, configuration template, display format (list or form), and fixed and configurable filters (if required).
 - In **Counters**, click the Plus icon (+), then configure the following: a title for the counter, choose an icon to use, the model type, field display policy, configuration template, and fixed and configurable filters (if required).
 - In **Sections**, click the Plus icon (+), then configure the landing page sections: provide a title, an image URL, and configure links on the landing page:

To configure the links, click the Plus icon (+) for each link you want to add to the landing page, and configure the links:

- Select an icon for the link, and specify the link text.
- If you want the link to display only in some circumstances, you can use a macro in the **Condition** field to define criteria that will show or hide the link. The default is True, which means that if no condition is provided, the link displays, else, use a macro to define when to show or hide the link.
- Select a model type, which will show related field display policies and configuration templates that can be applied.
- In the **Href** field, define a link to be used for external or internal links.

Note: Hrefs are generally recommended for external links. For backwards compatibility, hrefs can be used for links within the application to link directly to a form. For example, the **Add Phone** page would have the following href: `api/relation/SubscriberPhone/add`

In this case, you'll need to use JSON-format landing page import, or bulk load, to add any associated field display policies (FDPs) and configuration templates for the menu item. The recommendation is not to use Hrefs to reference `view/` type models.

- Select a **Field Display Policy** and **Configuration Template**.
- From the **Custom Component** drop-down, select the VOSS portal custom component. See: [Custom Components for Menu Layouts and Landing Pages](#)
- Display As. The link type is displayed as the chosen Display As item:
 - Form: Displays an input form (for an Href resource value other than `view/` models, a resource ends with `/add/`).
 - Inline List: The link points to the first five list of items.
 - List: List view of a resource referenced by Type or Href. If **List** is chosen as the **Display As** type, then the resulting list can also be filtered. See [Configurable Filters in Menus and Landing Pages](#).
 - Tree: A tree view of resource to display (if the system Href provides a tree path).

- If you wish to re-arrange the order of items, click the hamburger icon in the first column and drag items to re-order.
6. On the **Welcome Header** tab:
 - In **Header Text**, provide a single line static welcome message for the top of the landing page.
 - In **Line Text**, provide required line text for the welcome line displayed beneath the header. Use [userrole] as a placeholder to insert the current user's role, to serve as the header. For example /www/img/landingPageIcons/User.png.
 7. Save the landing page.
 8. Assign the landing page to the relevant roles.

Edit a Landing Page

To edit an existing landing page, click on the landing page to open its editing screen. Update settings, and save your changes.

Related Topics

- Landing Pages in the Core Feature Guide
- Landing Pages Field Reference in the Core Feature Guide
- Configurable Filters in Menus and Landing Pages in the Core Feature Guide
- Custom Icon Names Reference in the Core Feature Guide
- Custom Components for Menu Layouts and Landing Pages in the Core Feature Guide

13.3.3. Landing Pages Field Reference

This topic describes the fields and configuration options on the Landing Pages screen in the VOSS-4-UC Admin Portal.

Note: To access this screen (default menus) go to **Role Management > Landing Pages**; then, click on an existing landing page to open the **Landing Pages** editing screen, or click the Plus icon (+) to add a new landing page (which also opens the **Landing Pages** editing screen).

You can select the following tabs on this screen:

- Details tab
- Welcome Header tab

Details Tab

The Details tab defines the following options for the landing page:

- Name: The name of the landing page.
- Meta Tasks
- Counters
- Sections

Meta Tasks

These rows display the shortcut buttons (one or more) at the top of the home page screen (directly below the line text, if configured). Click in the row to edit an existing shortcut button, or click the Plus icon (+) to add a new shortcut button.

The table describes the fields on the Meta Tasks editing screen:

Title	Field Name	Description
Button Text	button_text	Text for the button.
Type	type	The model type to associate with the Title. Blank when href field is populated.
Href	href	API URL. Direct reference to a model type (the path), if applicable. If used, the Type field is empty. Example API URL for a list of items of type relation/SubscriberPhone: /api/relation/SubscriberPhone/
Field Display Policy	field_display_policy	The field display policy associated with the menu item.
Configuration Template	configuration_template	The configuration template associated with the menu item.
Display As	display	The display format of the model types of the menu item. The default is list. <ul style="list-style-type: none"> • Form: (for a single instance) The link opens a form. • Tree: (for two or more instances) • List (for two or more instances)

Counters

These rows display the model-type instance counts (one or more) that display on the landing page. Click in a row to edit an existing counter, or click the Plus icon (+) to add a new counter.

The table describes the fields on the Counters editing screen:

Title	Field Name	Description
Title	display	Mandatory. The title to be displayed for this counter. For example, <i>Phones</i> , <i>Users</i> .
Icon	display	The icon to be used for this counter.
Type	type	The model type to count and associate with the counter.
Field Display Policy	field_display_policy	The field display policy associated with the counter.
Configuration Template	configuration_template	The configuration template associated with the counter.

Sections

These rows display the sections (one or more) that display as blocks on the landing page. Click on an item to edit it, or click the Plus (+) icon to add a new section. Use the hamburger icon to re-order the sections.

The table describes the general fields on the Sections editing screen:

Title	Field Name	Description
Title *	title	Mandatory. The section title as it will show on the Landing page.
Image URL	image	Optional URL to the image to be displayed as section image. For example, let's say a theme is uploaded with landing page images, and the theme folder has a subfolder with the following file: <i>mytheme/img/landingpage/landing1.png</i> In this case, the URL would be: <i>/www/themes/mytheme/img/landingpage/landing1.png</i>
Links	links	List of links (one or more) in the section.

The table describes the fields on the **Links** editing screen:

Title	Field Name	Description
Icon		Choose an icon for the link.
Link Text	link_text	Mandatory. Text for the link.
Condition		Optional. Specify a macro as a condition to define whether the link displays on the landing page. If the macro evaluates to True (default), the link displays. See the Advanced Configuration Guide for more information about using macros as conditional criteria.
Type	type	The model type to associate with the Title.
Href	href	If a direct reference to a model type is used for the menu item, the specified path.
Field Display Policy	field_display_policy	The field display policy associated with the menu item.
Configuration Template	configuration_template	The selected Configuration Template that is associated with the Menu Item.
Display As	display	The display format of the model types of the menu item. The default is list. Default = list. * Form (for a single instance) * Tree (for multiple instances) * List (for multiple instances)
Display Multiple Columns	is_multicolumn	Determines if link is shown as multiple columns or not.

Welcome Header Tab

The table describes the fields on the Welcome Header tab:

Title	Field Name	Description
Header Text	header	A single line static welcome text displayed on top of the landing page.
Line Text	line	Text for the welcome line displayed under the header. Use [userrole] as a placeholder to insert the current user's role.

Related Topics

- Advanced Configuration Guide
- Macros in VOSS-4-UC in the Core Feature Guide
- Create a Landing Page in the Core Feature Guide
- Configurable Filters in Menus and Landing Pages in the Core Feature Guide
- Custom Icon Names Reference in the Core Feature Guide

13.3.4. Configurable Filters in Menus and Landing Pages

Use **Configurable Filters** to open the dialog to enter one or more filter options. If more than one filter is added, this results in a logical AND of the filter application.

- **Filter By** - attributes of the selected Type can be selected from the drop-down list.
- **Filter Type** - select the matching operator to apply when the attribute is matched to the **Filter String** value:
 - Contains
 - Does Not Contain
 - Starts With
 - Ends With
 - Equals
 - Not Equal
- **Filter String** - select the value that the matching operator should match by.
- **Ignore Case** - check box to manage the case of the **Filter String** value.

When the menu item or landing page link is then selected, a pop-up filter box is displayed and the administrator is prompted to apply or modify the filter. If a **Filter String** value is entered on **Configurable Filters**, this value can also then be accepted or modified in the pop up box.

The list view of the results footer row indicates that a filter has now been applied to the list and this filter can then be further modified and removed from the list view as usual - see "Filtering Lists".

Important: Standard list view filters on model types (for example if accessible by other landing pages or menu items) can still be used as described in "Filtering Lists", but these will be removed and replaced by any Configurable Filters on landing page links or menu items for the corresponding model type.

Fixed Filters

Only high-level administrators can add and modify pre-defined **Fixed Filters** to menus and landing pages. For these administrators, this option also shows on the Menu Layout and Landing Page design input forms and presents the same interface options as Configurable Filters.

These filters are not visible to the lower level administrators and will *always* apply when the menu item or landing page link is used by them. Fixed filter results can however be filtered further by Configurable Filters.

13.4. Credential Policy

13.4.1. Customized Credential Policy

A default credential policy called HcsCredentialPolicy ships with VOSS-4-UC. However, you can deploy a customized credential policy at a provider, reseller, or customer hierarchy node.

When you set a customized credential policy as the default credential policy at a hierarchy node, all users and admins at or below that hierarchy node are subject to the customized credential policy, except for any users or admins that are explicitly assigned a different credential policy.

Credential Policy Inheritance

Unless explicitly assigned a credential policy, users and admins are subject to the default credential policy set at a hierarchy node at or above their location. The default credential policy for the hierarchy node closest to the user or admin location is used. If no customized credential policies are deployed, all users and admins are subject to the HcsCredentialPolicy credential policy, which is the default credential policy at the sys.hcs level.

Deploy a Customized Credential Policy

1. Log in as provider, reseller, or customer administrator.
2. Set the hierarchy path to the node where you want to deploy a customized credential policy.
3. Choose **Role Management > Credential Policy**.
4. Either clone the HcsCredentialPolicy credential policy, or add a new credential policy:
 - To clone the HcsCredentialPolicy policy, click **HcsCredentialPolicy**, then click **Action > Clone**.
 - To add a new credential policy, click **Add**. The credential policy settings default to the settings for HcsCredentialPolicy.
5. Provide a name for the credential policy.
6. Modify the credential policy settings as needed.

Field	Description
Idle Session Timeout	The number of minutes a user session can be idle before being automatically logged off. The minimum setting is 1 minute and the maximum is 525600 minutes (365 days). The default is 20 minutes.
Absolute Session Timeout	The number of consecutive minutes a user can be logged in, regardless of session activity, before being automatically logged off. A value of 0 disables absolute session timeout. The maximum is 525600 minutes (365 days). The default is 1440 minutes (24 hours).
Password Expires	The number of months that can elapse between password resets. The default is 6 months.
User Must Change Password on First Login	Select this check box to force users to change their password on initial login. Default = clear.
Lock Duration	The number of minutes a lock will be held when user is locked out. The default is 30 minutes.
Disable Failed Login Limiting per User	Select this check box to not limit the number of times a user can fail to log in before the account is locked. Default = clear
Failed Login Count per User	Selecting this check box will result in user account being disabled if failed login attempt reaches 'Failed Login Count per User' within 'Reset Failed Login Count per User (minutes)'. This field is clear by default.
Reset Failed Login Count per User	After this number of minutes from the last login attempt, the failed login count is reset to 0. The default is 5 minutes.
Disable Failed Login Limiting per Source	Clear this check box to limit the number of times any user from the same IP address can fail to log in before the account is locked. The default is to disable the limit. Note: Do not enable source login rate limiting for a credential policy that will apply to Self Service users. A separate credential policy is recommended for administrators and users that do not use Self Service if source login rate limiting is required.
Failed Login Count per Source	If source login rate limiting is enabled, enter the number of times any user from the same IP address can fail to log in before the IP address is blocked. The default is 10 times.
Reset Failed Login Count per Source	If source login rate limiting is enabled, this value is the number of minutes from the last login attempt from the IP address after which the failed login count is reset to 0. The default is 10 minutes.

Field	Description
Number of Questions Asked During Password Reset	Enter the number of security questions users or admins must answer when resetting their own password with the Forgot Password link. The default is 3.
Password Reset Question Pool	Contains a list of possible security questions that users or admins must answer when resetting their own password with the Forgot Password link.
Password Reuse Time Limit	The number of days from the date the password was created that the password cannot be reused. The valid range is 0-365 days. The default is 15 days. Setting it to 0 disables the reuse time limit.
Minimum Password Length	The minimum length of a password in characters. The minimum allowed value is 8. The default is 8.
Enable Password Complexity Validation	Select this check box to enable the rule on how complex a password must be. The complexity rule requires a password to contain at least one of each of the following: <ul style="list-style-type: none"> • Uppercase letter • Lowercase letter • Digit • Special character (see below)
Inactive Days Before Disabling User Account	The number of days users or admins can go between logging in without having their account disabled. Setting it to 0 disables the inactive time limit. The default is 0.
Session Login Limit Per User	The number of concurrent login sessions a user may have. Setting it to 0 disables the session login limit. The default is 0. If the session limit value is set to 1 or more and the user exceeds the session limit when starting a new session, the oldest login session will be disconnected.
Number of Different Password Character	The minimum number of character changes (inserts, removals, or replacements) required between the old and new passwords.
Minimum Password Age	The number of days within which a user cannot change their password. A zero (0) value means that password age validation is disabled. The minimum value is 1 day and the maximum is 365 days.

Acceptable special characters are:

```
` ~ ! @ # $ % ^ & * ( ) - _ = + [ { ] } | \ \ : ; ' " , < . > / ?
```

Note: It is recommended that you make a credential policy only more restrictive than HcsCredentialPolicy in order to not have a policy that is too insecure.

7. Click **Save**.

Note: If a user is already logged in when the credential policy is changed, changes do not take effect until the user logs out and logs in again.

8. Choose **Role Management > Default Credential Policy**.
9. Provide a name for the Default Credential Policy at this hierarchy node.
10. From the **Credential Policy** drop-down, choose the credential policy you just cloned or added.
11. Click **Save**.

Every user and administrator at or below the hierarchy node is now subject to the default credential policy, unless the user or administrator was explicitly assigned a different credential policy.

Note: Timeout limits will initiate the display of timeout limit notifications in the Admin Portal - see: [Timeout Limit Notifications](#).

13.4.2. Assign a Credential Policy to a User

This procedure assigns a credential policy.

Typically, a user inherits a credential policy from the nearest hierarchy node, at or above their location, wherever a default credential policy is defined. However, you can explicitly assign a credential policy to a user.

1. Log in as provider, reseller, or customer administrator.
2. Go to (default menu) **User Management > Users**.
3. Click the user that you want to assign a credential policy to.
4. On the **Account Information** tab, from the **Credential Policy** drop-down, choose a credential policy to assign.

The menu contains all the credential policies available at or above the user's node in the hierarchy.

6. Click **Save**.

Note: If a user is signed in when the credential policy is changed, changes are not applied until the user signs out and signs in again.

13.4.3. Assign a Credential Policy to an Administrator

This procedure assigns a credential policy to an administrator.

Typically, an administrator inherits a credential policy from the nearest hierarchy node at or above their location, wherever a default credential policy is defined. However, you can explicitly assign a credential policy to an administrator.

1. Log in as provider, reseller, or customer administrator.
2. Go to (default menu) **User Management > Admins**.
3. Click the administrator that you want to assign a credential policy to.
4. On the **Account Information** tab, from the **Credential Policy** drop-down, choose a credential policy to assign.

The menu contains all the credential policies available at or above the administrator's node in the hierarchy.

6. Click **Save**.

Note: If an administrator is already logged on when the credential policy is changed, changes do not take effect until the administrator logs out and logs on again.

13.5. Privacy Policy

13.5.1. Support for Privacy and Security Notices

VOSS-4-UC allows for the configuration of appropriate login security warnings as well as links to cookie and privacy policies for best practice and compliance with regulatory requirements such as General Data Protection Regulation (GDPR).

Support is available on the login screen as well as menus of both the administrator interface and the Self-service application.

- Pop-up login banner

A pop-up banner can be configured for the purpose of security notices or user agreements on the login page after users enter their credentials and when they click the **Login** button on either the administrator interface or Self-service application. Clicking either the **Agree** or **Cancel** buttons remove this pop-up banner.

For details on configuration, refer to [Login Banner](#).

- Privacy and Cookie Policy notices

When drafting cookie policy notices, VOSS-4-UC provides reference content - see: [VOSS-4-UC Cookie Policy](#)

- Login screens: As a part of Theme management, Privacy and Cookie Policy notices can be added on the login interface of both the administrator and Self-service login screens.

For configuration details, refer to : [Set the Login Page Theme and Text on the Legacy Admin Portal](#).

The style of the banner can also be customized. Refer to “Theme Banner Customization” in the “Advanced Configuration Guide”.

- Menu items: High level system administrators above the Provider level hierarchy can manage privacy policy references that are available on administrator and Self-service user menus.

For details, refer to [Privacy Policy Menu Items](#) and [Manage Privacy Policy Menu Items](#).

13.5.2. Privacy Policy Menu Items

In order to comply with General Data Protection Regulation (GDPR) requirements, VOSS-4-UC provides the means to manage privacy policy notices on the user interface.

By default, high level system administrators above the Provider level hierarchy can manage privacy policy references that are available on user menus. These administrators can provide the required access to the `data/PrivacyPolicy` data model and add menus to lower level administrators if required.

Privacy policy references can be set up for each hierarchy. If one is not added to a specific hierarchy, the one at the next higher hierarchy applies.

When a privacy policy applies to a user hierarchy:

- On the Admin Portal, a privacy policy menu item is added to the bottom of the user's menu. The title of the menu item is the name of the created policy.
- On the Self-service GUI (if available), a side button bar menu item is added. The title of the menu item is **Privacy Policy**.

When selecting the menu item, the link URL of the policy opens on a new browser tab.

Note:

- For the Admin Portal, the Privacy Policy menu item is not visible from a menu layout and cannot be managed from **Menu layouts**.
 - Login page privacy policy links are managed from **Themes**. Refer to [Set the Login Page Theme and Text on the Legacy Admin Portal](#).
-

13.5.3. Manage Privacy Policy Menu Items

1. Log in as an administrator with the required privacy policy management permissions and menu access.
2. Choose the menu item, for example by default, **Privacy Policy Configuration**. The list view shows privacy policy names and links at various hierarchies in the system. Privacy policies can then be added, modified and deleted.
3. To add a privacy policy, navigate to the hierarchy at which the privacy policy should be added and click **Add**.
4. Add a Name, Privacy Policy URL and click **Save**. Note that this name becomes the menu item name.

On the Admin Portal, a privacy policy menu item is added to the bottom of the user's menu - for users at the specified hierarchy or lower and without a privacy policy on their own hierarchy. On the Self-service GUI, a side button bar menu item is added.

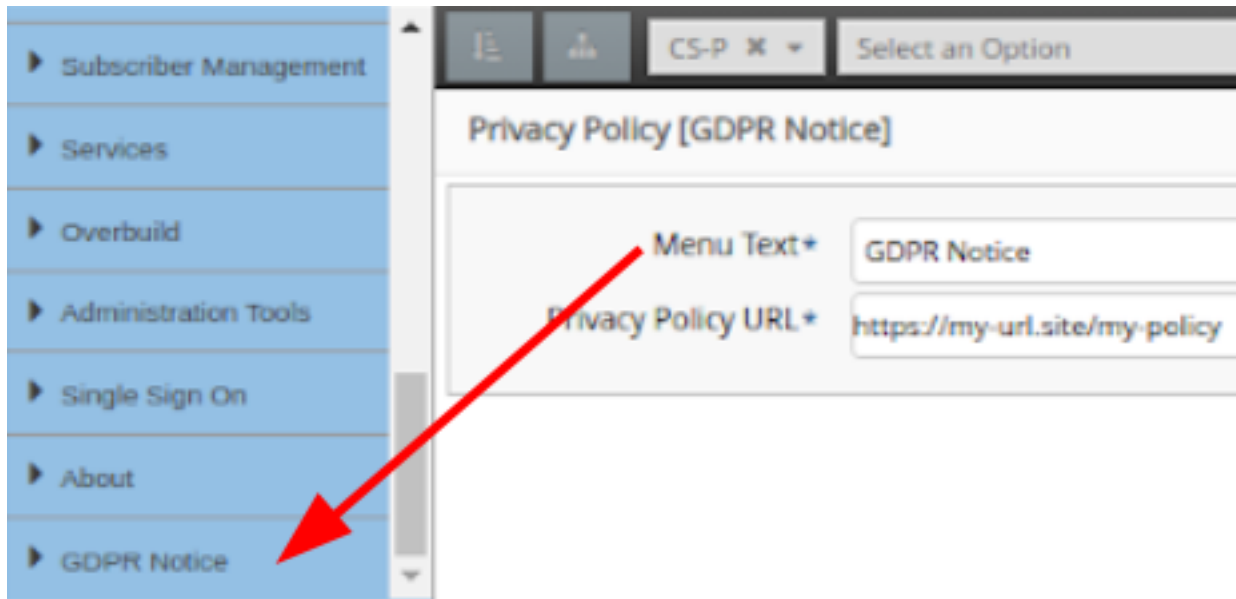

13.5.4. VOSS-4-UC Cookie Policy

When formulating a cookie policy, customers should include details on the use of cookies by VOSS-4-UC. The text below provides details on the use of cookies in VOSS-4-UC that can be included in the policy:

VOSS-4-UC uses cookies **for** the following purposes:

Personalisation - we use cookies to store information about your most recent settings, preferences **and** to personalize our website **for** you.

The cookies used **for** this purpose are:

```
hierarchyTreeSaveStateCookie
resourceTreeSaveSelectedCookie
resourceTreeSaveStateCookie
ace.settings
sso_login_url
```

Security - we use cookies **as** an element of the security measures used to protect user accounts, including preventing fraudulent use of login credentials, **and** to protect our website **and** services generally.

The cookies used **for** this purpose are:

* Administrator login:

```
csrftoken
sessionid
```

* Self-service login:

```
csrftoken
sessionid
session
rbacInfo
```

14. Customizations

14.1. Introduction to Customizations

The system allows a provider administrator (or higher) to customize the Admin Portal user interface.

This customization includes:

- Theme selection
- Menu Layout customization and associated Field Display Policies
- Landing Page customization
- Field Display Policies
- Configuration Templates

14.2. Global Settings

Provider administrators and higher have access to a **Global Settings** customization menu that allows for the configuration of a number of settings across all hierarchies or per individual hierarchy. This topic describes the tabs on the Global Settings page (default menu: **Customizations > Global Settings**)

In the Admin Portal, the read-only value below the drop-down is the current setting (True/False), for options:

- **Inherit** - the service is enabled/disabled based on the setting at the hierarchy above the current one.
- **Yes** - the service is enabled at the current hierarchy.
- **No** - the service is disabled at the current hierarchy.

To change inherited settings, see [How to Change Inherited Settings](#).

14.2.1. Number Inventory Tab

- **Enforce HCS Dialplan Rules:**

When enabled, dial plan workflows enforce HCS Rules when provisioning Customers, Countries, Site and so on. Default = **Inherit**. If your deployment uses a custom or specific dial plan which does not conform to the HCS rules, this setting should be set to **No**.

- **Include the Number Inventory description in all number drop-downs:**

This setting defines whether descriptions for the numbers (which can be added when the number inventory is managed via the **Number Management** menu), display along with the numbers in the drop-down lists. For example, let's say you have a number and its description as follows: *1000 - CEO Internal*. When this setting is enabled (Yes), both the number (1000) and its description displays in the lists (when using features such as Quick Add Subscriber). The default is No.

- **Enable Number Inventory Cooling:**

This setting defines the availability of numbers in the system when a phone, subscriber, or service associated with the number is deleted, and the number is no longer associated with these entities.

The table describes the options for this setting:

Op-tion	Description
In-herit	When set to True, number inventory cooling is enabled or disabled based on the setting defined for number inventory cooling at a higher level in the hierarchy.
True	Enabled, at the hierarchy level you're at. Numbers associated with deleted entities are kept in a cooled state for a specified number of days (based on the value defined in the Number Inventory Cooling Duration (Days) field. Numbers in a cooled state are unavailable in the system until the cooling period end date is reached, unless they are manually released before the end cooling period end date.
False	Default. Number inventory cooling is disabled by default.

- **Number Inventory Cooling Duration (Days):**

When number inventory cooling is enabled (True), this field defines the period (number of days) the number is kept in a cooled state and unavailable for association with a phone user, or service. The default is 30 days.

Related Topics

- Number Cooling in the Core Feature Guide
- Number Cooling Auto Expiry Schedule in the Advanced Configuration Guide

14.2.2. Webex Teams Tab

- **Retain a Webex Teams User when a Subscriber is deleted / Send notification when the Webex Teams Refresh Token expires**

Default is **No** (no message will be sent). Values can be inherited or set as required.

- **Webex Teams Refresh Token expires threshold (in seconds)**

The default (inherited) value is 172800. You can change the value if required.

- **Automatically apply default calling behaviour on Webex Teams user data sync**

Defines whether to apply default calling behavior (configured in customer settings), when syncing users from the Webex Control Hub. The default is **No**. The setting is also selected for the service.

- **Generate and send Webex Teams User CSV file via Webex Teams message**

Defines whether a CSV file is generated and sent as a Webex Teams message. The default is **No**. The CSV file can be imported into Webex Teams Control Hub to update the users.

Example of email message with attached CSV file:

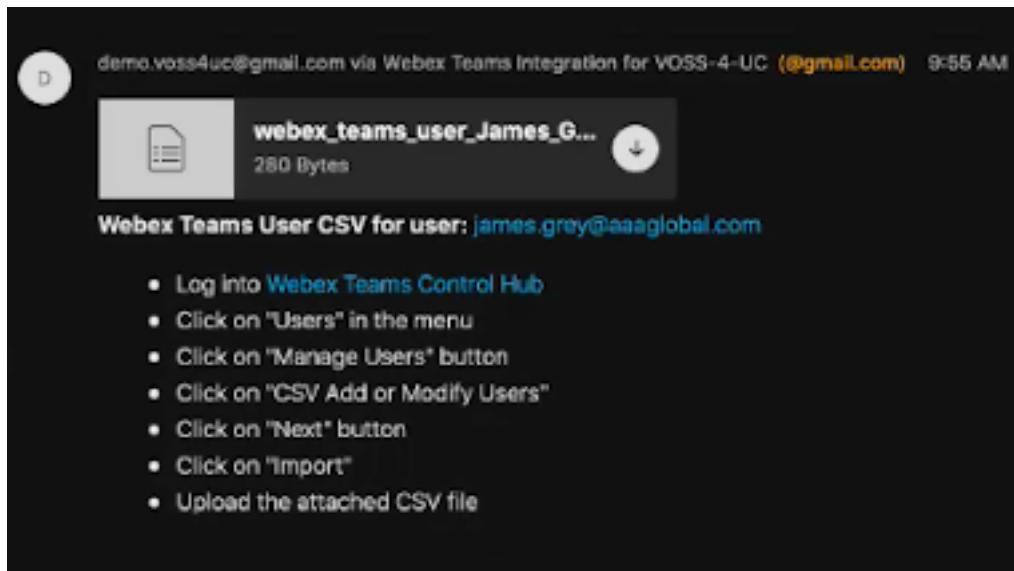

- **Email group containing recipients of the generated Webex Teams user CSV file**

The selected email group: the recipients of the Webex Teams message containing the generated CSV file. The email group can be set up.

- **Send manual Webex Teams Workspace configuration steps via Webex Teams message**

Defines whether manual configuration steps (on Webex Teams Control Hub) are to be sent on creation or modification of a Webex Teams workspace. Default is **No**.

If enabled, the steps will be sent via a Webex Teams message, for example:

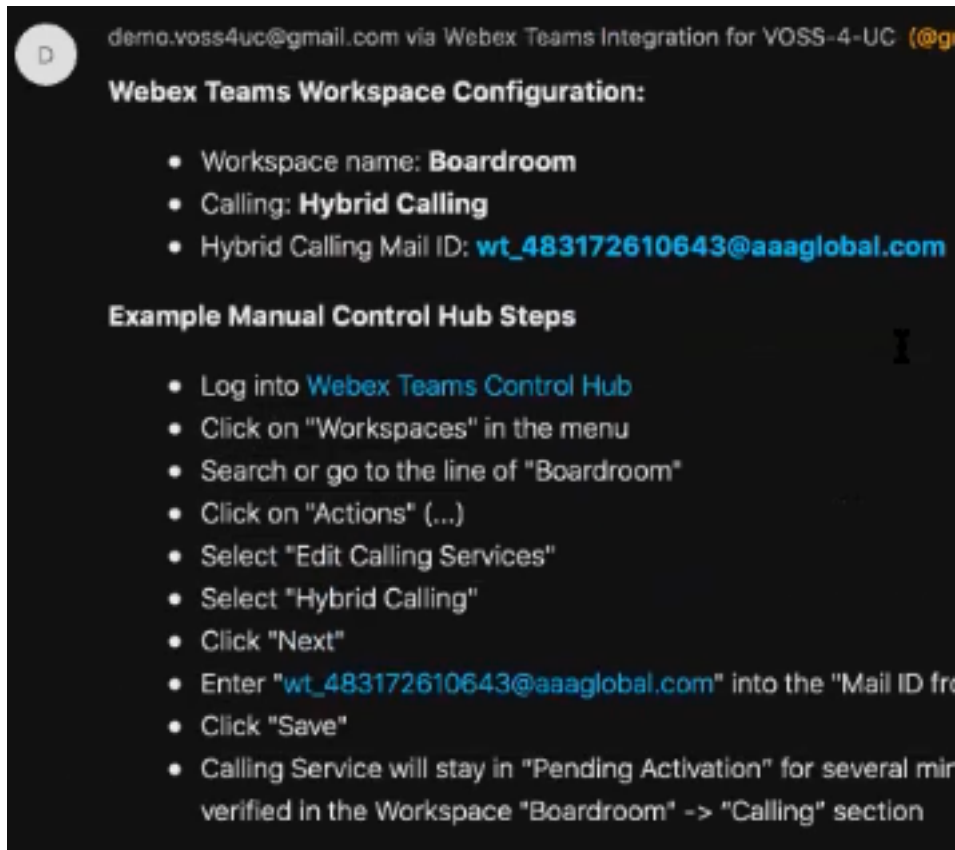

- **Email group containing recipients of the manual Control Hub steps**

The selected email group: the recipients of the Webex Teams message containing the manual configuration steps (on Webex Teams Control Hub). The email group can be set up.

- **Quick Add Group for Hybrid Calling Workspace Unified CM users**

Defines the Quick Add Group to use when creating dummy Unified CM users with line and device for Webex Teams workspace hybrid calling.

Related Topics

- Quick Add Subscriber Group in the Core Feature Guide
- Email in the Core Feature Guide
- Email Groups in the Core Feature Guide
- Create Webex Teams Service in the Core Feature Guide

14.2.3. Pexip Conference

- **Retain a Pexip Conference when a Subscriber is deleted**

Defines whether the Pexip conference set up from the subscriber interface is to be removed when the subscriber is deleted. By default the setting is inherited from the hierarchy level directly above the current one.

14.2.4. Email Tab

- **Allow welcome email to be sent to user after Quick Add Subscriber**

Defines whether an email is sent to a user when added via Quick Add Subscriber. The default is **No**.

When set to **Yes**, and a SMTP server is set up (via the **Apps Management** menu), then selecting the option to send an email when using Quick Add Subscriber, a welcome email is sent to the new subscriber.

Related Topics

- SMTP Server in the Core Feature Guide

14.2.5. Phones Tab

This tab configures the global settings of phones for a site.

Note: *These settings only apply to phones within the same site; both the re-added phone and the existing phone must be on the same site.*

- **Delete existing Unassigned Phone when re-adding an identical Phone**

This setting defines whether you can delete an existing, unassigned phone (that is, a phone without an owner), when re-adding a phone with the same name and type.

The current value for the setting displays below the drop-down. The default is *Inherit* (False). This means that if a phone with the same name and product type is re-added to the system in a Quick-AddSubscriber bulk load or when updating a subscriber, then by default it is not overwritten.

The table describes the global setting options for phones:

Set-ting	Description
Inherit	Default (False). When set to <i>Inherit</i> , the setting is inherited from the hierarchy above the current one.
Yes (True)	Allows you to re-add a phone with the same name and phone type, provided the new phone and the existing phone are on the same site.
No (False)	Does not allow overwrite (replacement) of the existing phone with a phone that has the same name and phone type.

14.2.6. User Tab

When a user is either synced into or added manually on VOSS-4-UC, these settings apply by default. The settings can however be modified when adding a user from the **User Management** menu.

- **User Default Auth Method**

The default authentication method to use a user is synced in or added manually. The default is **Local** (inherited).

Related Topics

- User Authentication Methods in the Core Feature Guide.

14.2.7. Flow Through Provisioning Tab

This tab defines options for sync with flow through provisioning.

- **Enable Flow Through Provisioning:** When enabled, VOSS-4-UC allows for auto-provisioning users and services during user sync from devices. The default is No.
- **Enable Provisioning after Add Sync:** Enables/disables provisioning on LDAP after an add sync completes. The default is No (disabled).
- **Subscriber Criteria:** Defines the default flow through provisioning criteria. See *Flow Through Provisioning Criteria* in the Core Feature Guide.

14.2.8. Enabled Services Tab

This tab defines the global settings for enabling/disabling services for different vendors, such as Cisco or Microsoft. Options are Inherit, or Yes/No (True/False).

When provisioning services from two or more vendors, the global setting is the first of a number of system verification checks. For example, when the **Enable Cisco CUCM** global setting is set to **Yes** (enabled), the administrator can provision a subscriber with new CUCM services (such as a Cisco phone, Jabber, and extension mobility), only if the CUCM device check (server installed), entitlement profile check, and field display policy check all pass the verification check. In the same way, if for example, the **Enable Microsoft** global setting is set to **No** (disabled), and all other checks are set to enabled, existing Microsoft services can be viewed but new Microsoft services cannot be provisioned.

Note: By default, for new installs, the global setting for the following services are inherited from higher levels in the hierarchy (Inherit set to True/enabled):

- Cisco CUCM
- Cisco CUCX
- Cisco WebEx
- Cisco Webex Teams
- Cisco CCX

When upgrading to a version of the system that allows multi-vendor subscribers, the default setting for services other than these 5 services is Inherit (False). To provision services to new subscribers (added after an upgrade), you will need to enable the vendor service in global settings.

Related Topics

- Multi-vendor Subscribers in the Core Feature Guide
- Role-based Access for Multi-vendor Subscriber in the Core Feature Guide
- Configure Multi-vendor Subscribers in the Core Feature Guide

14.2.9. How to Change Inherited Settings

- For numeric inherited values, for example, for “Number Inventory Cooling Duration (Days)” or “Webex Teams Refresh Token expires threshold (in seconds)”, you can overwrite the word “Inherit” with the required value, for example, 45, and save your changes. If the inherited value is already overwritten, for example, the value is already 45, then overwrite this value with the new value.
- For inherited values that are Yes/No (True/False), select an alternative from the drop-down (either Yes, No, or Inherit). This may change the current value.

14.3. Business Admin Portal Profiles

Business Admin Portal profiles (Disabled, default, Read Only, or Full Access) are assigned to user roles via the Business Admin Portal custom interface type (`InterfaceBusinessAdminPortal`), and define the level of access a user has to the following functionality in the Business Admin Portal.

- Features (menus)
- MACDs/Day 2 functionality
- Dashboard widgets, such as charts

The table describes the predefined Business Admin Portal profiles that ship with `InterfaceBusinessAdminPortal`:

Profile	Description
Disabled	A user role with this profile is unable to access the Business Admin Portal.
default	<p>This profile is applied by default to new user roles, at the user's hierarchy level or the first level up. System-level administrators can clone this profile down the hierarchy and modify it to create custom default profiles for the Business Admin Portal interface type.</p> <p>A user role associated with the <code>default</code> profile:</p> <ul style="list-style-type: none"> • Has access to the Admin Portal: Allow switch to Admin mode is enabled. An icon shows in the upper Business Admin Portal interface toolbar to allow switching. If users should not have access, this profile can be cloned to the appropriate hierarchy and the setting can be disabled. • Has no access to the following Business Admin Portal menus: <ul style="list-style-type: none"> – Site management – Tools • Has view access (read-only) to data from other Business Admin Portal menus, including example model counts and charts.
Read Only	<p>The profile applied by default to all operator administrator user roles, with the same permissions as the <code>default</code> profile:</p> <ul style="list-style-type: none"> • No access to the following Business Admin Portal menus: <ul style="list-style-type: none"> – Site management – Tools • Read-only access (view) to data from other Business Admin Portal menus, including example model counts and charts.
Full Access	<p>This profile is applied by default to the provider admin role for new installations. User roles assigned with this profile have full access to all Business Admin Portal menus and features.</p>
MS Only	Select this profile if you have a Microsoft-only environment. In this case, assign this Business Admin Portal profile to user roles that will be used for the Business Admin Portal.

Note: When upgrading to Release 19.1.2 or higher, only the roles at the `sys.hcs` level are updated.

14.3.1. Business Admin Portal Profiles and Field Display Policies

The default Business Admin Portal profile is associated with the following field display (FDP) policies:

- BusinessAdminPhoneFDP
- BusinessAdminLineFDP
- BusinessAdminVoicemailFDP
- BusinessAdminWebexTeamsUserFDP
- BusinessAdminUccxAgentFDP
- BusinessAdminUccxTeamFDP
- BusinessAdminUccxContactServiceQueueFDP
- BusinessAdminHuntGroupFDP
- BusinessAdminCallPickupGroupFDP

These FDPs can be cloned and edited to create new customized FDPs. Or you can create completely new FDPs for the Business Admin Portal profile.

14.3.2. Multi Vendor and Business Admin Portal Profiles

The default FDP for multi vendor scenarios (`MultiVendorFDP`) is not associated with any Business Admin Portal profiles by default. You will need to manually enable multi-vendor for any of the Business Admin Portal profiles, which will then use the multi-vendor FDP.

To enable multi vendor for a Business Admin Portal profile:

1. Log in to the Admin Portal as a provider administrator (or higher).
2. Go to (default menus) **Customizations > Business Admin Portal Profiles**.
3. Click on the relevant profile to open the editing screen.
4. Clone the profile to create a new custom Business Admin Portal profile.
5. On the **Subscribers** tab, select **Enable Multi Vendor**.
6. Save the profile. Allowed features will now be determined via the multi vendor FDP.

14.3.3. Microsoft-Only Business Admin Portal Profile and Field Display Policy

The default FDP for a Microsoft-only scenario (`MS_Only_FDP`) is associated with the default Microsoft-only Business Admin Portal profile, `MS_Only`. This profile may be assigned to user roles that will be used in the Business Admin Portal in a Microsoft-only environment.

Additionally, VOSS-4-UC allows you to (optionally), apply the same look and feel of the Business Admin Portal to the Admin Portal via a custom component.

For user roles that will access the Business Admin Portal in a Microsoft-only environment:

1. Go to **Customizations > Business Admin Portal Profiles**, and edit a cloned version of the `MS_Only` Business Admin Portal profile:
 - On the **Details** tab, select **Enable Business Admin**.

- On the **Subscribers** tab, select **Enable Multi Vendor**, and from **User Details Display Policy**, select the default Business Admin Portal field display policy for Microsoft-only environments, `MS_Only_FDP`.
2. Assign the `MS-only` Business Admin Portal profile to user roles that will use the Business Admin Portal in a Microsoft-only scenario.
 3. Optionally, to apply the same look and feel of the Business Admin Portal to the Admin Portal (new VOSS-4-UC GUI only), go to (default menus) **Role Management > Menu Layouts** and select custom component `list-mv-subscribers`.

14.3.4. Add a Business Admin Portal Profile

This procedure adds a new Business Admin Portal profile.

Perform these steps:

1. Log in to the Admin Portal as a provider administrator (or higher).
2. Go to (default menu) **Customizations > Business Admin Portal Profiles**.
3. Click on an existing Business Admin Portal profile to open its editing screen:
 - If you're using the VOSS-4-UC legacy Admin GUI, click **Actions > Clone**.
 - If you're using the new VOSS-4-UC Admin Portal, click the toolbar **Clone** icon.

Configure the profile

4. On the **Details** tab:

Note: This is the **Base** tab in the legacy Admin GUI.

Interface Business Admin Portal [CS-P]

Base | Dashboard | Site Management | Number Management | Subscribers | Phones

Name* CS-P

Description Default System BAP Profile

Enable Business Admin

Site Management

Number Management

Subscribers

Phones

- Enter a name and description.
- Select **Enable Business Admin** to display the Dashboard tab.
- Select or clear the relevant checkboxes to enable access to menus and other functionality in the Business Admin Portal for this profile. The rest of the tabs on this form are hidden or display depending on whether the relevant checkbox is selected on this tab.
- To add custom features to the Quick Actions card for a feature, click the Plus icon (+) in **Custom Features**; then, configure the custom feature:

Icon	Title	Feature Area	Type	Field Display Policy	Configuration Template	Fixed Filters	Configurable Filters
	Alarms	Dashboard	data/Alert			More...	More...

- Select an icon and an icon title.
- From the **Feature Area** drop-down, select the feature, for example, Extension Mobility, or Phones.
- From the **Type** drop-down, choose a model type.

Note: Similar to menu layout configuration, you'll need to set up additional configuration associated with the model type. The model type must be exposed in the user's access profile, if the custom interface type is associated with a user.

- Choose a field display policy, and a configuration template.
- Click **OK**.

5. On the **Dashboard** tab:

- Enter a title for the dashboard.

- Optionally, select a landing page. When selecting a landing page, the header and line text details on the landing page **Welcome Header** tab display. See Create a Landing page in the Core Feature Guide.
- To select MACDs the admin will have access to on the dashboard, move options from the **Available** transfer box to the **Selected** transfer box.

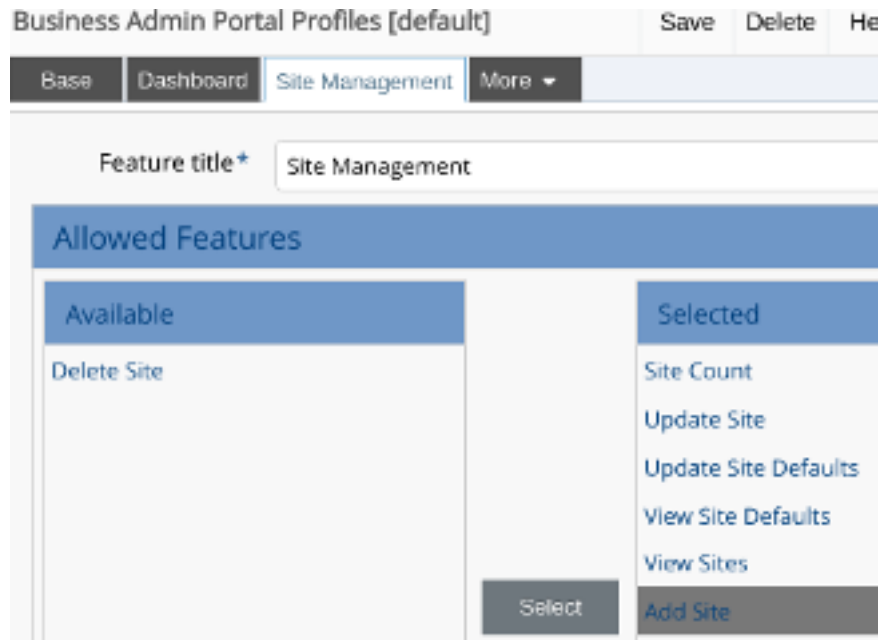

6. On each feature tab you enabled via the **Details** tab, move required options from the **Available** transfer box to the **Selected** box to enable these features on the relevant dashboard.
7. On the **Miscellaneous** tab, configure functionality and display options for the Business Admin Portal:
 - In **Display About Information**, define whether to show or hide the **Settings > About** menu.
 - To display the **Export** action on the lists and forms, enable **Allow Data Export**; else, clear the field (disable).
 - To display options such as Replay and Cancel on the transaction instances and the list view, enable **Transaction Log Actions**; else, clear the field (disable).
 - To display options for showing and hiding selected information on the transaction when viewing a transaction instance, such as logs and sub-transactions, enable **Transaction Log Display Fields**; else, clear the field (disable).
8. On the **Subscribers** tab, configure functionality available on subscriber dashboards. Available options are defined via the User Details Display Policy you choose.
 - To enable multi vendor, select **Enable Multi Vendor**. The multi vendor subscriber field display policy (default name: MultiVendorFDP) is applied. To change any fields and available functionality, edit `MultiVendorFDP`, via (default menus) **Customizations > Field Display Policies**.
 - To disable multi vendor, clear the **Enable Multi Vendor** checkbox. In this case, the Subscribers landing page will now display a count card for both subscribers (total number of provisioned users) and for end users (total number of end users).
9. Save the profile.

A provider level admin can assign the new profile and the `InterfaceBusinessAdminPortal` interface type when adding or updating a user role.

14.3.5. Related Topics

- Multi Vendor Subscribers in the Core Feature Guide
- Assign a Business Admin Portal Profile to a Role in the Business Admin Portal Guide
- Add and Edit Roles in the Core Feature Guide

14.4. Subscriber Profiles

Subscriber profiles allow you to group a number of services and resources into a profile that you can assign to a subscriber via Quick Add Group (QAG) templates. The subscriber profile is added to the QAG along with other configuration settings.

Subscriber profiles are used in the Admin Portal and in the Business Admin Portal.

Important: A *Default* subscriber profile is created at sys (System) level. Only a system level administrator may delete the system-level default profile. To add a new subscriber profile, it is recommended that you clone (create a copy) of an existing subscriber profile and create the new profile based on a valid (working) QAG.

Subscriber Profiles Field Reference

The table describes options for configuring subscriber profiles:

Field	Description
Entitlement profile	Select an entitlement profile to define the resources and services that may be assigned to a subscriber.
Quick Add Group	The quick add group (QAG) defines the configuration templates to be used during service provisioning. These quick add groups are also used for Quick Add Subscriber (QAS).
Voice	Assigns voice services. When enabled, a desk phone is created. The phone template in the QAG defines the phone type. When voice is disabled in the profile, the following fields are hidden on the Business Admin Portal Subscriber page: <ul style="list-style-type: none"> • Use generated phone name • Phone Name
Extension Mobility	The template in the QAG defines settings for extension mobility. The extension mobility template defines the device types available in the drop-down, and the selected device types define the available configuration settings. The default for Line is the first subscriber line. Subscriber details define the values in Line Label and Line Display . Only one device profile can be added for extension mobility in VOSS-4-UC. If a subscriber is associated with two or more extension mobility profiles on the Unified CM, and you sync with VOSS-4-UC, only the first extension mobility profile displays on the Subscribers list view in VOSS-4-UC.
Voicemail	Assigns voicemail service for the profile. When enabled, and the service is added, the subscriber can be added as a voicemail user.
Webex Meetings	Allows Webex service.
Webex Teams	A Webex Teams user profile may be chosen for the profile. In this case, the user profile defines the Webex Teams service that will be provisioned. When Webex Teams is enabled for the subscriber profile, the subscriber can be added as a Webex Teams user when the service is added.
Contact Center Express	When enabled, an agent profile may be chosen for the profile. In this case, you also need to choose the device type to use as the agent's controlled device. When adding the service, the subscriber default extension displays, as well as (depending on the selected controlled device type - phone or extension mobility), the subscriber's phone or device profile.

Field	Description
Single Number Reach	Choose whether to include single number reach (SNR) service for the profile. Only one remove destination profile may be added for single number reach. If a mobile number has already been configured for a subscriber, it is used to pre-populate the Mobile Number field when adding SNR for that subscriber. You can enter a different mobile number for SNR, if required.
Jabber	Choose whether to include Jabber service, and one or more Jabber device types.
Microsoft	Allows Microsoft services. Selecting this checkbox displays the Hosted voice mail and Enterprise voice enabled options for Microsoft subscribers.
Hosted voice mail	Allows Microsoft hosted voicemail service to be provisioned.
Enterprise voice enabled	Allows Microsoft Enterprise voice service to be provisioned.

Subscriber Profiles [Default]

Name*

Description

Entitlement Profile

Quick Add Group*

Voice

Extension Mobility

Voicemail

Webex Meetings

Webex Teams

Pexip Conferencing

Contact Center Express

Single Number Reach

Jabber

Microsoft

Hosted voice mail

Enterprise voice enabled

Related Topics

- Voicemail in the Business Admin Portal Guide
- Webex Teams in the Business Admin Portal Guide
- Contact Center Management in the Business Admin Portal Guide

14.5. Configuration Mapping for Phones, DeviceProfiles, and Lines

Configuration mapping is available for higher level administrators as a part of the overall configuration as well as for other purposes.

The table describes the purpose of configuration mapping:

Type	Purpose
For phones and device profiles	<ul style="list-style-type: none"> • Define the phones types available for selection. • Define the configuration settings used when a specific phone type is selected. • Allow multiple configurations, for example, different button templates for the same phone type. • Provide business-friendly names for different phone type configurations, rather than CUCM-defined names. For example: “Executive Phone with 2 lines”. • Make use of phone-type-agnostic configuration templates (CFTs), allowing for the management of fewer CFTs in the system rather than a CFT for each phone type.
For lines, phones and device profiles	Define a set of feature templates for use by lower-level administrators, and customize the configuration of the applicable item. This allows you to have different versions of configuration, as required.
For soft phones (specifically)	Provide CFTs to manage the process of moving the soft phones of subscribers.

14.5.1. Phone Configuration Mapping

There may only be one phone configuration mapping at any hierarchy. This phone configuration mapping must be `Default`.

Mapping Profiles

The mapping profiles define the list of phone types that can be selected, and includes:

- Profile name
- Profile items: Phone type, Protocol, Button template, Security profile
- Base configuration template (CFT)

	Profile Name	Phone Type	Protocol	Button Template	Security Profile	Base Configuration Template	
☰	Cisco 7841	Cisco 7841	SIP	Standard 7841 SIP	Cisco 7841 - Standard SIP Non-Secure Profile	Basic Phone CFT	+
☰	Cisco 7841-2 Lines	Cisco 7841	SIP	Standard 7841 SIP-2 Line	Cisco 7841 - Standard SIP Non-Secure Profile	Basic Phone CFT	+

The value in the **Profile Name** field is presented to the lower-level administrator user in **Phone** drop-downs in the Admin Portal.

For example, if the administrator selects “Cisco 7841”, then:

- The phone is provisioned as a “Cisco 7841” SIP device
- The phone will have a button template called *Standard 7841 SIP*
- The phone will have a security profile called *Cisco 7841 - Standard SIP Non-Secure Profile*
- The phone configuration will come from a basic CFT called *Basic Phone CFT*

🏠 / Phones / Add Phone

Phone Details

Device Type * ⌵ 🔍

Phone Description

Phone Name *

Phone Template 🔍

Standalone Phone

Filter (contains) 🔍

- Cisco 7821
- Cisco 7841
- Cisco 7841-2 Lines
- Cisco 7861
- Cisco 7861-3 Lines
- Cisco 8811

Note: The *Base Configuration Template* and the *Feature Configuration Template* may also contain profile item fields such as **Phone Type** and **Protocol**. In this case, the order of precedence for the values is:

1. Feature Configuration Template

2. Base Configuration Template
3. Profile items

For example, a phone type specified in the **Phone Type** field under **Profiles** is superceded by the phone type specified in the *Base Configuration Template* or the *Feature Configuration Template*.

Feature Templates

The **Feature Templates** section of the Phone and Device Profile configuration mapping allows a higher-level administrator to configure a list of *Feature Configuration Template* CFTs, providing different configurations to complete the setting of the phone, device profile or line.

The image shows the list of available Feature templates:

Feature Templates			
	Template Name	Feature Configuration Template	
☰	Default	Default Phone Feature CFT	⊕
☰	CS-P Updated CFT	CS-P Phone Template BAP	📄 🗑️

The Feature templates are presented to the lower-level administrator as the list of templates (phone, device profile or line) that can be chosen when adding either a phone, extension mobility, or line. The *Feature* templates will contain the additional configuration settings that are applied on top of the settings mentioned above.

🏠 / Phones / Add Phone

Phone Details

Device Type * ▼ 🔍

Phone Description

Phone Name *

Phone Template Default ▼ 🔍

Standalone Phone

Filter (contains) 🔍

CS-P Updated CFT

Default

Macros for Phone Configuration Mapping

The table describes the available context macro variables when defining configuration templates for the phone mappings:

Macro	Description
<code>{{ input.standalone }}</code>	Flag whether it is a standalone phone or being associated with a subscriber.
<code>{{ input.username }}</code>	Username of the subscriber the phone is being associated with. Only when standalone is false.
<code>{{ input.device_type }}</code>	The user selected device type. This in fact is the phone mapping profile name.
<code>{{ input.template_name }}</code>	The user selected feature template.
<code>{{ input.name }}</code>	The user entered phone name.
<code>{# input.lines #}</code>	The user entered list of lines.
<code>{{ input.lines.0.directory_number }}</code>	The number of the first line.
<code>{{ input.lines.0.template_name }}</code>	The user selected line template.
<code>{{ input.lines.0.label }}</code>	The user entered line label.
<code>{{ input.lines.0.display }}</code>	The user entered line display.
<code>{{ pwf.user }}</code>	Object containing all UCM user settings of the associated subscriber. Only when standalone is false.

14.5.2. Device Profile Configuration Mapping

There may only be one device profile configuration mapping at any hierarchy, and the name of this mapping (at any hierarchy) must be `Default`.

The setup for device profile configuration mapping is identical to the phone configuration mapping. The phone type list and *Feature** templates are presented to the administrator when adding an extension mobility service to a subscriber via the Subscriber Management page. See *Feature Templates* under [Phone Configuration Mapping](#).

Please enter details for the new Extension Mobility profile. ✕

Name *

Device Type * ▼

Extension Mobility Profile Template ▼

Line Template ▼

Line * ▼

Line Label

Line Display

14.5.3. Line Configuration Mapping

There may only be one line configuration mapping at any hierarchy, and this line configuration mapping (at any hierarchy) must be `Default`.

A list of line templates can be configured and these will be presented to the administrator when new lines are created, for example when adding a new phone.

Macros for Line Configuration Mapping

The table describes the available context macro variables when defining configuration templates for the line mappings:

Macro	Description
<code>{{ input.userid }}</code>	User ID for description.
<code>{{ pwf.PassedLine.pattern }}</code>	Line pattern description.
<code>{{ input.firstName }}</code>	User first name for Alerting name or ASCII Alerting name.
<code>{{ input.lastName }}</code>	User last name for Alerting name or ASCII Alerting name.
<code>{{ input.Phone.0.lines.line.0.dirn.pattern }}</code>	The destination.

The table describes the named macros that can be used when defining configuration templates for the line mappings. High-level administrators with access to `data/Macro` can inspect and evaluate these named macros to verify result values. For details on Configuration Template customizations, see the Advanced Configuration Guide.

- For `callingSearchSpaceName`

```

{{ macro.CUCM_LINE_callForwardAll_callingSearchSpaceName }}
{{ macro.CUCM_LINE_callForwardAlternateParty_callingSearchSpaceName }}
{{ macro.CUCM_LINE_callForwardBusyInt_callingSearchSpaceName-2 }}
{{ macro.CUCM_LINE_callForwardBusyInt_callingSearchSpaceName }}
{{ macro.CUCM_LINE_callForwardNoAnswer_callingSearchSpaceName }}
{{ macro.CUCM_LINE_callForwardNoAnswerInt_callingSearchSpaceName }}
{{ macro.CUCM_LINE_callForwardNoCoverage_callingSearchSpaceName }}
{{ macro.CUCM_LINE_callForwardNoCoverageInt_callingSearchSpaceName }}
{{ macro.CUCM_LINE_callForwardNotRegistered_callingSearchSpaceName }}
{{ macro.CUCM_LINE_callForwardOnFailure_callingSearchSpaceName }}
{{ macro.CUCM_LINE_callForwardOnFailure_callingSearchSpaceName }}

```

- For presenceGroupName

```

{{ macro.CUCM_LINE_presenceGroupName }}

```

- For routePartitionName

```

{{ macro.CUCM_LINE_routePartitionName }}

```

- For secondaryCallingSearchSpaceName

```

{{ macro.CUCM_LINE_callForwardAll_secondaryCallingSearchSpaceName }}

```

- For voiceMailProfileName

```

{{ macro.CUCM_LINE_vmprofile }}

```

Line Configuration Mapping [Default]
Save Delete Help Back Action

Name*

+ Line Templates

	Template Name *	Configuration Template *
+ - o o	<input type="text" value="Default"/>	<input type="text" value="Default CUCM Line Template"/>

14.6. Dropdown Filters

Administrators with access to the **Dropdown Filters** menu can manage the items available in dropdown lists on input forms. A filter would typically be used to define a shorter dropdown list.

Filters can be added, removed, modified and two existing filters can also be merged to define a new filter.

The Dropdown Filter list macro name that is generated starts with `DDF__` and is of the format (dots and slashes replaced by underscores):

```
DDF__<target model type> __<target model name>_<target field>
```

This is also the name shown in the **Dropdown Filters** list view at the hierarchy at which it was created.

14.6.1. Add a Dropdown Filter

1. Navigate to the required hierarchy.
2. Select the **Dropdown Filters** menu and click **Add**.
3. Choose **Create a Dropdown Filter** From the **Select a Dropdown Filter Action** dropdown list.
4. Choose the **Target Model** and **Target Field** names to which the filter is to be applied.

This is the dropdown field on an input form on the Admin Portal. Click **Help** on the input form to see the names.

5. Identify the associated **Model Type** and **Dropdown Field** of the **Dropdown Filter specifications**.

This can differ from the form names. Click **Help** on the input form to verify.

6. Set up the **Filter Fields**. Compare a **Filter Field** to a **Filter Field Value**:

- contained in or not contained in
- equal or not equal

Note that:

- The **Filter Field** can differ from the **Target Field**. In other words, the dropdown list can be filtered according a filter applied to *another* field that belongs to the **Model Type**.
- The **Filter Field value** can also take the *name* of a named macro that resolves to a value, for example: `macro.SITENAME`.

7. Add **Additional Parameters** to the filter:

- `direction:hierarchy` direction for search: `[up|down|local|parent|below|above]` (`below` and `above` exclude current hierarchy)
- `device`: device name
- `ndl`: network device list that the device belongs to
- `limit`: number of results
- `skip`: start number of results - can be used for paging
- `title`: character or regular expression: only return values matching its value

For details and examples, refer to the topics on macro syntax in the Advanced Configuration Guide.

8. Click **Save**. A dropdown filter is created.

This filter is a named list macro that will be added to the GUI Rule which is in place at the selected hierarchy for the **Target Field** on the Admin Portal input form of the selected **Target Model Name**.

When a created dropdown filter is opened, the macro is shown in the **Macro** field at the bottom of the form. Users who have menu access to the list of named macros can also see the dropdown filter macros by filtering the list by name starting with `DDF__`.

14.6.2. Example of a Dropdown Filter

Consider the filter:

- **Target Model Name:** `relation/LineRelation`
- **Target Field:** `callForwardAll.callingSearchSpaceName`
- **Model Type:** `device/cucm/Css`
- **Dropdown Field:** `name`
- **Filter Field:** `name`
- **Filter Condition:** `Contains`
- **Filter Field Value:** `Cu2`
- **Additional Parameter: Parameter Title:** `Direction`
- **Additional Parameter: Parameter value:** `up`

The list macro that is created applies to the GUI rule for the input field `callForwardAll.callingSearchSpaceName` of the input form for `relation/LineRelation` at the selected hierarchy. The list macro would then be:

```
{# device/cucm/Css | name /Cu2/i | direction: up #}
```

If you have access to the Macro Evaluator, you can test this macro. Also refer to the topic on Macro Syntax in the Advanced Configuration Guide for more details.

In the **Dropdown Filters** list view at the hierarchy, the **Filter Name** shows as:

```
DDF__relation_LineRelationTarget_callForwardAll_callingSearchSpaceName
```

14.6.3. Merged Dropdown Filters

Two existing dropdown filters can be merged to create a new dropdown filter. The merged filter is a dropdown list that uniquely combines the lists from the two dropdown filters.

14.6.4. Merge Dropdown Filters

1. Navigate to the required hierarchy.
2. Select the **Dropdown Filters** menu.
 - Check that the two dropdown filters that you want to merge are showing in the list view at the hierarchy. Otherwise, add the dropdown filters.
3. Choose **Merge Existing Dropdown Filters** from the **Select a Dropdown Filter Action** dropdown list.
4. Choose the **Target Model** and **Target Field** names to which the filter is to be applied.
5. Choose the two dropdown filters from the **Dropdown Filters to merge** form.
6. Click **Save**. A merged dropdown filter is created.

Note: Only two filters can be merged.

If you wish to merge more than two dropdown filters, first create a merged filter of each filter pair and select it to be merged.

When a created merged dropdown filter is opened, the macro is shown in the **Macro** field at the bottom of the form. The macro uses the `fn.list_extend_no_dup` macro function to uniquely merge the two dropdown filter lists. The macro syntax is of the format

```
{ { fn.list_extend_no_dup macro.DDF__<filter name 1>, macro.DDF__<filter name 2> } }
```

Refer to the topic on Macro Syntax and List Functions in the Advanced Configuration Guide for more details.

14.7. Line Delete Preferences

When deleting a phone, device profile or remote destination profile from VOSS-4-UC, the line or lines (Cisco Unified CM lines) in use by the phones or devices are not automatically deleted.

Line Delete Preferences provides the ability, for a reseller administrator (or higher) to control whether the lines are deleted when deleting the phone or device, or updated (using values contained in a specified configuration template).

A new menu (default = **Customizations > Line Delete Preferences**) allows the configuration of the following:

- Allow deletion of a line
- Allow update of a line
- Configuration template to use for update (if enabled)

When:

- a phone, device profile or remote destination profile is deleted
- a line is deleted or changed from a phone, device profile or remote destination profile

then the following logic applies:

Allow Line Deletion if unused

- If the line is not shared with another phone or device, the line will be deleted and the number inventory updated.
- See also [Delete Lines](#).
- If the line exists on another phone belonging to the same user as the deleted device, no action is taken.

Allow Line Update after Device Deletion

- If the line is not shared with another phone or device, the line is updated with the details from the selected configuration template.
- If the line is shared with another phone or device belonging to another user, the line is updated with the details from the selected configuration template specified in **Line Update Configuration Template name**.
- If the line is shared with another phone or device belonging to the same user, then no update is performed.

Note: To determine the user associated with a phone, the owner ID must be set on the deleted phone.

Affected Models

- Model Type: device/cucm/Phone
 - Operation: Delete
 - Phase: Post Execution
 - Workflow: LineDeletion_PhoneDataSync_PWF
 - Synchronous: False
- Model Type: device/cucm/DeviceProfile
 - Operation: Delete
 - Phase: Post Execution
 - Workflow: LineDeletion_PhoneDataSync_PWF
 - Synchronous: False
- Model Type: device/cucm/RemoteDestinationProfile
 - Operation: Delete
 - Phase: Post Execution
 - Workflow: LineDeletion_PhoneDataSync_PWF
 - Synchronous: False

14.8. Field Display Policies

14.8.1. Field Display Policies

Field Display Policies are applied to certain item types in order to modify the default form that is displayed when these items are created or accessed.

With Field Display Policies, the fields on an item detail form can be grouped, disabled, and on-line help text can be added for a field. A field can be provided with a new label and its position on the form can be moved up or down.

More than one Field Display Policy can apply to a particular item type so that the selection of a particular policy will present another view of the form.

A Field Display Policy for an item type can be applied from a Menu Layout by selecting and associating it with the item on the Menu Layout. The Menu Layout is then selected to be part of a user Role so that users who have this role and log in will be able to have the item displayed according to the relevant Field Display Policy.

For example, a system may have users at Provider, Customer and Site administration hierarchy levels - all of whom may access the same items, but perhaps some item fields need to be hidden for administration users at a certain level. Field Display Policies can then be made that are applied to the Menu Layout associated with the administration users at these levels.

A quick way to add a Field Display Policy is to clone an existing Field Display Policy, modify it as required and then to select it for the model on a user's menu layout. In this way a user's interface can be modified from the point of user access to the model on the menu.

There is a unique constraint on the name of the Field Display Policy per hierarchy level. The same name can be used on another hierarchy, but a new name is needed at the same hierarchy.

If a Field Display Policy is called `default`, it will apply to a model by default.

Note: The list view column header will also show the field title from the Field Display Policy if the field belongs to the list of summary attributes.

Related Topics

- Multi-vendor Subscriber Field Display Policy in the Core Feature Guide
- Add or Edit a Field Display Policy in the Core Feature Guide

14.8.2. Rules When Creating a Field Display Policy

When creating groups and selecting the field transfer boxes of a group, a number of rules apply.

Regarding notation: if the fields belong to objects or arrays, the names in the transfer boxes are shown in dot notation. Refer to the target model type on-line help field reference to distinguish object types from array types.

To understand the rules below, consider a selected Target Model Type with the fields as listed below. Where the name starts with "A", the field is an array and where it starts with an "O" it is an object. The values "x", "y", "z" are also objects. The field "F" is neither object or array.

- A, A.x, A.x.b, A.x.c, A.x.d, A.y.r, A.y.s, A.y.t
- F
- O, O.v, O.z, O.z.a, O.z.b, O.w.d

The following inclusion rules apply:

- If a parent object or array field is included, the parent and all its children will be displayed in the GUI. For example, if O.z is selected, O.z is saved as the fields and the GUI will display O.z and also inner fields O.z.a and O.z.b.
- If a specific selection and order of child elements are required, select these child elements and order them. For example, if O.w.d, O.z.b, F are selected, these three fields are saved in that order in the FDP group fields and the GUI shows only the inner field O.w.d, followed by the inner field O.z.b and lastly the field F.
- Inclusion of child fields in a group without the inclusion of the parent fields will display these child fields at the root level of the form. For example, if O.w.d, O.z.b are selected, these fields are saved as is in the FDP group fields list and only the inner fields O.w.d and O.z.b are shown in the GUI.
- Array children fields without their parent fields will be ignored by the GUI. Therefore, if the child fields of an array field are selected, the parent field should also be selected. For example, if A.y.s, A.y.t are selected, A and A.y should be selected.
- Array fields may not be split into different groups.

- The parents of fields cannot be in one group and its children in another. For example, O.z cannot be in Group 1 if O.z.a, O.z.b and O.w.d are in Group 2.
- Fields of the same object and members of the same array type cannot belong to more than one group. For example:
 - If A.y.s is selected for Group 1, then A.y.t cannot be selected for Group 2.
 - If O.z.a is selected for Group 1, then O.z.b cannot be selected for Group 2
- You can split the first level children of object fields into different groups. For example:
 - O.v can be in Group 1 while O.z is in Group 2.
 - For second level children: O.z.a can be in Group 1 and O.w.d can be in Group 2.
- To hide a field, do not move it to a Selected box. For example, to hide O.z.b, select O.z.a, O.w.d.

To order fields in a group, arrange them in the Selected box. Use the **Move Up** and the **Move Down** buttons under the box.

The following ordering rule applies:

The ordering of child fields and their parents depend on the presence of siblings, other parents and children. If a child is selected in a group and not its parent, but a sibling of that parent is selected, then the sibling's order will affect the order of the fields.

The logic of order resolution starts from parents to children, according to the rules below.

For example, we select fields in this order in Group 1:

C.z, A.x.b, A.x.c, B, A.y, A.x, C, C.w

Result:

- Parent fields on their own are considered first, hence our initial order is B, C.
- However, parent A is not selected; only the children. We determine where A was mentioned. In this case the children of parent field A were mentioned before the parent fields B or C. Hence children of A will eventually be ordered before B and C.
- Next we consider the selected first level child fields: C.z, A.y, A.x, C.w. The order becomes: A.y, A.x, B, C, C.z, C.w
- We now move down the levels: A.x.b, A.x.c.

Thus the final display order will be:

A.y, A.x, A.x.b, A.x.c, B, C.z, C.w

Further examples below illustrate the presence of parents, siblings and children on the selected order.

- We add fields C.w, A, C, B, A.x, A.y.

Result: The order is: A, A.x, A.y, C, C.w, B.

- We add fields A.x.b, A.x.c, A.y, A, B

Result: The order is: A, A.x, A.x.b, A.x.c, A.y, B.

Note that A.x was added and that A.y is placed after A.x, since the children were ordered before A.y while A.x was never selected.

Related Topics

- Field Display Policies in the Core Feature Guide

14.8.3. Clone a Field Display Policy

1. Login as provider administrator or higher.
2. Choose the desired hierarchy.
3. Choose **Customizations > Field Display Policies** to show the list of existing Field Display Policies.
4. Click on the field display policy that you want to clone.
5. Choose **Actions > Clone**.
6. Update the necessary fields for the cloned Field Display Policy. Refer to “Rules When Creating a Field Display Policy” for more information.
7. Click **Save**.

The cloned Field Display Policy is available to be applied to the item by selecting it in a Menu Layout that is available to a Role.

14.8.4. Add or Edit a Field Display Policy

This procedure adds and edits a field display policy (FDP).

Note: To modify the default form available for an item, a field display policy can be added to Data models, Relations, and Views.

Perform the following steps:

1. Login as provider administrator or higher.
2. Choose the relevant hierarchy.
3. Choose **Customizations > Field Display Policies** to view existing field display policies.
4. To edit an existing field display policy, click on the relevant field display policy and update the configuration, as required.
5. To add a new field display policy, click **Add** on the toolbar, and configure the following:
 - a. In the **Name** field, enter a name for the new field display policy.
 - If the name is `default`, the field display policy is applied to the target model type by default.
 - Each field display policy at the same hierarchy level must have a unique name. Field display policies at different hierarchies can share the same name.
 - b. Optionally, enter a description.
 - c. At **Target Model Type**, choose a model reference.

The target model type defines the fields available for use in the field display policy.

- d. At **Groups**, click the plus icon (+), then configure the following:

All fields in the field display policy must belong to a group.

Component	Description
Title	Mandatory. Enter the label text to display for the attribute on the new tab. If a group displays as a tab in the Admin Portal, the value defined for Title displays as the title of the tab.
Display as Fieldset	Select this check box to display the group header and fields as a fieldset on the same page in the Admin Portal (not on a separate tab). Alternatively, if two or more groups have this checkbox enabled, the group title displays on a tab called Base .
Number of Columns	Enter a numeric value to define the number of columns. The default is a single column. Fields in the Selected transfer box display in these columns.
Fields	Choose fields to add. Select fields from the Available box and add them to the Selected box. The target model type you choose defines the available fields. Use the Move Up/Move Down buttons to adjust the position of any field.

- e. At **Field Overrides**, click the plus icon (+), then configure the following:

This step configures fields added to the **Selected** transfer box.

Component	Description
Field	Select the field.
Title	Define the label text. If the field display policy is called <code>default</code> at a hierarchy, the list view column header also displays this title if the field belongs to the list of summary attributes.
Help Text	Enter the text to display as the field online help and form tooltip. Alternatively, leave the field blank to use the model attribute description.
Disabled	Select this check box to display the field as disabled (unavailable).
Input Type	Select an option to choose how the input field displays.

6. Click **Save**. If you're editing an existing field display policy, your changes are saved. If you're adding a new field display policy, the policy is created and is available for applying to the item by selecting it in a menu layout available to a role.

See Also:

- Field Display Policies in the Provider Core Feature Guide
- Rules When Creating a Field Display Policy in the Provider Core Feature Guide
- Field Display Policy Input Reference in the Advanced Configuration Guide

14.8.5. Field Display Policy Field Reference

Title	Field Name	Description
Name *	name	The name that is given to the Field Display Policy.
Description	description	A description for the Field Display Policy.
Target Type Model *	target_type_model	The target model type to which the Field Display Policy applies.
Groups	groups.[n]	The groups that describe groupings of attributes that are displayed together on the user interface.
Title *	title	The name of a specific group of attributes.
Display as Fieldset	display_as_fieldset	Render this group as a fieldset in the form.
Number of Columns	num_cols	The number of columns of fields.
Fields	fields.[n[]]	Model fields that will form part of the particular group.
Field Overrides	field_overrides.[n]	Field display policy overrides to apply to a model fields.
Field *	field	Name of the model field to override.
Title	title	New title to display for field.
Help Text	help_text	New help text to display for field.
Disabled	disabled	Will set the field to read-only if checked.
Input Type	input_type	Overrides the input type of the field.

14.9. Configuration Templates

14.9.1. Configuration Templates

Configuration templates are used to define values for attributes of any model. The values can be fixed values or existing macros visible from the hierarchy context where the configuration template is applied. The templates provide a useful way to define default values for items that are exposed in the Admin Portal (visible, invisible or read-only). They also provide a mechanism to map data from data input via the Admin Portal or device model events to other models or Provisioning Workflows in the system.

One may want to hide attributes of a model while setting them to a specific fixed value (for example a hard-coded setting); or one may wish to derive the value based on a macro (for example, look up the value based on data in the system).

For example, if a model has an attribute that is defined to be a date string, a Configuration Template for the attribute can be defined as a macro `{{fn.now \"%Y-%m-%d\"}}` in order to set the current date stamp as the value, such as 2013-04-18. Designers can access reference material for details on macros.

Another example is a model such as the Quick Add Subscriber that limits the user input to a few fields, whilst deriving the value of other hidden attributes from various Configuration Templates that are each applied to different underlying models that make up a Subscriber (for example, Voicemail account settings, conference account settings, phone, line, device profile settings, and so on).

When an instance of the model is added or updated, the Configuration Template that has been enabled for the model applies. For array elements of data models, a list and a variable can be specified to be looped through so that a value is applied to each element in the model array.

More than one Configuration Template can be created for a model. These can then be used as needed. Configuration Templates can also be applied to models in the design of for example Provisioning Workflows.

A Menu Layout that can be associated with a user role can also apply a Configuration Template to a model that is selected as a menu item.

For administrators at Provider Administrator level or higher, a quick way to create a Configuration Template would be to open a similar template from for example the **Configuration Templates** menu and to customize a clone of it.

Administrators at levels above the Site Administrator can also customize these templates, including Field Display Policies.

Note:

- When modifying Configuration Templates via the Admin Portal, numerical values need to be entered using the `fn.as_int` function, for example:

```
{{ fn.as_int 14 }}
```

- In a multi-cluster environment, Configuration Templates that result in device model drop-down lists on the Admin Portal may contain duplicates. Any duplicated item can be selected by the user.
-

14.9.2. Creating a Configuration Template

This procedure clones and edits an existing configuration template to create a new configuration template.

Perform these steps:

1. Log in as Provider Administrator or higher.
2. Go to **Customizations > Configuration Templates** to display the list of existing templates.
3. Click the template that you want to clone, and view the template information that displays.
4. Click **Action > Clone**.
5. Edit the required generic template fields, such as **Name**, **Description**, **Target Model Type**, and the fields specific to the selected model type. See Configuration Template Field Reference in the Core Feature Guide.

Note: Some fields are populated based on specific conditions. For example, when creating a device instance configuration template in a multi device or clustered environment, the values in drop-downs in the template that originate from a device will be the values from *all* the devices in the cluster. For this reason, the list may include duplicates, but in such a case, any duplicate may be chosen if required.

6. Click **Save**. The new, cloned template appears at the selected hierarchy level.

Example: Create a template for the Cisco 6941 SCCP Phone

1. Enter the hierarchy where the Cisco Unified Communications Manager you want to use exists. This step is required if the fields are to populate values because some of the values are derived from the actual device model through the API.

2. Click the **Default CUCM Phone Template**, and then click **Action > Clone**.

Note: Do not click **Save** yet.

3. Change the template **Name** and **Description**.

4. Edit the template fields:

- From the **Device Protocol** drop-down, choose **SCCP**.
- From the **BAT Phone Template** drop-down, choose **Standard 6941 SCCP**.
- From the **Device Security Profile** drop-down, choose **Cisco 6941 - Standard SCCP Non-Secure Profile**.
- From the **Product** drop-down, choose **Cisco 6941**.
- From the **BLF Presence Group** drop-down, choose **Standard Presence Group**.
- In the remaining fields, use the cloned default values.

Tip: If you know the values for the fields, you can type the files in the fields instead of selecting the values from the list.

5. Click **Save**.

Configuration Template Field Reference

The table describes general fields on the Configuration Template editing screen:

Note: Fields specific to the template for the selected target model type are not included in the table.

Title	Field Name	Description
Name *	name	The name that is given to the Configuration Template.
Description	description	A description for the Configuration Template.
Foreach Elements	foreach.[n]	Iterates over the list returned by the macro and appends array elements to the specified field.
Property *	property	The field property to iterate over.
Macro List *	macro_list	The macro that produces the list to iterate over.
Context Variable *	context_var	The context variable that will contain the data from the iteration.
Schema Defaults	schema_defaults.[n]	Applicable only when the configuration template is used directly in API requests. This attribute contains a list of paths to the properties of the template section that must be used to enrich the default values of the schema. All paths specified must refer to array attributes.
Target Model Type *	target_model_type	The target model type and name that the Configuration Template applies to.
Merge Strategy	merge_strategy	Determines how this CFT will be merged into another CFT when it is being processed in a PWF. Default: additive.
Template *	template	The contents of the template, such as defaults and macros. The names shown in the template are determined by the attribute names of the Target Model Type.

14.10. Email

14.10.1. SMTP Server

A SMTP server can be configured via the **Apps Management** menu at the relevant hierarchy to allow VOSS-4-UC to send email messages.

Email functionality is available for the following:

- Quick Add Subscriber (QAS)

When email is enabled in the Global Settings (Email tab), you can select a checkbox on QAS to send a welcome email to new subscribers added via QAS.

- File Transfer Destinations

Configured by high level system administrators to to transfer audit data for licensing. See the Licensing and Subscriber Data Export Guide.

Add a SMTP Server

This procedure adds a SMTP server at a hierarchy level.

Prerequisites:

- Enable emails in the Global Settings (Email tab).

Perform these steps:

1. Log in to the Admin Portal, at the hierarchy where you wish to add a SMTP server.

Note: You may only set up one SMTP server at each hierarchy level. Hierarchies below the hierarchy where the SMTP server is set up can use the SMTP server at the hierarchy above; that is, sites can use the SMTP server set up at the customer level.

2. Go to (default menus) **Apps Management > SMTP**.
3. Click the toolbar Plus sign (+) to add a new SMTP server.
4. On the SMTP Server form, configure details for the new SMTP server:
 - Add name for the SMTP server, and a description for the email account.
 - Enter the SMTP server hostname and port number.
 - Select **Secure** to use the SSL protocol for establishing a connection to the SMTP server.
 - Enter username and password credentials for establishing a connection to the SMTP server.

Related Topics

- Email in the Core Feature Guide

14.10.2. Email

Provider administrators can test email messages and manage email templates, if an email SMTP server is set up, and when emails are enabled via the Global Settings (Email tab). See: [SMTP Server](#) and [Global Settings](#).

Send Test Email

This option allows for an email message to be sent from and to a specified email address and by selecting an email HTML template to test in the email body.

Email HTML Templates

Email templates contain placeholders for the email subject and body text, which is in HTML markup. The HTML markup and can be modified as required (for example by using an external WYSIWYG HTML editor).

To modify a template for a specific hierarchy, clone the default to the hierarchy.

When adding a HTML template from the list view, the **Name** can only be “Test Email Template” or “Quick Add Subscriber”.

By default, the following email templates are provided:

- Test Email Template
 - Clone this template to your hierarchy if you want to customize it.
 - The HTML template name “Test Email Template” cannot be changed.
- Quick Add Subscriber
 - This template is used if the setting is enabled in **Global Settings**.
 - Clone this template to your hierarchy if you want to customize it.
 - The HTML template name “Quick Add Subscriber” cannot be changed.

Values from the Quick Add Subscriber input form can be used to populate the template by adding variables to the HTML template. The following variables are available for the template:

Field name on input form	Variable available in HTML
Username:	{{ pwf.EMAIL.username }}
First name:	{{ pwf.EMAIL.firstname }}
Last name:	{{ pwf.EMAIL.lastname }}
One time password:	{{ pwf.EMAIL.password }}
One time PIN:	{{ pwf.EMAIL.pin }}
Access Code:	{{ pwf.EMAIL.phone_access_code }}
Email:	{{ pwf.EMAIL.email }}
Extension:	{{ pwf.EMAIL.extension_number }}
Mobile Number:	{{ pwf.EMAIL.mobile_number }}
Entitlement Profile:	{{ pwf.EMAIL.entitlement_profile }}
Phone Type:	{{ pwf.EMAIL.phone_type }}
Phone Names:	{{ pwf.EMAIL.phone_names }}
Jabber Device Names:	{{ pwf.EMAIL.jabber_names }}
Extension Mobility Name:	{{ pwf.EMAIL.extensionmobility_name }}

Therefore, you can for example include user details as follows in your HTML template:

```
<p>Username: {{ pwf.EMAIL.username }}</p>
<p>First name: {{ pwf.EMAIL.firstname }}</p>
<p>Last name: {{ pwf.EMAIL.lastname }}</p>
```

Email Groups

A list of email addresses can be added to a group defined by the value entered in the **Name** field.

This group can then be referenced in settings where email messages are used and an email group can be specified as the recipient, for example in the **Global Settings** for Webex Teams to specify recipients of generated CSV files.

Related Topics

- [SMTP Server](#)
- [Global Settings](#)

15. Dial Plan Management

15.1. Introduction

Important: Contact your dedicated VOSS support representative for details on how to set up and configure the next generation dial plan management feature.

Note: If this feature is not exposed in the Admin Portal menu layout, refer to the Optional Features Appendix: Dial Plan Management - Menu Layout Changes and Access Profile Changes.

The VOSS-4-UC next generation dial plan management feature:

- Offers dial plan management that is independent of the hierarchy schema approach of the first generation dial plan management. However, the feature can also be used in together with schema-based dial plan management.
- Enables senior administrators to define complete complex dial plans and to allow the application of these to lower level administrators without the need to understand the complete dial plan.
- Can be used in place of the schema or schema group approach or in tandem with this approach, for example to add elements in an additional dial plan in an ad-hoc manner.
- All the available functionality of schemas are covered by the models of the feature, as well as call routing via route filters.
- Provides additional benefits:
 - More configuration options
 - A repeatable process to manage Cisco Call manager elements
 - Dial plan can be provisioned in a modular manner
 - A structure to store dial plan models

15.1.1. Scope

The following areas of Cisco Dial Plan deployment are covered by this feature:

- Device Pools - Regions - Locations -SRST
- Transcoders
- Conference Bridge
- Media Resource Groups
- Media Resource Group Lists
- Route Groups
- SIP Trunks
- CTI Route Points *with Lines* (Lines are not supported in schemas)
- Time Periods
- Time Schedules
- Partitions
- CSSs
- Route Patterns
- Transition Patterns
- Called Party Transformation Patterns
- Calling Party Transformation Patterns
- SIP Route Patterns

The entire group of dial plan elements is referred to as a “Dial Plan Model”. Each dial plan element is broken into its own container or model for storage in VOSS-4-UC. This allows for simple management of the dial plan model as a whole. The dial plan models may be bulk loaded into VOSS-4-UC and managed via the Admin Portal.

15.2. Dialplan Management Menu

The Dial Plan Management menus provide access to enhanced dial plan management functionality:

- **Dial Plan Maintenance** - an interface for the created dial plan to be push to or removed from a chosen, **Target Call Manager Cluster**.

The hierarchy on which this operation is carried out will filter the list of dial plans - according to the chosen **Dial Plan Type** when it was created on the **Dial Plan Models** menu.

This utility can also be used to push a dial plan to the cluster for inspection and then to remove it again, as long as no elements were added to the Call Manager cluster that rely on the dial plan elements (for example, adding phones on the Call Manager that would lock CSSs and partitions).

- **Dial Plan Viewer** - a tabbed form view of all the dial plan elements of a selected dial plan created from this feature. The contents of this view corresponds with the view of a dial plan schema, but in a format that is easier to inspect. Note that the viewer does not allow for any changes to be made to the dial plan. See also “Dial Plan Models” for details of each specific dial plan element.

- **Delete Dial Plan Model** - from this menu, an entire dial plan created in this feature can be deleted with a single action, in other words, all dial plan model elements associated with the selected dial plan model are removed, as well as the dial plan model itself.

- **Dial Plan Input Data** - an interface allowing lower level administrators to easily set up data to be added to either global or site level dial plan types. Custom dial plan data can also be included.

In the individual dial plan elements, the values entered here are then referenced with macros, so that shared dial plan data can be managed efficiently.

- **Dial Plan Models** - a list of menus to manage elements of dial plans created with the feature. Individual elements such as Route Patterns, SIP Trunks, and Translation Patterns each have a menu item from which it can be managed.
- **Dial Plan Log** - a record of Push and Remove operations carried out from the **Dial Plan Maintenance** menu. Details such time and hierarchy of operation, target Call Manager and dial plan name are recorded.

This interface provides an overall view and does not allow any editing of the dial plan.

15.3. Dial Plan Maintenance

The Dial Plan Maintenance View is the mechanism by which dial plan is manipulated on Call Manager instances. There are no restrictions on the use of this tool from a hierarchy perspective. The naming of the dial plans should indicate at what level the dial plans may be used. There is an enhancement in place to tag dial plans in the dial plan model with Global/Site/No Specific Type so that a small amount of error checking can be introduced into this tool.

The dial plan tag allows only dial plans meant for a specific hierarchy use to be shown in the dial plan maintenance tool. For example, If an administrator is at customer level in VOSS-4-UC and uses the dial plan drop-down, the list of available dial plans are only those tagged "Global". We do this to ensure the dial plan models with hierarchy specific macros are executed at the correct hierarchy levels.

Push Dial Plan Mode

Dp Maintenance View		Save	Help	Back	Action ▼
Tool Description	Dial Plan Maintenance Tool				
Notes	This tool allows you to Push Dial Plan elements to Customer and Site level. The tool can add and remove dial plan elements from Call Manager. To remove dial plan element those element must not be locked by an other informix relationships in Call Manager.				
Hierarchy level	sys.hcs.VLS.Tenant1.Vancouver				
Dial Plan Name*	Site_Level_DP ▼				
Target CUCM*	["10.5.25.21", "8443"] ▼				
Operation	Push Dial Plan ▼				

Remove Dial Plan Mode

Dp Maintenance View		Save	Help	Back	Action ▼
Tool Description	Dial Plan Maintenance Tool				
Notes	This tool allows you to Push Dial Plan elements to Customer and Site level. The tool can add and remove dial plan elements from Call Manager. To remove dial plan element those element must not be locked by an other informix relationships in Call Manager.				
Hierarchy level	sys.hcs.VLS.Tenant1.Vancouver				
Dial Plan Name*	Site_Level_DP ▼				
Target CUCM*	["10.5.25.21", "8443"] ▼				
Operation	Remove Dial Plan ▼				

Both modes of the tool work in the same manner:

1. A dial plan model is chosen from the **Dial Plan Name** drop-down.
2. A target CUCM is chosen from the **Target Call Manager Cluster** drop-down.
3. A operation is chosen from the **Operation** drop-down.

15.4. Multi-Cluster Dial Plan Maintenance

In contrast with the *Dial Plan Maintenance* view, the **Multi-Cluster Dial Plan Maintenance** allows for a selected Dial Plan to be added to or removed from multiple Unified CM Clusters in a single step.

15.4.1. Procedure

Both modes of the tool work in the same manner:

1. Choose the **Dial Plan Name** to manage on the Unified CM clusters.
The dial plan tag allows only dial plans meant for a specific hierarchy use to be shown. The **Chosen Dial Plan Type** shows this.
2. An operation is chosen from the **Operation** drop-down.
3. Select the Unified CM clusters from the **Available** transfer box so these are shown in the **Selected** box.
4. Click **Save** to carry out the task.

15.4.2. Notes

- All dial plan elements are added to or removed from the selected clusters in accordance with the selected operation.
- The operation's transaction log sub-transactions **Detail** column show dial plan, hierarchy and target cluster.
- If for example a site level dial plan is selected, this tool will check the Unified CM of the Network Device List (NDL) belonging to the site to verify if a dial plan is applied to this Unified CM.
- Sites cannot be excluded if a site level dial plan is applied. in the cluster.

15.5. Dial Plan Input Data and Macros

15.5.1. Overview

The input forms from the **Dial Plan Input Data** simplifies the update of dial plan data by exposing a set of values that can be provided to and then easily applied by lower level administrators.

No values are mandatory, and Field Display Policies can be used to hide unused fields if needed (for example, **Secondary SIP Trunk Destination IP** and **Secondary SIP Trunk Destination Port**).

In addition, a set of custom values can be added and macros are available so that these can be referenced in dial plan elements. (A Field Display Policy can then be used to rename the input field label if needed.)

Two types of dial plan input data can be defined, each corresponding to a dial plan type:

- **Global Data:** applies to Global dial plan type (customer)
- **Site level Data:** applies to Site dial plan type

Input data may be used in combinations to build patterns dynamically, because the pattern itself is a macro.

For example, site level translation patterns for 7 or 10 digit dialing can use the Customer Level macro for PSTN access (or External Breakout Number), then followed by a “.”, then the macro for Area Code or Exchange:

```
{{ macro.DP_Global_PSTNAccess }}.{{ macro.DP_AreaCode }}XXXXXXX
```

when applied, could be inserted to Call Manager as 9.214XXXXXXX for 10 digit dialing.

```
{{ macro.DP_Global_PSTNAccess }}.{{ macro.DP_Exchange }}XXXX
```

when applied, could be inserted to Call Manager as 9.256XXX for 7 digit dialing.

15.5.2. Global Dial Plan Data Single Instance

Data from the provided fields may be referenced with the provided macros:

- Custom Customer ID: {{ macro.DP_Global_CustomCustID }}
- External Breakout Number: {{ macro.DP_Global_PSTNAccess }}
- Published Number: {{ macro.DP_Global_PNum }}
- Emergency Call Back Number: {{ macro.DP_Global_ENum }}
- Area Code: {{ macro.DP_AreaCode }}
- Exchange: {{ macro.DP_Exchange }}

15.5.3. Global Aggregation SIP Input Data Tab

Dp Global Dial Plan Data Save Help Back

Dial Plan Data | Aggregation SIP Input Data | Custom Dial Plan Data

Primary SIP Trunk Destination IP	<input style="width: 100%;" type="text" value="{{ macro.DP_Global_PrimarySIPAddr }}"/>
Primary SIP Trunk Destination Port	<input style="width: 100%;" type="text" value="{{ macro.DP_Global_PrimarySIPPort }}"/>
Secondary SIP Trunk Destination IP	<input style="width: 100%;" type="text" value="{{ macro.DP_Global_SecondarySIPAddr }}"/>
Secondary SIP Trunk Destination Port	<input style="width: 100%;" type="text" value="{{ macro.DP_Global_SecondarySIPPort }}"/>

Data from the provided fields may be referenced with the provided macros:

- Primary SIP Trunk Destination IP: `{{ macro.DP_Global_PrimarySIPAddr }}`
- Primary SIP Trunk Destination Port: `{{ macro.DP_Global_PrimarySIPPort }}`
- Secondary SIP Trunk Destination IP: `{{ macro.DP_Global_SecondarySIPAddr }}`
- Secondary SIP Trunk Destination Port: `{{ macro.DP_Global_SecondarySIPPort }}`

15.5.4. Global Custom Dial Plan Data Tab

Dp Global Dial Plan Data Save Help Back

Dial Plan Data | Aggregation SIP Input Data | Custom Dial Plan Data

Dial Plan Custom Value 1	<input style="width: 100%;" type="text" value="{{ macro.DP_Global_CVal01 }}"/>
Dial Plan Custom Value 2	<input style="width: 100%;" type="text" value="{{ macro.DP_Global_CVal02 }}"/>
Dial Plan Custom Value 3	<input style="width: 100%;" type="text" value="{{ macro.DP_Global_CVal03 }}"/>
Dial Plan Custom Value 4	<input style="width: 100%;" type="text" value="{{ macro.DP_Global_CVal04 }}"/>
Dial Plan Custom Value 5	<input style="width: 100%;" type="text" value="{{ macro.DP_Global_CVal05 }}"/>
Dial Plan Custom Value 6	<input style="width: 100%;" type="text" value="{{ macro.DP_Global_CVal06 }}"/>
Dial Plan Custom Value 7	<input style="width: 100%;" type="text" value="{{ macro.DP_Global_CVal07 }}"/>
Dial Plan Custom Value 8	<input style="width: 100%;" type="text" value="{{ macro.DP_Global_CVal08 }}"/>
Dial Plan Custom Value 9	<input style="width: 100%;" type="text" value="{{ macro.DP_Global_CVal09 }}"/>
Dial Plan Custom Value 10	<input style="width: 100%;" type="text" value="{{ macro.DP_Global_CVal10 }}"/>

Data from the provided fields may be referenced with the provided macros:

- Dial Plan Custom Value 1: `{{ macro.DP_Global_CVal01 }}`
- Dial Plan Custom Value 2: `{{ macro.DP_Global_CVal02 }}`

- Dial Plan Custom Value 3: {{ macro.DP_Global_CVal03 }}
- Dial Plan Custom Value 4: {{ macro.DP_Global_CVal04 }}
- Dial Plan Custom Value 5: {{ macro.DP_Global_CVal05 }}
- Dial Plan Custom Value 6: {{ macro.DP_Global_CVal06 }}
- Dial Plan Custom Value 7: {{ macro.DP_Global_CVal07 }}
- Dial Plan Custom Value 8: {{ macro.DP_Global_CVal08 }}
- Dial Plan Custom Value 9: {{ macro.DP_Global_CVal09 }}
- Dial Plan Custom Value 10: {{ macro.DP_Global_CVal10 }}

15.5.5. Site Dial Plan Data Single Instance

Dp Site Dial Plan Data Save Help Back

Dial Plan Data Aggregation SIP Input Data Custom Dial Plan Data

Custom Site ID: {{ macro.DP_Site_ID }}

External Breakout Number: {{ macro.DP_Site_PSTNAccess }}

Site Location Code: {{ macro.DP_Site_SLC }}

Published Number: {{ macro.DP_Site_PNum }}

Emergency Call Back Number: {{ macro.DP_Site_ENum }}

Dial Plan Model for Site:

Local Area Codes

Dial Plan Pattern:

Type:

Area Code: {{ macro.DP_AreaCode }}

Exchange: {{ macro.DP_Exchange }}

Data from the provided fields may be referenced with the provided macros:

- Custom Site ID: {{ macro.DP_Site_ID }}
- External Breakout Number: {{ macro.DP_Site_PSTNAccess }}
- Site Location Code: {{ macro.DP_Site_SLC }}
- Published Number: {{ macro.DP_Site_PNum }}
- Emergency Call Back Number: {{ macro.DP_Site_ENum }}
- Area Code: {{ macro.DP_AreaCode }}
- Exchange: {{ macro.DP_Exchange }}

15.5.6. Site Aggregation SIP Input Data

Dp Site Dial Plan Data Save Help Back

Dial Plan Data | Aggregation SIP Input Data | Custom Dial Plan Data

Primary SIP Trunk Destination IP:

Primary SIP Trunk Destination Port:

Secondary SIP Trunk Destination IP:

Secondary SIP Trunk Destination Port:

Data from the provided fields may be referenced with the provided macros:

- Primary SIP Trunk Destination IP: `{{ macro.DP_Site_PrimarySIPAddr }}`
- Primary SIP Trunk Destination Port: `{{ macro.DP_Site_PrimarySIPPort }}`
- Secondary SIP Trunk Destination IP: `{{ macro.DP_Site_SecondarySIPAddr }}`
- Secondary SIP Trunk Destination Port: `{{ macro.DP_Site_SecondarySIPPort }}`

15.5.7. Site Custom Dial Plan Data Tab

Dp Site Dial Plan Data Save Help Back

Dial Plan Data | Custom Dial Plan Data

Dial Plan Custom Value 1:

Dial Plan Custom Value 2:

Dial Plan Custom Value 3:

Dial Plan Custom Value 4:

Dial Plan Custom Value 5:

Dial Plan Custom Value 6:

Dial Plan Custom Value 7:

Dial Plan Custom Value 8:

Dial Plan Custom Value 9:

Dial Plan Custom Value 10:

Data from the provided fields may be referenced with the provided macros:

- Dial Plan Custom Value 1: `{{ macro.DP_Site_CVal01 }}`
- Dial Plan Custom Value 2: `{{ macro.DP_Site_CVal02 }}`
- Dial Plan Custom Value 3: `{{ macro.DP_Site_CVal03 }}`
- Dial Plan Custom Value 4: `{{ macro.DP_Site_CVal04 }}`

- Dial Plan Custom Value 5: {{ macro.DP_Site_CVal05 }}
- Dial Plan Custom Value 6: {{ macro.DP_Site_CVal06 }}
- Dial Plan Custom Value 7: {{ macro.DP_Site_CVal07 }}
- Dial Plan Custom Value 8: {{ macro.DP_Site_CVal08 }}
- Dial Plan Custom Value 9: {{ macro.DP_Site_CVal09 }}
- Dial Plan Custom Value 10: {{ macro.DP_Site_CVal10 }}

15.5.8. Diagram Example

The diagram below provides an example of the use of a macro in a Global (customer) level dial plan element: **Route Patterns**.

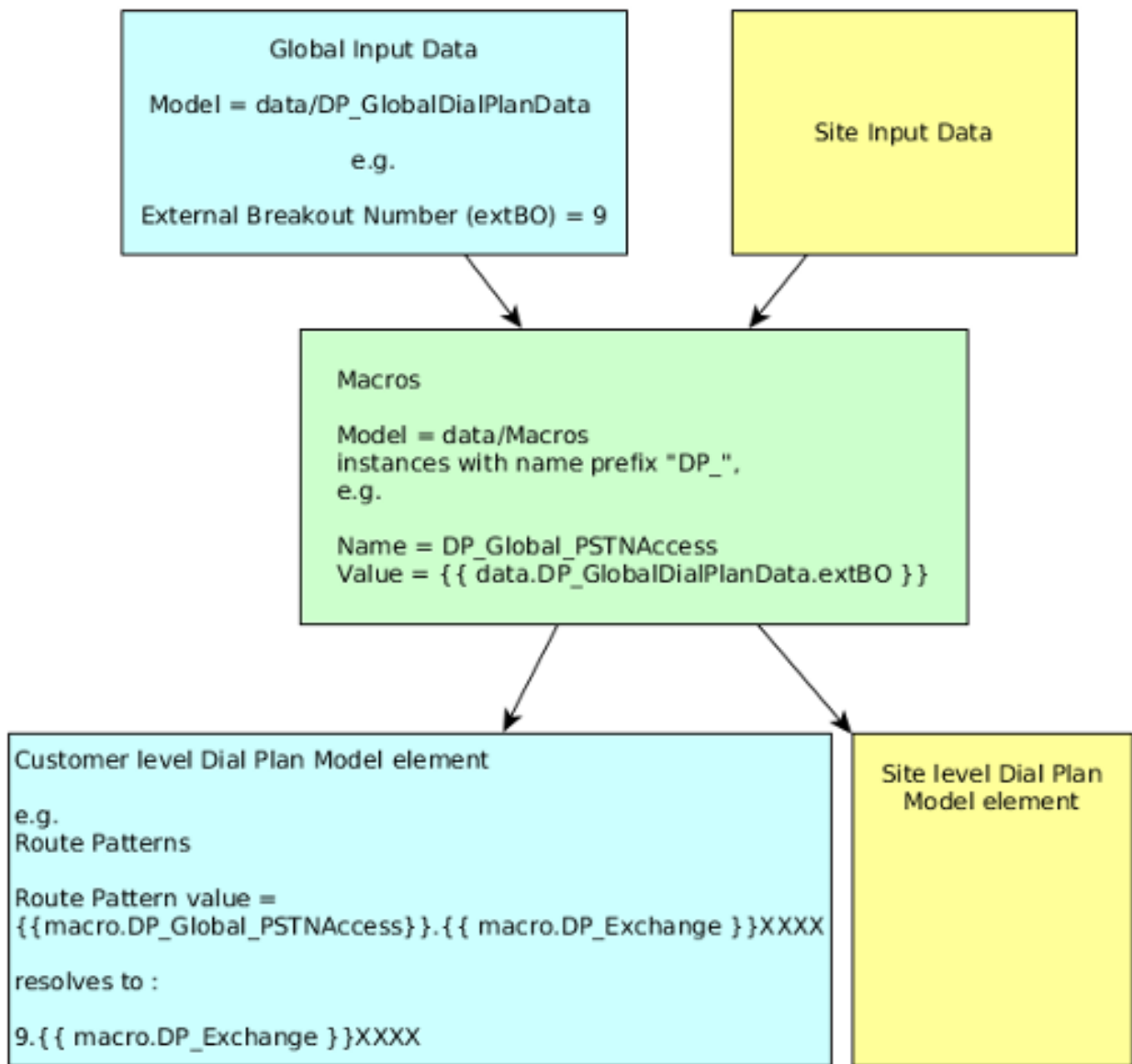

15.6. Dial Plan Models

Dial plan models (default menu: **Dial Plan Management > Dial Plan Model**) allow you to define the dial plan and to enter a name and type to group its elements.

The Dial Plan Type drop-down is used to tag it with its hierarchy, so that available dial plans to push or remove are filtered when using the Dial Plan Maintenance menu:

- Multi-tenant / Shared Architecture - provider hierarchy
- Global - customer hierarchy
- Site - site hierarchy

Note: If no Dial Plan Type tag is added to a dial plan, a new “in-progress” or “staging” dial plan can be created that will not show up to be pushed or removed on the Dial Plan Maintenance menu.

A description and notes for the Dial Plan Model definition can be added on the input form.

15.6.1. Dial Plan Model Elements

The remaining list of menus manage elements of dial plans created with the feature. Individual elements such as Route Patterns, SIP Trunks, and Translation Patterns each have a menu item from which it can be associated with a Dial Plan Model and managed.

The feature provides menu items or input fields to extend schema based dial plan management functionality. When a dial plan created with the feature is pushed from the **Dial Plan Maintenance** menu, the transaction log can be inspected to see the extended functionality:

- Device Pools - Regions - Locations -SRST
- Transcoders
- Conference Bridge
- Media Resource Groups
- Media Resource Group Lists
- Route Groups
- SIP Trunks
- CTI Route Points *with Lines* (Lines are not supported in schemas)

When managing these dial plan elements, the installed named macros can be used to refer to data added from the **Dial Plan Input Data** menu.

Route Patterns [Tiered_Cust_Level_DP]

Dial Plan Name*	Tiered_Cust_Level_DP
Local Dialing	<input checked="" type="checkbox"/>
Route Pattern	{{ macro.DP_Global_PSTNAccess }}-{{ macro.DP_AreaCode }}XXXXXX
Route Pattern Description	10 digit Digit Local
Route Partition	{{ macro.DP_CustomerName }}-LD-PT

The list view from each of these menus shows the Dial Plan Name - as defined from the **Dial Plan Model** menu - to which the element belongs. The feature structures the elements as instances of distinct data models.

There is an additional flexibility in the **Route Patterns** and **Translation Patterns** dial plan model elements so that a **Local Dialing** check box can be selected here if required when using a simpler or flat dial plan.

Dial Plan elements, such as Calling Search Space, can be cloned and edited to easily add another element to the dial plan by defining an “add-on” dial plan model, associating the cloned CSS element with it and pushing it to the required Call Manager cluster using the **Dial Plan Maintenance** menu. In this way the dial plan can be then be updated - functionality that is not possible in a schema based approach.

Additional workflows in the feature allow for values (for example MRGL) to be added from for example the **Device Pools - Regions - Locations -SRST** element input form, since the workflow will push to the these to the Call Manager cluster *only after* the prerequisite values become available. Inspect the transaction log to see the required sequence of data carried out with these workflows.

15.6.2. Device Pools - Regions - Locations - SRST

The Device Pool, Region, Location and SRST Reference dial plan model have been combined into one coherent data model for ease of entry into a call manager since the elements are often related.

Dp Dp-Reg-Loc [Site_Level_DP] Save Delete Help Back Action ▾

Device Pool Region Location SRST Reference

Dial Plan Name	Site_Level_DP
Device Pool Name*	{{ macro.SITENAME }}-DP
Call Manager Group	Default
Region	{{ macro.SITENAME }}-REG
Location	{{ macro.SITENAME }}-LOC
SRST Reference*	{{ macro.SITENAME }}-SRST
Date/Time Group	CMLocal

- **Device Pool** tab fields:

- **Dial Plan Name:** Drop-down driven unique name given to the entire dial plan as a whole. This name appears in every dial plan model type.
- **Device Pool Name:** Free text field to add a device pool name or macro. In this example the name is built using a macro reference and a static extension of `-DP`.
- **Call Manager Group:** Free text field to add a call manager group name.
- **Region:** Free text field to enter a call manager existing region to the device pool or the field will automatically update with the name of the custom added region from the **Region** tab.
- **Location:** Free text field to enter a call manager existing location to the device pool or the field will automatically update with the name of the custom added location from the **Location** tab.
- **SRST Reference:** Free text field to enter a call manager existing SRST reference to the device pool or the field will automatically update with the name of the custom added SRST reference from the **SRST Reference** tab.
- **Date/Time Group:** Free text field to add a date time group name.

Dp Dp-Reg-Loc [Site_Level_DP] Save Delete Help Back Action ▾

Device Pool | **Region** | **Location** | **SRST Reference**

Add Custom Region

Region Name*

Related Region +

- +

Related Region Name

Codec Preference

Audio Bandwidth

Video Bandwidth

Immersive Video Bandwidth

Lossy Network

- **Region** tab fields:
 - **Add Custom Region:** Check box to optionally add a custom region.
 - **Region Name:** Free text field to add a region name. In this example the name is built using a macro reference and a static extension of `-REG`.
 - **Related Region:** Ability to add related regions to the custom region.
 - * **Related Region Name:** Free text field to add a related region.
 - * **Codec Preference:** Drop-down with choices:
 - Use System Default
 - Factory Default lossy
 - Factory Default low loss
 - * **Audio Bandwidth:** Drop-down with choices:
 - Use System Default
 - 7 kbps (GSM-HR, G.723.1)
 - 8 kbps (G.729)
 - 13 kbps (GSM-FR, AMR)
 - 16 kbps (iLBC, G.728)
 - 24 kbps (AMR-WB)
 - 32 kbps (iSAC, G.722.1)
 - 64 kbps (G.711)
 - 128 kbps (AAC-LD [LATM])
 - 256 kbps (L16, AAC-LD)
 - * **Video Bandwidth:** Drop-down to choose video bandwidth setting with choices:
 - Use System Default
 - Not Allowed
 - * **Immersive Video Bandwidth:** Drop-down to choose immersive video bandwidth with choices:
 - Use System Default
 - Not Allowed
 - * **Lossy Network:** Drop-down to choose lossy network setting with choices:
 - Use System Default
 - Keep Current Setting
 - Low Loss
 - Lossy

Dp Dp-Reg-Loc [Site_Level_DP] Save Delete Help Back Action ▾

Device Pool **Region** **Location** **SRST Reference**

Add Custom Location

Location Name*

Within Audio Bandwidth

Within Video Bandwidth

Within Immersive Kbits

Between Location +

- +

Location Name

Audio Bandwidth

Video Bandwidth (kbps)

Immersive Bandwidth

Weight

- **Location** tab fields:
 - **Add Location:** Check box to optionally add a custom Location.
 - **Location Name:** Free text field to add a location name. In this example the name is built using a macro reference and a static extension of `-LOC`.
 - **Within Audio Bandwidth**
 - **Within Video Bandwidth**
 - **Within Immersive Kbits**
 - **Between Location** group of fields:
 - * **Location Name**
 - * **Audio Bandwidth**
 - * **Video Bandwidth**
 - * **Immersive Bandwidth**
 - * **Weight**

Dp Dp-Reg-Loc [Site_Level_DP] Save Delete Help Back Action ▾

Device Pool **Region** **Location** **SRST Reference**

Add Custom SRST Reference

Name*

Port

IP Address*

SIP Network/IP Address

SIP Port

Is SRST Secure?

- **SRST Reference** tab fields:
 - **Add SRST Reference:** Check box to optionally add a custom SRST Reference.
 - **SRST Reference Name:** Free text field to add a SRST Reference name. In this example the name is built using a macro reference and a static extension of –SRST.
 - **Port**
 - **IP Address**
 - **SIP Network/IP Address**
 - **SIP Port**
 - **SRST Secure?**

15.6.3. Time Period Model

This allows the administrator to define an unlimited number of time periods.

Dp Time Period					Add	Delete	Help	Action ▾
<input type="checkbox"/>	Dial Plan Name	Time Period Name	Description	Hierarchy				
<input type="checkbox"/>	Site_Level_DP	AllTheTime	AllTheTime	sys.hcs.VLS				
<input type="checkbox"/>	Site_Level_DP	BusinessHours	BusinessHours	sys.hcs.VLS				
<input type="checkbox"/>	Site_Level_DP	MonthEnd	MonthEnd	sys.hcs.VLS				
<input type="checkbox"/>	Tiered_Cust_Level_DP	MonthEnd	MonthEnd	sys.hcs				
<input type="checkbox"/>	Tiered_Cust_Level_DP	BusinessHours	BusinessHours	sys.hcs				
<input type="checkbox"/>	Tiered_Cust_Level_DP	AllTheTime	AllTheTime	sys.hcs				

Dp Time Period [Site_Level_DP]		Save	Delete	Help	Back	Action ▾
Dial Plan Name*	<input type="text" value="Site_Level_DP"/>					
Time Period Name*	<input type="text" value="BusinessHours"/>					
Description	<input type="text" value="BusinessHours"/>					
Time of Day Start*	<input type="text" value="07:00"/>					
Time of Day End*	<input type="text" value="17:00"/>					
Start Day	<input type="text" value="Mon"/>					
End Day	<input type="text" value="Fri"/>					
Start Month	<input type="text" value="None"/>					
Start Day of Month	<input type="text" value="0"/>					
End Month	<input type="text" value="None"/>					
End Day of Month	<input type="text" value="0"/>					

Time Period fields:

- **Dial Plan Name:** Drop-down driven unique name given to the entire dial plan as a whole. This name appears in every dial plan model type.
- **Time Period Name:** The free text name for desired time period.
- **Description:** Meaningful description of the time period.
- **Time of Day Start:** Drop-down driven field to set start of time period in 15 minute increments.
- **Time of Day End:** Drop-down driven field to set end of time period in 15 minute increments.
- **Start Day:** Drop-down driven field to set start day giving “Mon”-“Fri” and “None” as options.
- **End Day:** Drop-down driven field to set end day giving “Mon”-“Fri” and “None” as options.
- **Start Month:** Drop-down driven field to set start month giving “Jan”-“Dec” and “None” as options.

- **Start Month:** Drop-down driven field to set start month giving “Jan”-“Dec” and “None” as options.
- **Start Day of Month:** Free text field to add integer of start day of the month
- **End Month:** Drop-down driven field to set end month giving “Jan”-“Dec” and “None” as options.
- **End Day of Month:** Free text field to add integer of start day of the month.

15.6.4. Time Schedule Model

This allows the administrator to define an unlimited number of time schedules.

Dp Time Schedule					Add	Delete	Help	Action ▾
<input type="checkbox"/>	Dial Plan Name	Time Schedule Name	Description	Hierarchy				
<input type="checkbox"/>	Site_Level_DP	WorkHours	Work Hours	sys.hcs.VLS				
<input type="checkbox"/>	Site_Level_DP	AllPeriods	All Periods	sys.hcs.VLS				
<input type="checkbox"/>	Site_Level_DP	AfterHours	Work Hours	sys.hcs.VLS				
<input type="checkbox"/>	Site_Level_DP	BeforeHours	Work Hours	sys.hcs.VLS				
<input type="checkbox"/>	Tiered_Cust_Level_DP	AllPeriods	All Periods	sys.hcs				
<input type="checkbox"/>	Tiered_Cust_Level_DP	WorkHours	Work Hours	sys.hcs				
<input type="checkbox"/>	Tiered_Cust_Level_DP	AfterHours	Work Hours	sys.hcs				
<input type="checkbox"/>	Tiered_Cust_Level_DP	BeforeHours	Work Hours	sys.hcs				

Dp Time Schedule [Site_Level_DP]		Save	Delete	Help	Back	Action ▾
Dial Plan Name	<input type="text" value="Site_Level_DP"/>					
Time Schedule Name*	<input type="text" value="WorkHours"/>					
Description	<input type="text" value="Work Hours"/>					
Time Periods	<div style="border: 1px solid #ccc; padding: 5px;"> <div style="border-bottom: 1px solid #ccc; padding: 5px;"> <div style="display: flex; justify-content: space-between; align-items: center;"> + - + ▼ </div> <div style="margin-top: 5px;"> <p>Time Period Name <input type="text" value="BusinessHours"/></p> </div> </div> <div style="border-bottom: 1px solid #ccc; padding: 5px;"> <div style="display: flex; justify-content: space-between; align-items: center;"> - + ▲ </div> <div style="margin-top: 5px;"> <p>Time Period Name <input type="text" value="MonthEnd"/></p> </div> </div> </div>					

Time Schedule fields:

- **Dial Plan Name:** Drop-down driven unique name given to the entire dial plan as a whole. This name appears in every dial plan model type.
- **Time Schedule Name:** Free text field to enter a unique time schedule name.
- **Description:** Meaningful description of the time schedule.
- **Time Periods:** An array of time periods that provides drop-downs of time periods defined from the Time Period.

15.6.5. Transcoder Model

The transcoder dial plan model allows the administrator to define an unlimited number of transcoders.

Dp Transcoder				Add	Delete	Help	Action ▾
■	Dial Plan Name ^	Conference Bridge Name	Hierarchy				
□	Site_Level_DP	{{ fn.sub_string macro.SITENAME, 3,4 }}_XCODE_R1	sys.hcs				
□	Tiered_Cust_Level_DP	{{ macro.DP_CustomerName }}_XCODE	sys.hcs				

Dp Transcoder [Tiered_Cust_Level_DP]		Save	Delete	Help	Back	Action ▾
Dial Plan Name	Tiered_Cust_Level_DP ▾					
Transcoder Type	Cisco IOS Media Termination Point ▾					
Transcoder Name	{{ macro.DP_CustomerName }}_XCODE					
Description	{{ macro.DP_CustomerName }} Transcoder					
Device Pool	{{ macro.DP_CustomerName }}-DP					
Use Trusted Relay Point	Default ▾					

Transcoder fields:

- **Dial Plan Name:** Drop-down driven unique name given to the entire dial plan as a whole. This name appears in every dial plan model type
- **Transcoder Type:** Drop-down field to set Transcoder Type. Currently only supports Cisco IOS Media Termination Point but will be expanded based on market input.
- **Transcoder Name:** Free Text field where a unique name should be entered. In the above example the macro will fill the VOSS customer name with `_XCODE` suffix.
- **Description:** Meaningful description of the transcoder
- **Device Pool:** Free text field to identify the proper device pool.
- **Use Trusted Relay Point:** Drop-down with values:
 - Default
 - Off
 - On

15.6.6. Conference Bridge Model

The Conference Bridge dial plan model allows the administrator to define an unlimited number of Conference Bridges.

Dp Conf Bridge			Add	Delete	Help	Action ▼
■	Dial Plan Name	▲ Conference Bridge Name	Hierarchy			
<input type="checkbox"/>	Site_Level_DP	{{ fn.sub_string macro.SITENAME, 3,4 }}_CFB_R1	sys.hcs			
<input type="checkbox"/>	Tiered_Cust_Level_DP	{{ macro.DP_CustomerName }}_CFB	sys.hcs			

Dp Conf Bridge [Tiered_Cust_Level_DP]		Save	Delete	Help	Back	Action ▼
Dial Plan Name	Tiered_Cust_Level_DP					
Conference Bridge Type	Cisco IOS Conference Bridge					
Conference Bridge Name	{{ macro.DP_CustomerName }}_CFB					
Description	{{ macro.DP_CustomerName }} Conf Bridge					
Device Pool	{{ macro.DP_CustomerName }}-DP					
Location	{{ macro.DP_CustomerName }}-LOC					
Use Trusted Relay Point	Default					

Conference Bridge fields:

- **Dial Plan Name:** Drop-down driven unique name given to the entire dial plan as a whole. This name appears in every dial plan model type.
- **Conference Bridge Type:** Drop-down field to set Transcoder Type. Currently only supports Cisco IOS Conference Bridge but will be expanded based on market input.
- **Conference Bridge Name:** Free Text field where a unique name should be entered. In the above example the macro will fill the VOSS customer name with `_CFB` suffix.
- **Description:** Meaningful description of the Conference Bridge.
- **Device Pool:** Free text field to identify the proper Device Pool.
- **Location:** Free text field to identify the proper Location.
- **Use Trusted Relay Point:** Drop-down with values:
 - Default
 - Off
 - On

15.6.7. Media Resource Group Model

The Media Resource Group dial plan model allows the administrator to define an unlimited number of Media Resource Groups.

Dp Media Resource Group			Add	Delete	Help	Action ▾
Dial Plan Name	Media Resource Group Name	Hierarchy				
Site_Level_DP	{{ macro.SITENAME }}-MRG	sys.hcs				
Tiered_Cust_Level_DP	{{ macro.DP_CustomerName }}-MRG	sys.hcs				

Dp Media Resource Group [Tiered_Cust_Level_DP]		Save	Delete	Help	Back	Action ▾
Dial Plan Name	Tiered_Cust_Level_DP					
Media Resource Group Name	{{ macro.DP_CustomerName }}-MRG					
Description	{{ macro.DP_CustomerName }} Media Resource Group					
Devices for this Group	<div style="border: 1px solid #ccc; padding: 5px;"> <div style="border-bottom: 1px solid #ccc; padding: 2px 5px;"> - + </div> <div style="padding: 2px 5px;"> Media Resource: {{ macro.DP_CustomerName }}_CFB </div> <div style="border-bottom: 1px solid #ccc; padding: 2px 5px;"> - + </div> <div style="padding: 2px 5px;"> Media Resource: {{ macro.DP_CustomerName }}_XCODE </div> </div>					

Media Resource Group fields:

- **Dial Plan Name:** Drop-down driven unique name given to the entire dial plan as a whole. This name appears in every dial plan model type.
- **Media Resource Group Name:** Free text field to enter a unique name for the Media Resource Group.
- **Description:** Meaningful description of the Media Resource Group.
- **Devices for this Group:** Array of member media resources for the Media Resource Group. In this instance using macros to enter the two customer level Transcoder and Conference Bridge instances.

15.6.8. Media Resource Group List Model

The Media Resource Group List dial plan model allows the administrator to define an unlimited number of Media Resource Group Lists.

Dp Media Resource Group List			Add	Delete	Help	Action ▾
Dial Plan Name	Media Resource Group List Name	Hierarchy				
Site_Level_DP	{{ macro.SITENAME }}-MRGL	sys.hcs				
Tiered_Cust_Level_DP	{{ macro.DP_CustomerName }}-MRGL	sys.hcs				

Dp Media Resource Group List [Tiered_Cust_Level_DP]		Save	Delete	Help	Back	Action ▾
Dial Plan Name	Tiered_Cust_Level_DP					
Media Resource Group List Name	{{ macro.DP_CustomerName }}-MRGL					
Media Resource Groups	<div style="border: 1px solid #ccc; padding: 5px;"> <div style="border: 1px solid #ccc; padding: 5px;"> <div style="border: 1px solid #ccc; padding: 5px;"> Media Resource Group: {{ macro.DP_CustomerName }}-MRG </div> </div> </div>					

Media Resource Group List fields:

- **Dial Plan Name:** Drop-down driven unique name given to the entire dial plan as a whole. This name appears in every dial plan model type.
- **Media Resource Group List Name:** Free text field to enter a unique name for the Media Resource Group List
- **Media Resource Groups:** Array of media resource groups to assign to the Media Resource Group List. In this example binding the customer level MRG.

15.6.9. Route List Model

The Route List dial plan model allows the administrator to define an unlimited number of Route Lists.

Dp Route List				Add	Delete	Help	Action ▾
<input type="checkbox"/>	Dial Plan Name	Route List Name	Hierarchy				
<input type="checkbox"/>	Site_Level_DP	{{ macro.SITENAME }}-AGGR-RL	sys.hcs.VLS				
<input type="checkbox"/>	Site_Level_DP	{{ macro.SITENAME }}-UNITY-RL	sys.hcs.VLS				
<input type="checkbox"/>	Tiered_Cust_Level_DP	{{ macro.DP_CustomerName }}-UNITY-RL	sys.hcs				
<input type="checkbox"/>	Tiered_Cust_Level_DP	{{ macro.DP_CustomerName }}-AGGR-RL	sys.hcs				

Dp Route List [Site_Level_DP] Save Delete Help Back Action ▾

Dial Plan Name: Site_Level_DP ▾

Route List Name: {{ macro.SITENAME }}-AGGR-RL

Route List Description: {{ macro.SITENAME }} AGGR Route List

Call Manager Group Name: Default

Route List Enabled:

Members

Route Group Name:

Selection Order:

Use Calling Party's External Phone Number:

Party's External Phone Number Mask: ▾

Calling Party Transform Mask:

Calling Party Prefix Digits (Outgoing Calls):

Called Party Discard Digits: ▾

Called Party Transform Mask:

Called Party Prefix Digits (Outgoing Calls):

Run On Every Node:

Route List fields:

- **Dial Plan Name:** Drop-down driven unique name given to the entire dial plan as a whole. This name appears in every dial plan model type.
- **Route List Name:** Free text field to enter a unique name for the Route List
- **Route List Description:** Meaningful description of the Route List.
- **Call Manager Group Name:** Free text field to designate the proper Call Manager Group
- **Route list Enabled:** Check box to set the Route List Enabled field in Call Manager.
- **Members:** Array to enter member elements to the route list.
 - **Route Groups Name:** Free text field to assign a route group to the Route List.
 - **Selection Order:** The order in which the Route Groups will be placed in the Route List.
 - Use Calling Party's External Phone Number Mask: Drop-down providing Call Manager available options:
 - * Default
 - * On
 - * Off
 - **Calling Party Transform Mask:** Free text field to enter common Call Manager Transform Mask data.
 - **Calling Party Prefix Digits (Outgoing Calls):** Free text field to enter common Call Manager Calling Party Prefix Digit data.
 - **Called Party Discard Digits:** Drop-down providing Call Manager available options:
 - * None
 - * PreDot
 - * PreDot Trailing-#

Note that more discard instructions may be added at market demand.

- **Called Party Transform Mask:** Free text field to enter common Call Manager Transform Mask data.
- **Called Party Prefix Digits (Outgoing Calls):** Free text field to enter common Call Manager Called Party Prefix Digit data

15.6.10. Route Group Model

The Route Group dial plan model allows the administrator to define an unlimited number of Route Groups.

Dp Route Group			Add	Delete	Help	Action ▾
■	Dial Plan Name	Route Group Name	Hierarchy			
□	Site_Level_DP	{{ macro.SITENAME }}-LRG	sys			
□	Tiered_Cust_Level_DP	{{ macro.DP_CustomerName }}-RG	sys			

Dp Route Group [Tiered_Cust_Level_DP]		Save	Delete	Help	Back	Action ▾
Dial Plan Name	Tiered_Cust_Level_DP					
Route Group Name	{{ macro.DP_CustomerName }}-RG					
Distribution Algorithm	Circular					
Route Group Devices	<div style="border: 1px solid #ccc; padding: 5px;"> <div style="border-bottom: 1px solid #ccc; padding: 2px 5px;"> - + ▾ </div> <div style="padding: 2px 5px;"> Device <input type="text" value="{{ macro.CustomerName }}-AGGR-SIPTRK-P"/> </div> </div> <div style="border-bottom: 1px solid #ccc; padding: 2px 5px; margin-top: 5px;"> - + ▴ </div> <div style="padding: 2px 5px;"> Device <input type="text" value="{{ macro.CustomerName }}-AGGR-SIPTRK-S"/> </div>					

Route Group fields:

- **Dial Plan Name:** Drop-down driven unique name given to the entire dial plan as a whole. This name appears in every dial plan model type.
- **Route Group Name:** Free text field to enter a unique name for the Route Group
- **Distribution Algorithm:** Drop-down providing the Call Manager options:
 - Top Down
 - Circular
 - Longest Idle Time
 - Broadcast
- **Route Group Devices:** Array to add devices to the route group. In this example a primary and secondary SIP trunk to aggregation.

15.6.11. SIP Trunk Model

The SIP Trunk dial plan model allows the administrator to define an unlimited number of SIP Trunks.

Dp Sip Trunk				Add	Delete	Help	Action ▾
■	Dial Plan Name	↑	SIP Trunk Name	Hierarchy			
<input type="checkbox"/>	Site_Level_DP		{{ macro.SITENAME }}-SipTrunk	sys			
<input type="checkbox"/>	Tiered_Cust_Level_DP		{{ macro.DP_CustomerName }}-SipTrunk	sys.hcs			

Dp Sip Trunk [Tiered_Cust_Level_DP]						Save	Delete	Help	Back	Action ▾
Dial Plan Name	Tiered_Cust_Level_DP ▾									
SIP Trunk Name	{{ macro.DP_CustomerName }}-SipTrunk									
Description	{{ macro.DP_CustomerName }} SIP Trunk									
Device Pool	{{ macro.DP_CustomerName }}-DP									
Call Classification	OffNet ▾									
Media Resource Group List	{{ macro.DP_CustomerName }}-MRGL									
Location	{{ macro.DP_CustomerName }}-LOC									
Run On All Active Unified CM Nodes	<input checked="" type="checkbox"/>									
Inbound Call CSS	{{ macro.DP_CustomerName }}-PSTNInbound-CSS									
SIP Information	<div style="border: 1px solid #ccc; padding: 5px;"> <div style="border-bottom: 1px solid #ccc; padding-bottom: 5px;"> <input type="checkbox"/> Destination Address is an SRV </div> <div style="padding: 5px;"> Destination Address: <input type="text" value="1.2.3.4"/> </div> <div style="padding: 5px;"> Destination Address IPv6: <input type="text"/> </div> <div style="padding: 5px;"> Destination Port: <input type="text" value="5060"/> </div> </div>									
SIP Trunk Security Profile	Non Secure SIP Trunk Profile									
SIP Profile	Standard SIP Profile									

SIP Trunk fields:

- **Dial Plan Name:** Drop-down driven unique name given to the entire dial plan as a whole. This name appears in every dial plan model type.

- **SIP Trunk Name:** Defines a unique name for the SIP Trunk
- **Description:** Defines a meaningful description of the SIP Trunk.
- **Device Pool:** Free text field to enter the proper device pool for the trunk
- **Call Classification:** A drop-down to select a call manager. Options are:
 - Offnet
 - OnNet
 - Use System Default
- **Media Resource Group List:** Defines the proper MRGL for the SIP Trunk.
- **Location:** Defines the location for the SIP Trunk.
- **Run On All Active CM Nodes:** Defines whether to set the run on all nodes.
- **Inbound Call CSS:** Defines the proper CSS for SIP Trunks per dial plan.
- **Inbound Prefix DN:** Defines the prefix digits to append to the called party number on incoming calls. CUCM adds prefix digits after first truncating the number (based on the Significant Digits setting). You can use the exit code +
- **Incoming Number Prefix:** Typically used for outbound click-to-dial from a handset call history.
- **SIP Information:** Array to add multiple SIP IP Destination:
 - **Destination Address:** The IPv4 IP address of the destination.
 - **Destination Address IPv6:** The IPv6 of the destination.
 - **Destination Port:** The TCP/IP port for the SIP Trunk instance.
- **SIP Trunk Security Profile:** Defines the SIP Trunk Security Profile.
- **SIP Profile:** Defines the SIP Profile.

15.6.12. Partition Model

The Partition dial plan model allows the administrator to define an unlimited number of Partitions.

Dp Partition				Add	Delete	Help	Action ▾
<input type="checkbox"/>	Dial Plan Name	Partition Name	Hierarchy				
<input type="checkbox"/>	Site_Level_DP	{{ macro.SITENAME }}-PSTNInbound-PT	sys.hcs.VLS				
<input type="checkbox"/>	Site_Level_DP	{{ macro.SITENAME }}-Unity-PT	sys.hcs.VLS				
<input type="checkbox"/>	Site_Level_DP	{{ macro.SITENAME }}-INTL-PT	sys.hcs.VLS				
<input type="checkbox"/>	Site_Level_DP	{{ macro.SITENAME }}-LD-PT	sys.hcs.VLS				
<input type="checkbox"/>	Site_Level_DP	{{ macro.SITENAME }}-LOCAL-PT	sys.hcs.VLS				
<input type="checkbox"/>	Site_Level_DP	{{ macro.SITENAME }}-INTERNAL-PT	sys.hcs.VLS				
<input type="checkbox"/>	Tiered_Cust_Level_DP	{{ macro.DP_CustomerName }}-INTERNAL-PT	sys.hcs				
<input type="checkbox"/>	Tiered_Cust_Level_DP	{{ macro.DP_CustomerName }}-PSTNInbound-PT	sys.hcs				
<input type="checkbox"/>	Tiered_Cust_Level_DP	{{ macro.DP_CustomerName }}-LD-PT	sys.hcs				
<input type="checkbox"/>	Tiered_Cust_Level_DP	{{ macro.DP_CustomerName }}-Unity-PT	sys.hcs				
<input type="checkbox"/>	Tiered_Cust_Level_DP	{{ macro.DP_CustomerName }}-INTL-PT	sys.hcs				
<input type="checkbox"/>	Tiered_Cust_Level_DP	{{ macro.DP_CustomerName }}-LOCAL-PT	sys.hcs				

Dp Partition [Site_Level_DP]		Save	Delete	Help	Back	Action ▾
Dial Plan Name	<input type="text" value="Site_Level_DP"/>					
Partition Name	<input type="text" value="{{ macro.SITENAME }}-PSTNInbound-PT"/>					
Partition Description	<input type="text" value="{{ macro.SITENAME }} PSTN Inbound"/>					
Partition Time Schedule	<input type="text" value="All the time"/>					

Partition fields:

- **Dial Plan Name:** Drop-down driven unique name given to the entire dial plan as a whole. This name appears in every dial plan model type.
- **Partition Name:** Free text field to enter a unique name for the Partition.
- **Partition Description:** Meaningful description of the Partition.
- **Partition Time Schedule:** Time schedule for the Partition if required per dial plan. May be left blank.

15.6.13. Calling Search Space Model

The Calling Search Space (CSS) dial plan model allows the administrator to define an unlimited number of CSS.

Dp Css			Add	Delete	Help	Action ▼
<input type="checkbox"/>	Dial Plan Name	^ CSS Name	Hierarchy			
<input type="checkbox"/>	Site_Level_DP	{{ macro.SITENAME }}-PSTNInbound-CSS	sys.hcs.VLS			
<input type="checkbox"/>	Site_Level_DP	{{ macro.SITENAME }}-LD-CSS	sys.hcs.VLS			
<input type="checkbox"/>	Site_Level_DP	{{ macro.SITENAME }}-LOCAL-CSS	sys.hcs.VLS			
<input type="checkbox"/>	Site_Level_DP	{{ macro.SITENAME }}-INTERNAL-CSS	sys.hcs.VLS			
<input type="checkbox"/>	Site_Level_DP	{{ macro.SITENAME }}-INTL-CSS	sys.hcs.VLS			
<input type="checkbox"/>	Tiered_Cust_Level_DP	{{ macro.DP_CustomerName }}-PSTNInbound-CSS	sys.hcs			
<input type="checkbox"/>	Tiered_Cust_Level_DP	{{ macro.DP_CustomerName }}-INTL-CSS	sys.hcs			
<input type="checkbox"/>	Tiered_Cust_Level_DP	{{ macro.DP_CustomerName }}-LD-CSS	sys.hcs			
<input type="checkbox"/>	Tiered_Cust_Level_DP	{{ macro.DP_CustomerName }}-INTERNAL-CSS	sys.hcs			
<input type="checkbox"/>	Tiered_Cust_Level_DP	{{ macro.DP_CustomerName }}-LOCAL-CSS	sys.hcs			
<input type="checkbox"/>	Tiered_Site_Level_DP	{{ macro.SITENAME }}-LD-CSS	sys.hcs			
<input type="checkbox"/>	Tiered_Site_Level_DP	{{ macro.SITENAME }}-INTL-CSS	sys.hcs			
<input type="checkbox"/>	Tiered_Site_Level_DP	{{ macro.SITENAME }}-INTERNAL-CSS	sys.hcs			
<input type="checkbox"/>	Tiered_Site_Level_DP	{{ macro.SITENAME }}-LOCAL-CSS	sys.hcs			

Dp Css [Tiered_Cust_Level_DP] Save Delete Help Back Action ▾

Dial Plan Name

CSS Name

CSS Description

Partitions

+

- + ▾

Route Partition *
Names

Partition Index

- + ▴ ▾

Route Partition *
Names

Partition Index

- + ▴ ▾

Route Partition *
Names

Partition Index

- + ▴ ▾

Route Partition *
Names

Partition Index

- + ▴

Route Partition *
Names

Partition Index

CSS fields:

- **Dial Plan Name:** Drop-down driven unique name given to the entire dial plan as a whole. This name appears in every dial plan model type.
- **CSS Name:** Free text field to enter a unique name for the CSS.
- **CSS Description:** Meaningful description of the CSS.

- **Partitions:** Array to add Partitions associated in order to the CSS.
 - **Route Partition Name:** Free text field to enter valid Partition name
 - **Partition Index:** Free text field to enter the numeric id for Partition order.

15.6.14. Route Pattern Model

The Route Pattern dial plan model allows the administrator to define an unlimited number of Route Patterns. “Local Dialing” flag will be covered in a following section.

Dp Route Pattern				Add	Delete	Help	Action ▾
<input type="checkbox"/>	Dial Plan Name	Local Dialing	Route Pattern	Route Filter	Hierarchy		
<input type="checkbox"/>	Site_Level_DP		9.911		sys.hcs.VLS		
<input type="checkbox"/>	Site_Level_DP		9.1[2-9]XX[2-9]XXXX		sys.hcs.VLS		
<input type="checkbox"/>	Site_Level_DP		9.0111		sys.hcs.VLS		
<input type="checkbox"/>	Site_Level_DP	true	{{ macro.DP_extBO }},{{ macro.DP_Exchange }}XXX		sys.hcs.VLS		
<input type="checkbox"/>	Site_Level_DP	true	{{ macro.DP_extBO }},{{ input.areacode.areaCode}}		sys.hcs.VLS		
<input type="checkbox"/>	Site_Level_DP		911		sys.hcs.VLS		
<input type="checkbox"/>	Site_Level_DP		8000		sys.hcs.VLS		
<input type="checkbox"/>	Site_Level_DP		9.[2-9]XX[2-9]XXXX		sys.hcs.VLS		
<input type="checkbox"/>	Tiered_Cust_Level_DP		9.0111		sys.hcs		
<input type="checkbox"/>	Tiered_Cust_Level_DP		911		sys.hcs		
<input type="checkbox"/>	Tiered_Cust_Level_DP		9.1[2-9]XX[2-9]XXXX		sys.hcs		
<input type="checkbox"/>	Tiered_Cust_Level_DP		8000		sys.hcs		
<input type="checkbox"/>	Tiered_Cust_Level_DP		9.[2-9]XX[2-9]XXXX		sys.hcs		
<input type="checkbox"/>	Tiered_Cust_Level_DP		9.911		sys.hcs		
<input type="checkbox"/>	Tiered_Site_Level_DP	true	{{ macro.DP_extBO }},{{ macro.DP_Exchange }}XXX		sys.hcs		
<input type="checkbox"/>	Tiered_Site_Level_DP	true	{{ macro.DP_extBO }},{{ input.areacode.areaCode}}		sys.hcs		

Dp Route Pattern [Tiered_Cust_Level_DP] Save Delete Help Back Action ▾

Dial Plan Name	Tiered_Cust_Level_DP ▾
Local Dialing	<input type="checkbox"/>
Route Pattern	9.1[2-9]XX[2-9]XXXX
Route Pattern Description	{{ macro.DP_CustomerName }} Long Distance Dialing
Route Partition	{{ macro.DP_CustomerName }}-LD-PT
Numbering Plan	
Route Filter	
Route List	{{ macro.DP_CustomerName }}-AGGR-RL
Gateway Name	
Route Option	Route this pattern ▾
Release Clause	No Error ▾
Call Classification	OffNet ▾
Allow Device Override	<input type="checkbox"/>
Provide Outside Dial Tone	<input checked="" type="checkbox"/>
Allow Overlap Sending	<input type="checkbox"/>
Urgent Priority	<input type="checkbox"/>
Authorization Level	0
Require Forced Authorization Code	<input type="checkbox"/>
Require Client Matter Code	<input type="checkbox"/>
Use Calling Party's External Phone Number Mask	Default
Calling Party Transform Mask	
Calling Party Prefix Digits (Outgoing Calls)	
Called Party Discard Digits	PreDot ▾
Called Party Transform Mask	
Called Party Prefix Digits (Outgoing Calls)	
Calling Line Presentation Bit	
Calling Name Presentation Bit	
Connected Line Presentation Bit	
Connected Name Presentation Bit	
MLPP Precedence	Default ▾

Route Pattern fields:

- **Dial Plan Name:** Drop-down driven unique name given to the entire dial plan as a whole. This name appears in every dial plan model type.
- **Local Dialing:** Check box to identify special patterns.
- **Route Pattern:** Free text field to enter a common Call Manager routing pattern.
- **Route Pattern Description:** Meaningful description of the Route Pattern.
- **Route Partition:** Free text field to enter a valid CUCM Partition.
- **Numbering Plan:** Free text field to enter a valid CUCM Numbering Plan if IDP is utilized.
- **Route Filter:** Free text field to enter a valid route filter name.
- **Route List:** Free text field to enter a valid route list name.
- **Gateway Name:** Free text field to enter a valid gateway name.
- **Route Option:** Drop-down providing Call Manager option:

- Route this pattern
- Block this pattern
- **Release Clause:** Drop-down providing Call Manager option:
 - No Error
 - Unallocated Number
 - Call Rejected
 - Number Changed
 - Invalid Number Format
 - Precedence Level Exceeded
- **Call Classification:** Drop-down providing Call Manager option:
 - Offnet
 - OnNet
- **Allow Device Override:** Check box to enable device override.
- **Provide Outside Dial Tone:** Check box to enable Outside Dial Tone.
- **Allow Overlap Sending:** Check box to enable Overlap Sending.
- **Urgent Priority:** Check box to enable Urgent Priority.
- **Authorization Level:** Free text box to enter Authorization Level as numeric value.
- **Require Forced Authorization Code:** Check box to enable Forced Authorization Code.
- **Require Client Matter Code:** Check box to enable Client Matter Code.
- **Use Calling Party's External Phone Number Mask:** Drop-down providing Call Manager available options:
 - Default
 - On
 - Off
- **Calling Party Transform Mask:** Free text field to enter common Call Manager Transform Mask data.
- **Calling Party Prefix Digits (Outgoing Calls):** Free text field to enter common Call Manager Calling Party Prefix Digit data.
- **Called Party Discard Digits:** Drop-down providing Call Manager available options:
 - None
 - PreDot
 - PreDot Trailing-#

Note that more discard instructions may be added at market demand.

- **Called Party Transform Mask:** Free text field to enter common Call Manager Transform Mask data.
- **Called Party Prefix Digits (Outgoing Calls):** Free text field to enter common Call Manager Called Party Prefix Digit data.
- **Calling Line Presentation Bit:** Drop-down providing Call Manager available options:
 - Default

- Allowed
- Restricted
- **Calling Name Presentation Bit:** Drop-down providing Call Manager available options:
 - Default
 - Allowed
 - Restricted
- **Connected Line Presentation Bit:** Drop-down providing Call Manager available options:
 - Default
 - Allowed
 - Restricted
- **Connected Name Presentation Bit:** Drop-down providing Call Manager available options:
 - Default
 - Allowed
 - Restricted
- **MLPP Precedence:** Drop-down providing Call Manager available options:
 - Default
 - Executive Override
 - Flash
 - Flash Override
 - Immediate
 - Priority
 - Routine

15.6.15. Translation Pattern Model

The Translation Pattern dial plan model allows the administrator to define an unlimited number of Translation Patterns. “Local Dialing” flag will be covered in the following section.

Dp Trans Pattern				Add	Delete	Help	Action ▾
<input type="checkbox"/>	Dial Plan Name^	Local Dialing	Translation Pattern	Hierarchy			
<input type="checkbox"/>	Site_Level_DP	true	{{ input.areacode.areaCode}}XXXX	sys.hcs.VLS			
<input type="checkbox"/>	Site_Level_DP	true	{{ input.areacode.areaCode}}XXXXXXX	sys.hcs.VLS			

Dp Trans Pattern [Tiered_Cust_Level_DP]		Save	Delete	Help	Back	Action ▾
Dial Plan Name	Tiered_Cust_Level_DP					
Local Dialing	<input type="checkbox"/>					
Translation Pattern	656XXXXXXX					
Partition	{{ macro.DP_CustomerName }}-LD-PT					
Translation Pattern Description	656 digit dialing translation pattern					
CSS	{{ macro.DP_CustomerName }}-INTERNAL-CSS					
Use Originator's Calling Search Space	<input type="checkbox"/>					
Route Option	Route this pattern					
Release Clause	No Error					
Provide Outside Dial Tone	<input checked="" type="checkbox"/>					
Urgent Priority	<input type="checkbox"/>					
Do Not Wait For Interdigit Timeout On Subsequent Hops	<input type="checkbox"/>					
Route Next Hop By Calling Party Number	<input type="checkbox"/>					
Use Calling Party's External Phone Number Mask	<input type="checkbox"/>					
Calling Party Transform Mask						
Calling Party Prefix Digits (Outgoing Calls)						
Calling Line Presentation Bit	Default					
Calling Name Presentation Bit	Default					
Connected Line Presentation Bit	Default					
Connected Name Presentation Bit	Default					
Called Party Transform Mask						
Called Party Discard Digits						
Called Party Prefix Digits (Outgoing Calls)						

Translation Pattern fields:

- **Dial Plan Name:** Drop-down driven unique name given to the entire dial plan as a whole. This name appears in every dial plan model type.
- **Local Dialing:** Check box to identify special patterns.
- **Translation Pattern:** Free text field to enter a common Call Manager translation pattern.
- **Partition:** Free text field to enter a valid partition for the Translation Pattern.
- **Translation Pattern Description:** Meaningful description of the Translation Pattern.

- **Css:** Free text field to assign a valid CSS per the dial plan.
- **Route Option:** Drop-down providing Call Manager options:
 - Route this pattern
 - Block this pattern
- **Release Clause:** Drop-down providing Call Manager options:
 - No Error
 - Unallocated Number
 - Call Rejected
 - Number Changed
 - Invalid Number Format
 - Precedence Level Exceeded
- **Provide Outside Dial Tone:** Check box to enable Outside Dial Tone.
- **Urgent Priority:** Check box to enable Urgent Priority.
- **Do Not Wait For Interdigit Timeout On Subsequent Hops:** Check box to bypass interdigit timeout.
- **Route Next Hop By Calling Party Number:** Check box to enable Route Next Hop By Calling Party Number.
- **Use Calling Party's External Phone Number Mask:** Check box to enable use of Calling Party's External Phone Number Mask.
- **Use Originator's Calling Search Space:** Check box to enable Originator's Calling Search Space.
- **Calling Party Transform Mask:** Free text field to enter common Call Manager Transform Mask data.
- **Calling Party Prefix Digits (Outgoing Calls):** Free text field to enter common Call Manager Calling Party Prefix Digit data.
- **Calling Line Presentation Bit:** Drop-down providing Call Manager available options:
 - Default
 - Allowed
 - Restricted
- **Calling Name Presentation Bit:** Drop-down providing Call Manager available options:
 - Default
 - Allowed
 - Restricted
- **Connected Line Presentation Bit:** Drop-down providing Call Manager available options:
 - Default
 - Allowed
 - Restricted
- **Connected Name Presentation Bit:** Drop-down providing Call Manager available options:
 - Default
 - Allowed

– Restricted

- **Called Party Transform Mask:** Free text field to enter common Call Manager Transform Mask data.
- **Called Party Prefix Digits (Outgoing Calls):** Free text field to enter common Call Manager Called Party Prefix Digit data.

15.6.16. Route Pattern and Translation Pattern ‘Local’

The Translation/Route Pattern local designation in dial plan model allows the administrator to define patterns as local or looping patterns from the Site/Customer dial plan input sheet. The dial plan input sheets allow for creating a list of local area code/exchange that can be referenced via macro values to create site or customer level unique patterns.

Dp Route Pattern [Site_Level_DP] Save Delete Help Back Action ▾

Dial Plan Name Site_Level_DP ▾

Local Dialing

Route Pattern {{ macro.DP_PSTNAccess }}-{{ macro.DP_AreaCode }}XXXXXX

Route Pattern Description 10 digit Digit Local

Route Partition {{ macro.SITENAME }}-LD-PT

Numbering Plan

Route Filter

Route List {{ macro.SITENAME }}-AGGR-RL

Gateway Name

Route Option Route this pattern ▾

Release Clause No Error ▾

Call Classification OffNet ▾

Dp Trans Pattern [Site_Level_DP] Save Delete Help Back Action ▾

Dial Plan Name Site_Level_DP ▾

Local Dialing

Translation Pattern {{ macro.DP_PSTNAccess }}-{{ macro.DP_AreaCode }}XXXX

Partition {{ macro.SITENAME }}-LD-PT ▾

Translation Pattern Description 7 digit dialing translation pattern

Css {{ macro.SITENAME }}-INTERNAL-CSS ▾

Use Originator's Calling Search Space

Route Option Route this pattern ▾

Release Clause No Error ▾

15.6.17. CTI Route Points

The CTI Route Point dial plan model allows the administrator to define an unlimited number of CTI Route points with an associated line.

Dp Cti Route Point				Add	Delete	Help	Action ▾
■	Dial Plan Name	Device Name	Description	Hierarchy			
■	Site_Level_DP	TestCTIRP1	Test CTI Route Point 1	sys.hcs.VLS			
■	Site_Level_DP	TestCTIRP2	Test CTI Route Point 2	sys.hcs.VLS			
■	Tiered_Cust_Level_DP	TestCTIRP1	Test CTI Route Point 1	sys.hcs			
■	Tiered_Cust_Level_DP	TestCTIRP2	Test CTI Route Point 2	sys.hcs			

Dp Cti Route Point [Tiered_Cust_Level_DP]		Save	Delete	Help	Back	Action ▾
CTI Route Point		Associated Line				
Dial Plan Name*	Tiered_Cust_Level_DP ▾					
Device Name*	TestCTIRP1					
Description	Test CTI Route Point 1					
Device Pool*	Default					
Calling Search Space	{{ macro.DP_CustomerName }}-LD-CSS ▾					
Location	Hub_None					
Use Trusted Relay Point*	Default ▾					
Calling Party Transformation CSS	{{ macro.DP_CustomerName }}-LD-CSS ▾					
Geolocation	unspecified					
Use Device Pool Calling Party Transformation CSS	<input checked="" type="checkbox"/>					

CTI Route Point Device fields:

- **Dial Plan Name:** Drop-down driven unique name given to the entire dial plan as a whole. This name appears in every dial plan model type.
- **Device Name:** The unique device name assigned to the CTI Route Point.
- **Description:** Meaningful description of the CTI Route Point.
- **Device Pool:** Free text field to enter the proper device pool for the CTI Route Point.
- **Css:** Drop-down field that provides a list of CSS from the dial plan css model.
- **Location:** Free text field to assign a valid Call Manager Location
- **Use Trusted Relay Point:** Drop-down with values:

- Default
- Off
- On
- **Calling Party Transformation CSS:** Drop-down field that provides a list of CSS from the dial plan css model.
- **Geolocation:** Free text field to enter a geolocation if necessary.
- **Use Device Pool Calling Party Transformation CSS:** Check box to enable Use Device Pool Calling Party Transformation CSS.

Dp Cti Route Point [Tiered_Cust_Level_DP] Save Delete Help Back Action ▾

CTI Route Point Associated Line

CTI Route Point DN	<input type="text" value="1999"/>
CTI Route Point Line Description	<input type="text" value="Line 1999 CTI Route Point"/>
CTI Route Point Line Partition	<input type="text" value="{{ macro.DP_CustomerName }}-INTERNAL-PT"/>
CTI Route Point Line CSS	<input type="text" value="{{ macro.DP_CustomerName }}-LD-CSS"/>

CTI Route Point Line Fields:

- **CTI Route Point DN:** The back end system will take the input from this field and create the Internal Number Inventory entry marked as used, then create a CUCM Line with the input number then finally associate the newly created line to the CTI Route Point.
- **CTI Route Point Line Description:** Meaningful description of the CTI Route Point Line.
- **CTI Route Point Line Partition:** Drop-down field that provides a list of Partitions from the dial plan partitions model.
- **CTI Route Point Line CSS:** Drop-down field that provides a list of CSS from the dial plan css model.

15.6.18. Called Party Transformation Model

The Called Party Transformation dial plan model allows the administrator to define an unlimited number of Called Party Transformations.

Dp Called Party Transformation [Site_Level_DP]		Save	Delete	Help	Back	Action ▼
Dial Plan Name	Site_Level_DP					
Pattern*	**111					
Description	Transform 1111					
Route Partition	{{ macro.SITENAME }}-INTERNAL-PT					
Discard Digits						
Called Party Transformation Mask	2143360552					
Called Party Prefix Digits	3280					
Called Party Number Type	Cisco CallManager					
Called Party Numbering Plan	Cisco CallManager					

Called Party Transformation fields:

- **Dial Plan Name:** Drop-down driven unique name given to the entire dial plan as a whole. This name appears in every dial plan model type.
- **Pattern:** Free text field to allow entry in standard Call Manager patterns.
- **Description:** Meaningful description of the Called Party Transformation.
- **Route Partition:** Free text field for entry of a valid Call Manager Partition.
- **Called Party Discard Digits:** Drop-down providing Call Manager available options:
 - PreDot
 - PreDot Trailing-#

Note that more discard instructions may be added at market demand.

- **Called Party Transformation Mask:** Free text field for entry of transformation mask.
- **Called Party Prefix Digits:** Free text field for entry of prefix digits.
- **Called Party Number Type:** Drop-down providing Call Manager options:
 - Cisco CallManager
 - Unknown

- National
- International
- Subscriber
- **Called Party Numbering Plan:** Drop-down providing Call Manager options:
 - Cisco CallManager
 - ISDN
 - National Standard
 - Private
 - Unknown

15.6.19. Calling Party Transformation Model

The Calling Party Transformation dial plan model allows the administrator to define an unlimited number of Calling Party Transformations.

Dp Calling Party Transformation [Tiered_Cust_Level_DP]		Save	Delete	Help	Back	Action ▾
Dial Plan Name	Tiered_Cust_Level_DP ▾					
Pattern*	2143560001					
Description	Test calling Party TP					
Partition	{{ macro.DP_CustomerName }}-INTERNAL-PT					
Use Calling Party's						
External Phone	Default ▾					
Number Mask						
Calling Line ID						
Presentation*	Default ▾					
Calling Party						
Transform Mask	123456					
Calling Party Prefix						
Digits (Outgoing Calls)	9988					
Calling Party Discard						
Digits						
Calling Party Number						
Type*	Cisco CallManager ▾					
Calling Party						
Numbering Plan*	Cisco CallManager ▾					

Calling Party Transformation fields:

- **Dial Plan Name:** Drop-down driven unique name given to the entire dial plan as a whole. This name appears in every dial plan model type.
- **Pattern:** Free text field to allow entry of standard Call Manager patterns.
- **Description:** Meaningful description of the Called Party Transformation.
- **Partition:** Free text field for entry of a valid Call Manager Partition.
- **Use Calling Party's External Phone Number Mask:** Drop-down providing Call Manager available options:
 - Default
 - On
 - Off
- **Calling Line ID Presentation:** Drop-down providing Call Manager available options:

- Default
- Allowed
- Restricted
- **Calling Party Transform Mask:** Free text field to enter common Call Manager Transform Mask data
- **Calling Party Prefix Digits (Outgoing Calls):** Free text field to enter common Call Manager Calling Party Prefix Digit data.
- **Called Party Discard Digits:** Drop-down providing Call Manager available options:
 - PreDot

Note that more discard instructions may be added at market demand.

- **Called Party Number Type:** Drop-down providing Call Manager options:
 - Cisco CallManager
 - Unknown
 - National
 - International
 - Subscriber
- **Called Party Numbering Plan:** Drop-down providing Call Manager options:
 - Cisco CallManager
 - ISDN
 - National Standard
 - Private
 - Unknown

15.6.20. SIP Route Pattern Model

The SIP Route Pattern dial plan model allows the administrator to define an unlimited number of SIP Route Patterns.

Dp Sip Route Pattern [Tiered_Cust_Level_DP]		Save	Delete	Help	Back	Action ▼
Dial Plan Name*	Tiered_Cust_Level_DP					
Pattern*	sip:7654321@vls.com					
Description	SIP Route Pattern 7654321					
Usage*	Domain Routing					
Route Partition*	{{ macro.DP_CustomerName }}-LD-PT					
Route Option	Route this pattern					
Calling Party Transformation Mask						
Use Calling Party's External Phone Number Mask	Default					
Calling Party Prefix Digits (Outgoing Calls)						
Calling Line Presentation Bit	Default					
Calling Name Presentation Bit	Default					
Connected Line Presentation Bit	Default					
Connected Name Presentation Bit	Default					
Sip Trunk/Route List Name *	{{ macro.DP_CustomerName }}-AGGR-RL					
Dn or Pattern IPv6						
Route On User Part	<input type="checkbox"/>					
Use Caller CSS	<input checked="" type="checkbox"/>					
Domain Routing Css Name						

SIP Route Pattern fields:

- **Dial Plan Name:** Drop-down driven unique name given to the entire dial plan as a whole. This name

appears in every dial plan model type.

- **Pattern:** Free text field to allow entry in standard Call Manager patterns uri patterns.
- **Description:** Meaningful description of the SIP Route Pattern.
- **Usage:** Drop-down providing Call Manager options:
 - Domain Routing
- **Route Partition:** Free text field for entry of a valid Call Manager Partition.
- **Route Option:** Drop-down providing Call Manager options:
 - Route this pattern
 - Block this pattern
- **Calling Party Transform Mask:** Free text field to enter common Call Manager Transform Mask data
- **Use Calling Party's External Phone Number Mask:** Drop-down providing Call Manager available options:
 - Default
 - On
 - Off
- **Calling Party Prefix Digits (Outgoing Calls):** Free text field to enter common Call Manager Calling Party Prefix Digit data.
- **Calling Line ID Presentation:** Drop-down providing Call Manager available options:
 - Default
 - Allowed
 - Restricted
- **Calling Name Presentation:** Drop-down providing Call Manager available options:
 - Default
 - Allowed
 - Restricted
- **Calling Line Presentation Bit:** Drop-down providing Call Manager available options:
 - Default
 - Allowed
 - Restricted
- **Calling Name Presentation Bit:** Drop-down providing Call Manager available options:
 - Default
 - Allowed
 - Restricted
- **Connected Line Presentation Bit:** Drop-down providing Call Manager available options:
 - Default
 - Allowed
 - Restricted

- **Connected Name Presentation Bit:** Drop-down providing Call Manager available options:
 - Default
 - Allowed
 - Restricted
- **Sip Trunk/Route List Name:** Free text field for entry of a valid SIP Trunk or Route List Name.
- **Dn or Pattern IPv6:** Free text field for entry of Dn or Pattern IPv6.
- **Route On User Part:** Check box to enable Route On User Part.
- **Use Caller CSS:** Checkk box to enable use of Caller CSS.
- **Domain Routing Css Name:** Free text field for entry of a domain routing CSS.

15.7. Dial Plan Model Bulk Loader

Individual dial plans are meant to be established in the system with a bulk loader. Reference Bulk Loaders will be provided by VOSS staff for use in customer deployments. The key to dial plan for use with the tooling is the Dial Plan Name. This is the top entry in the dial plan model loader. Once a name is established it will carry down through the rest of the fields pertaining to the dial plan name.

Example of the dial plan model bulk loader:

	A	B	C	D	E	F	G	H	I	
1	##	Dial Plan Name								
2	entity: data/DP_DialPlan; parallel: False; parallel_transaction_limit: ; template:									
3		hierarchy	action	search_fields	device	template	ndf	pkid	dpName	
4		# Base							# DP_DialPlan	
5	# Comment	# Hierarchy Node	# Action	# Search Fields	# Device	# CFT Template	# Network Device List	# Unique Identifier	# Dial Plan Name	
6	0	sys.hcs	Add						Tiered_Cust_Level_DP Global Dial Plan E	
7	##									
8	##									
9	##	Device Pool - Region - Location - SRST Reference								
10	entity: data/DP_DP-Reg-Loc; hierarchy: sys; parallel: False; parallel_transaction_limit: ; template:									
11		hierarchy	action	search_fields	device	template	ndf	pkid	dpName	
12		# Base							# Device Pool	
13	# Comment	# Hierarchy Node	# Action	# Search Fields	# Device	# CFT Template	# Network Device List	# Unique Identifier	# Dial Plan Name	
14	0	sys.hcs	Add						Tiered_Cust_Level_DP {{ macro.DP_Cust	
15	##									
16	##									
17	##	Time Periods								
18	entity: data/DP_TimePeriod; hierarchy: sys; parallel: False; parallel_transaction_limit: ; template:									
19		hierarchy	action	search_fields	device	template	ndf	pkid	dpName	
20		# Base							# Time Period	
21	# Comment	# Hierarchy Node	# Action	# Search Fields	# Device	# CFT Template	# Network Device List	# Unique Identifier	# Dial Plan Name	
22	0	sys.hcs	Add						Tiered_Cust_Level_DP 01:00	
23	0	sys.hcs	Add						Tiered_Cust_Level_DP 07:00	
24	0	sys.hcs	Add						Tiered_Cust_Level_DP No Office Hours	

15.8. Dial Plan Log

Logs that will record any dial plan push/remove actions within the system. The information is read only and informational.

Dial Plan Log							
	Timestamp in UTC	Dial Plan	Dial Plan Action	Dial Plan Elements	Launched By	Action Hierarchy	Hierarchy
<input type="checkbox"/>	2017-06-29 20:05:57.931482	Site_Level_DP	push	all	VLSAdmin	sys.hcs.VLS.Tenant1.Vancouver	sys.hcs.VLS.Tenant1.Vancouver
<input type="checkbox"/>	2017-06-29 20:39:03.092865	Site_Level_DP	remove	all	VLSAdmin	sys.hcs.VLS.Tenant1.Vancouver	sys.hcs.VLS.Tenant1.Vancouver
<input type="checkbox"/>	2017-06-29 20:44:48.719970	Site_Level_DP	push	all	VLSAdmin	sys.hcs.VLS.Tenant1.Vancouver	sys.hcs.VLS.Tenant1.Vancouver
<input type="checkbox"/>	2017-06-29 20:47:13.973042	Site_Level_DP	remove	all	VLSAdmin	sys.hcs.VLS.Tenant1.Vancouver	sys.hcs.VLS.Tenant1.Vancouver
<input checked="" type="checkbox"/>	2017-06-29 20:48:13.449928	Site_Level_DP	push	all	VLSAdmin	sys.hcs.VLS.Tenant1.Vancouver	sys.hcs.VLS.Tenant1.Vancouver
<input type="checkbox"/>	2017-06-29 20:53:32.707848	Site_Level_DP	remove	all	VLSAdmin	sys.hcs.VLS.Tenant1.Vancouver	sys.hcs.VLS.Tenant1.Vancouver
<input type="checkbox"/>	2017-06-29 20:55:33.029889	Site_Level_DP	push	all	VLSAdmin	sys.hcs.VLS.Tenant1.Vancouver	sys.hcs.VLS.Tenant1.Vancouver

Dial Plan Log [2017-06-29 20:55:33.029889]

Timestamp in UTC	2017-06-29 20:55:33.029889
Dial Plan	Site_Level_DP
Dial Plan Elements	all
Dial Plan Action	push
Target Call Manager	["10.5.25.21", "8443", "hcs.VLS"]
Launched By	VLSAdmin
Action Hierarchy	sys.hcs.VLS.Tenant1.Vancouver

Log fields:

- Timestamp in UTS: The timestamp of the time the dial plan action was launched
- Dial Plan: The dial plan model applied
- Dial Plan Elements: Point to all or subset of dial plan elements.
- Dial Plan Action: Push or Remove
- Target Call Manager: The URI to the destination Call Manager
- Launched By: The administrator who submitted the request
- Action Hierarchy: The hierarchy level at which the action was launched.

15.9. Dial Plan Use Checklist

- Load Dial Plan Models for Global Values via bulk loader or JSON
- Load Dial Plan Models for Site Values via bulk loader or JSON
- Set Dial Plan Input Data for Global or Site level values. Only the fields that are referenced via Macro in the dial plan model must be populated.
- Push Global dial plan data to Call Manager using the Dial Plan Maintenance Tool. Be sure to check that the tool is run at the appropriate hierarchy level.

- Push Site level dial plan data at Call Manager using the Dial Plan Maintenance Tool. Be sure to check that the tool is run at the appropriate hierarchy level.
- Should any changes need to be made to the pushed dial plans, the tool does allow for removal in reverse order then a re-push once the dial plan models are updated.
- Set Site Defaults via the site default profile tool.

16. Microsoft Teams Dial Plan Management

16.1. Introduction to Microsoft Teams Dialplan Management

To view and update information related to Microsoft Teams dial plans, go to (default menu) **MS Teams Dial Plan Management**, and select the relevant menu:

- Tenant Dialplan
- SBC Gateways
- PSTN Usages
- Voice Routes
- Voice Routing Policies
- Voice Normalization Rules
- Translation Rules

16.1.1. Related Topics

- Microsoft Overview in the Core Feature Guide
- Sync with Flow Through in the Core Feature Guide
- VOSS-4-UC Configuration and Sync in the Core Feature Guide
- Configure Microsoft Tenant Dialplan in the Core Feature Guide
- Number Management Overview in the Core Feature Guide

16.2. Configure Microsoft Tenant Dialplan

This procedure displays and edits existing Microsoft Teams tenant dialplans and adds a new Microsoft Teams tenant dialplan.

Prerequisites:

- Add a Microsoft tenant

Perform these steps:

1. Log in to the Admin Portal.

2. Go to (default menu) **MS Teams Dial Plan Management > Tenant Dialplan**.
3. View existing tenant dialplans.
4. Do you want to ...
 - Edit an existing dialplan? Click on a dialplan to open the editing screen. Make your changes, then save the dialplan.
 - Add a new dialplan? Click the Plus icon (+) to open the New Record screen. Go to step 5.
5. On the **New Record** page, fill out details for the new Microsoft tenant dialplan:
 - In the **Name** field, fill out a unique name for the dialplan.
 - In the **Simple Name** field, fill out a unique display name for the dialplan.
 - In the **Description** field, describe the purpose and users of the dialplan.
 - In the **External Access Prefix** field, define a prefix used to identify external calls. To enable this prefix, select **Optimize Device Dialing**.
 - Select **Optimize Device Dialing** to enable the external access prefix.
 - At **Normalization Rules**, click the Plus icon (+) to add a normalization rule:
 - Provide a unique ID for the normalization rule, and a description.
 - Define the priority order of this rule, for phone numbers associated with two or more normalization rules.
 - In the **Pattern** field, provide a regular expression that a dialed number must match for the rule to be applied. The default is `^(d{11})$`, which represents any set of numbers up to 11 digits.
 - In the **Translation** field, define a regular expression to apply to the number to convert it to E.164 format. The default is `+$1`, which prefixes the number with a Plus (+).
 - Select **Is Internal Extension** if the number should be seen as internal when the rule is applied (set to True); else, clear the checkbox (False, default), so that the number is seen as external when the rule is applied.
 - To add additional normalization rules, click the Plus icon (+) and fill out values for the next normalization rule.
6. Click **Save** to create or update the tenant dialplan.

16.2.1. Related Topics

- Configure Microsoft Tenant in the Core Feature Guide
- Introduction to Microsoft Teams Dialplan Management in the Core Feature Guide
- Microsoft Overview in the Core Feature Guide
- Microsoft Configuration in the Core Feature Guide
- Sync with Flow Through in the Core Feature Guide
- VOSS-4-UC Configuration and Sync in the Core Feature Guide

17. Microsoft Teams Policies

17.1. Introduction to Microsoft Teams Policies

Microsoft Teams policies are synced between Microsoft Teams and VOSS-4-UC, to the customer level.

VOSS-4-UC provides an interface for managing Microsoft Teams policies. Updates in VOSS-4-UC are synced back to Microsoft Teams, and external changes are synced back to VOSS-4-UC.

Microsoft Teams policies are assigned automatically to subscribers via their user roles and profiles, and via quick add groups (QAG), as part of the initial sync and provisioning workflow.

To view or update Microsoft Teams policies, go to (default menu) **MS Teams Policies**; then, select the relevant menu:

- Upgrade Policy
- Calling Policy
- Meeting Policy
- Messaging Policy
- Meeting Broadcast Policy
- Call Park Policy

View and Update a Subscriber's MS Teams Policies

To view and update the policies of individual subscribers via the Subscriber edit functionality:

1. Go to (default menu) **Subscriber Management > Subscribers**.
2. Click on a subscriber to open the Subscribers [subscriber name] page.
3. Select the **MS Teams** tab.
4. View currently applied policies for the subscriber.
5. To choose different policies, click the down-arrow at the relevant policy, and select an alternative from the drop-down.
6. Save your changes. Policy changes are synced back to the Microsoft cloud when performing an overbuild or a sync.

Related Topics

- [Microsoft Overview in the Core Feature Guide](#)

18. Number Management

Important: For VOSS-4-UC release 21.1, refer to the *VOSS-4-UC 21.1 Release Changes and Impact* document for details on model and workflow changes. Customizations related to these changes may be affected.

The VOSS-4-UC 21.1 Release Changes and Impact PDF is available on the Documentation Portal.

18.1. Number Inventory

- Note: Underlined flowchart titles refer to topic headings in this guide.

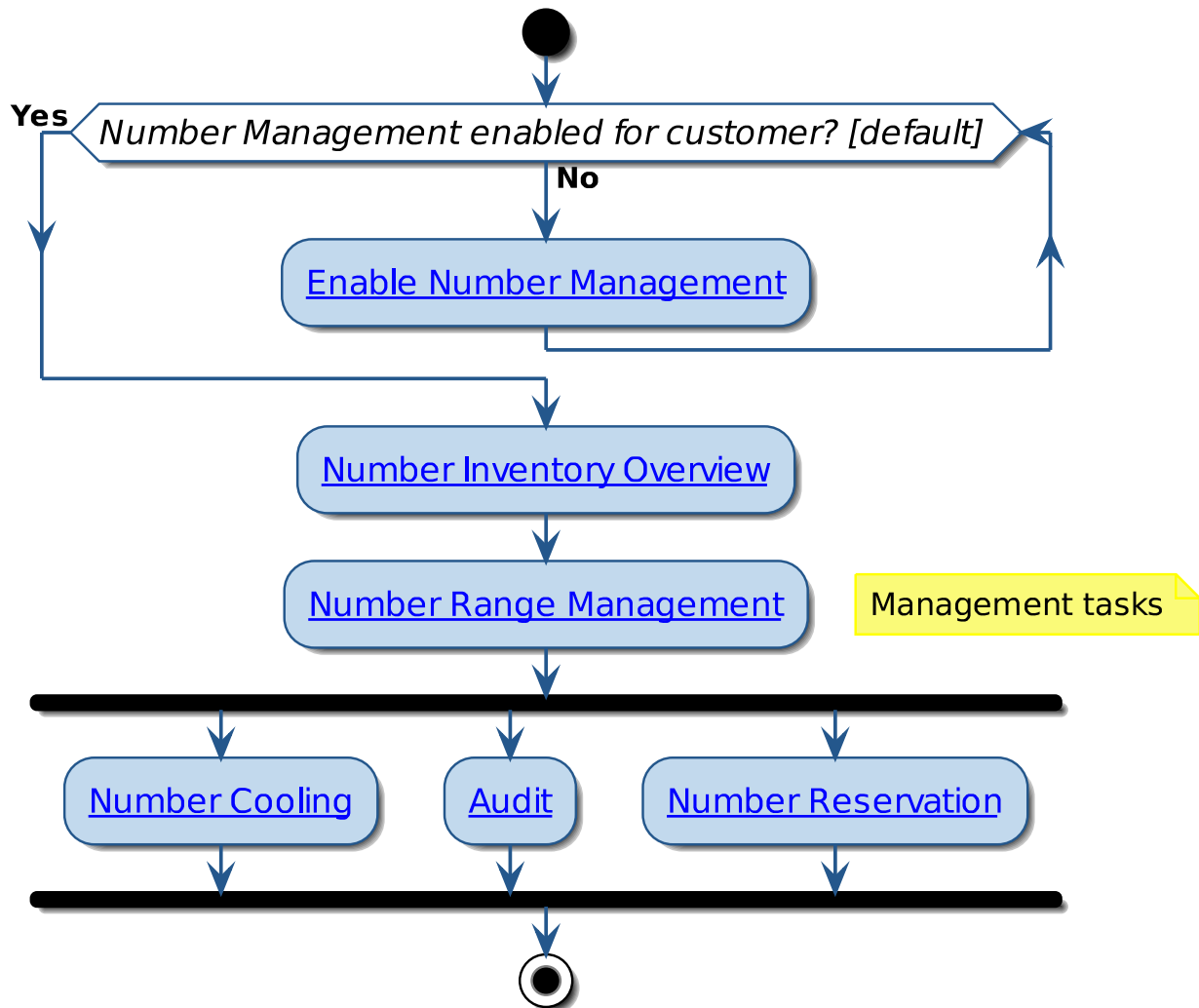

18.2. Number Inventory Overview

18.2.1. Overview

Number inventory allows you to view and manage the number inventory at the specified hierarchy level. It allows you to track numbers and to see how they are used in the system. This is done through a number of workflows to ensure the selection of numbers is limited to those available, and includes the ability to:

- Add, modify, and delete numbers
- View the status of numbers (Used, Used-Utility, Available, Reserved, Cooling).
- Store additional business data about the numbers.

Note:

- Internal numbers can't be added if **Number Management** is disabled for the customer. (See *Create and Modify a Customer*)

- Numbers created in the number inventory are in VOSS-4-UC only; they are not synced to Unified CM.

See Also:

- [Number Status and Usage](#)

18.2.2. Hierarchy

The number inventory can exist at a different hierarchy level to the lines for the users, services, and devices that consume them, which are typically at site level.

The inventory can also exist at customer level. This makes it easier if the allocation and availability of numbers is not site-specific. This saves moving numbers around sites to increase availability, and keeps a more central inventory of available numbers. It is also important if numbers are shared across sites. If you are a customer with multiple sites, ensure that the internal numbers you specify are unique across sites.

If the number allocation is site-specific, the numbers can be added or assigned to site level.

Number inventory can only exist at provider, customer, or site hierarchy. It is not applicable to the intermediate hierarchy.

18.2.3. Partition and Cluster

Number inventory is not partition or cluster aware. If the same numbers are used multiple times but in different partitions, then these all map to the same number. This should be taken into account when thinking about the hierarchy level at which the number inventory exists.

Also, not being cluster aware, if the same number exists on different clusters, this again will map back to the same inventory value unless numbers are assigned to the site level.

18.2.4. Reservation

Numbers can be reserved for future use. For example, for users who will soon be joining the company. When a number is reserved, it is unavailable and cannot be allocated to a subscriber, phone, device, etc. See also: [Number Reservation](#).

18.2.5. Number Cooling

Numbers can be placed into a cooling period, either manually or automatically. When automated number cooling is enabled, numbers are placed into cooling for a predefined period when the subscriber or phone associated with the number is deleted.

Note: Automated number cooling is enabled and disabled in the [Global Settings](#). The default is disabled.

While the number is in its cooling period, it is unavailable and cannot be allocated, for example, to a subscriber, phone, or device.

A number is released from cooling and is available for use when:

- The cooling period reaches its end date

- It is manually released from the cooling period

See also:

- [Number Cooling](#)

18.2.6. Number Inventory entries - End-user Provisioning Tasks

For more information on provisioning each of these tasks, refer to the relevant topics in the VOSS-4-UC Core Feature Guide.

Task	Menu Default Location	Notes
Lines	Subscriber Management > Lines	When lines are added through phones and subscriber, line details can be modified. The number for the line cannot be modified; if you attempt to change the number assigned to the line, the operation fails.
Phones	Subscriber Management > Phones > Lines tab > Dirn > Pattern	The Dirn > Pattern contains a list of available numbers. Numbers that are used are marked as “Used” in the Number Inventory. Only available numbers are listed.
Subscribers	Subscriber Management > Subscribers > Phones > Lines > Dirn	The Dirn > Pattern contains a list of available numbers. Numbers that are used are marked as “Used” in the Number Inventory. Only available numbers are listed.
	Subscriber Management > Subscribers > Voicemail	The “Voicemail Line” list contains numbers provisioned to lines.
Quick Add Subscribers	Subscriber Management > Quick Add Subscriber > Lines > Directory Number	The Number Inventory list contains available numbers. Numbers that are used are marked as “Used” in the Number Inventory. Only available numbers are listed.
PLAR (Hotdial)	Subscriber Management > PLAR (Hotdial)	Numbers provisioned to lines are displayed in the Hotdial Destination Pattern list. Numbers that are used are marked as “Used-Utility” in the Number Inventory.
Hunt Groups	Subscriber Management > Hunt Groups > Members > Directory Number	Numbers provisioned to lines are displayed in the Pattern list. Numbers that are used are marked as “Used-Utility” in the Number Inventory.
Call Pickup Groups	Subscriber Management > Call Pickup Groups > Call Pickup Group > Line	Numbers provisioned to member lines are displayed in the Pattern list. Numbers that are used are marked as “Used-Utility” in the Number Inventory.

18.3. Number Inventory List View

The **Number Inventory** list view (default menu **Number Management > Number Inventory**) displays the range of numbers that have been defined for the selected hierarchy.

Here you can view the list of numbers, delete a number, or select a number and edit the free text fields. Filter the numbers (by column) as needed.

The following columns are available:

- **Status = Available** and **Usage** is empty when a number is first added to the number inventory. Refer to [Number Status and Usage](#) for more information.
- **Release Date** (if cooling is enabled) indicates the date on which a number currently in status **Cooling**, becomes **Available** again. See: [Number Cooling](#).
- **Tag** is a free text field, which is populated when adding a new number or range of numbers. It is used to identify or comment on a number or number range.
- **Reservation notes** is a free text field, typically used to provide more details about a status **Reserved** number. See: [Number Reservation](#).
- **Vendor** field is an optional field typically used to designate vendor specific information for a device in a multi vendor setup.
- **Description** as well as **Extra1** to **Extra6** fields are free text fields that are available to provide additional information for a given number or range of numbers.

You can manage a specific number by clicking on the number in the list view. See: [Number Range Management](#).

18.4. Number Status and Usage

Administrators can now view more accurate data as to how numbers are used at a specific hierarchy level.

The **Status** and **Usage** columns on the enhanced **Number Inventory** form (default menu **Number Management > Number Inventory**) are described below:

Number Use	Device	Status	Usage
Not used by anything	-	Available	blank
Phone Line ¹	device/cucm/Phone (line instance)	Used	Device
Device Profile Line	device/cucm/DeviceProfile (line instance)	Used	Device
Remote Destination Profile Line	device/cucm/RemoteDestinationProfile (line instance)	Used	Device
Hunt Pilot ^{Page 483, 1}	device/cucm/HuntPilot	Used-Utility	Hunt_Pilot
Pickup Group Pilot	device/cucm/CallPickupGroup	Used-Utility	Pickup_Group_Pilot
System Call Handler	device/cuc/Callhandler (System only)	Used-Utility	Call_Handler_Pilot
Voicemail Pilot	device/cucm/VoicemailPilot	Used-Utility	Voicemail_Pilot
Meet Me	device/cucm/MeetMe	Used-Utility	Meet_Me
CTI Route Point	device/cucm/CtiRoutePoint	Used-Utility	CTI_RoutePoint
Call Park	device/cucm/CallPark	Used-Utility	Call_Park
Directed Call Park	device/cucm/DirectedCallPark	Used-Utility	Directed_Call_Park
VOSS Phone	data/GS_Shout_MultiVendorPhone_DAT	Used-Utility	VOSS_Phone
Number in cooling ²		Cooling	-
Number reserved ³		Reserved	-

18.4.1. Details and Usage

Selecting a specific number from the **Number Inventory** list view, opens the details view for that number.

The **Number Details** tab shows read only details for the number, for example Internal Number, Status, Usage, as well as editable fields such as Tag, Description, Reservation Notes, etc.

The **Usage** tab provides links to all instances where the number is used.

Note: If the same number is shared by multiple devices/services of the same type, using different partitions, only the first 10 instances will be displayed.

¹ If a number is used by both a Phone and Hunt Pilot then the **Usage** column will display both usage values, i.e. `Device, Hunt_Pilot`. However, the **Status** column will display only **one** status, i.e. the status triggered by the most recent transaction.

² If a number is currently in **Cooling**, the release date indicates when the number will come out of cooling.

³ If a number is currently **Reserved**, you can enter an optional **Tag** to identify the user for which the number is reserved. An optional **Reservation notes** field is also available to allow you to enter additional information regarding the reserved number.

18.5. Number Range Management

18.5.1. Number Ranges Overview

The Number Range management feature allows you to create a range of internal numbers at a customer or site level.

When a range is added that includes existing numbers, these can not be modified. The new unused numbers will be added only to complete the range. In other words, the range will show up as complete, with unused numbers in between numbers imported from Unified CM.

Number ranges can also be deleted. Numbers in the range that have a status of **Used**, **Used-Utility**, **Reserved** or **Cooling** will be ignored and can not be deleted. If these numbers are modified to the **Available** status, and not in use, they can then be deleted. The **Available** and **Reserved** status of numbers can also be modified manually once they are added.

Note:

- Using bulk loader sheet or API, you can create the number inventory at the customer hierarchy only. The **Details** column of sub-transactions shows whether the number already exists or if it is creating a new number. If any numbers exist in the range, the sub-transaction fails and the parent transaction shows the status Success with Async Failures.
-

18.5.2. Add, Modify or Delete a Number or Number Range

Numbers can be added or deleted. When *modifying* a number, you can only edit the free text fields. The usage and availability property for each number is associated with a line or taken into use by a service.

Since the number inventory is not partition aware, if the same directory number is used on a cluster but in different partitions, then VOSS-4-UC workflows will update the inventory when *any* of those instances are changed. For instance, if there is a number 1111 in the Cluster X partition and a number 1111 in the Cluster Y partition, then the number is marked as **Used**.

If one of those instances are deleted, we check to see if there are other instances of that line based on the number only (not partition), before clearing the **Used** flag. In this case, the other instance will be found and the inventory will stay marked as **Used**.

1. Browse to the hierarchy at which you want manage the number range.
2. Open the **Number Range Management** form (default menu **Number Management > Number Range Management**) and choose the target site from the **Target Site** drop-down (only applicable to Customers using an SLC-based dial plan).
3. From the **Operation** drop-down, choose **Add**, **Modify** or **Delete**.

Note:

- When adding or modifying a number range, the **Status** of the numbers is **Available** by default. However you can change this to **Reserved** from the **Status** drop-down. If set to **Reserved**, you can also enter the **Reservation duration (days)** value, e.g. 30, after which period the number/s will return to the **Available** status. If this value is left blank, the number/s will be reserved indefinitely. See also [Number Reservation](#).

- When deleting a number range, lines cannot be marked as **Available** or **Reserved**, and the check boxes are hidden.

4. Enter the **Starting Extension** and **Ending Extension**. The maximum allowed range is 1000 for a single action. The starting extension should always be smaller than the ending extension.

If you are adding or deleting a single number, the starting and ending extension number will be the same. If numbers in the range already exist, they will not be affected - only non-existing numbers will be added.

5. Edit free text fields, for example **Tag**, **Description**, **Reservation notes E164Number** (if applicable), and **Extra1** to **Extra6**.

6. Click **Save** to save the single or range of numbers that you added, modified or deleted. If a number in a deleted range was set as **Used**, it will not be deleted.

The numbers at a specific hierarchy can be viewed on the **Number Inventory** list view (default menu **Number Management > Number Inventory**). See [Number Inventory List View](#).

When a line is added and selected from the drop-down list of available numbers, it has a status of **Used**. If the line is used by a device or service that does not allow a shared line (for example, a Hunt Pilot), it has a status of **Used-Utility**. See [Number Status and Usage](#).

If number cooling is enabled, deleted numbers are automatically placed into a cooling period as specified in [Global Settings](#). During this period the number cannot be used.

Internal numbers are available when adding subscribers.

18.5.3. Modify an individual number

You can also modify an individual number from the list view ([Number Inventory List View](#)) by selecting it.

1. Click **Reserve Number** on the button bar of the number instance form to reserve it.
2. Edit free text fields, for example: **Tag**, **Description**, **Reservation notes**, **E164Number** (if applicable), and **Extra1** to **Extra6**.
3. Click **Save**.

18.6. Number Cooling

18.6.1. Cooling Overview

Number cooling allows for the automatic aging of numbers after service delete to prevent immediate reuse of a number. For example, if a user leaves the company, the phone number that was in use can be placed into a cooling period for a pre-configured number of days to prevent a new user from receiving unwanted calls on that number. This feature can be enabled per hierarchy level.

Note: Number cooling is enabled and configured in [Global Settings](#).

During the cooling period, the number cannot be reused until either the cooling period has elapsed, or until a provider administrator has manually removed the number from the cooling period. Once a number has been

removed from the cooling period, it will be reintroduced into the pool of available numbers for allocation to a subscriber, phone, device, etc.

A number cooling auto expiry schedule runs daily. This schedule polls the cooling **Release Date** field on the number inventory list view to determine which numbers have completed their cooling period. These numbers are then returned to the list of available numbers at the specific hierarchy level. For more details refer to “Number Cooling Auto Expiry Schedule” in the *Advanced Feature Guide*.

The **Cooling & Reservation** form (default menu **Number Management > Cooling & Reservation**) allows a provider administrator to manually add numbers to a cooling period (thereby *removing them from* the list of available numbers), or to manually remove numbers from a cooling period (thereby *adding them back to* the list of available numbers).

 [Enable Cooling](#)

 [Manage Cooling](#)

18.6.2. Apply cooling

1. Navigate to the required hierarchy level (Provider, Customer or Site) from which you want to add numbers to a cooling period.
2. On the **Cooling & Reservation** form, choose **Apply cooling** from the **Select action** drop-down.
3. Enter an optional cooling duration in days (max = 999) to apply to the selected numbers. This setting overrides the value set in their global settings. If this field is left blank, then the cooling duration set in [Global Settings](#) for each number will apply.
4. Set **Filters** to determine which numbers will be included in the **Available** box in the **Select Numbers** area, these include:
 - **Include available numbers**
 - **Include cooling numbers**
 - **Contains.** Used to further refine the numbers displayed in the **Available** box.
 - **Show numbers at/below hierarchy.** Allows you to select a lower hierarchy level than the one selected on the hierarchy breadcrumb.
5. Select one or more numbers in the **Available** box and click **Select** to move them to the **Selected** box. Note that the **Available** box will not display numbers that are used, i.e. it will only display numbers that are unused and available.
6. Click **Save**. The selected number(s) are placed into a **Cooling** status, and are no longer available for use until they reach either the **Release Date** or until they are manually removed from cooling.

18.6.3. Remove from cooling

1. Navigate to the required hierarchy level (Provider, Customer or Site) from which you want to remove numbers from a cooling period, i.e. add them back into the list of available numbers.
2. On the **Cooling & Reservation** form, choose **Remove from cooling** from the **Select action** drop-down.
3. Set **Filters** to determine which numbers will be included in the **Available** box in the **Select Numbers** area, these include:
 - **Include cooling numbers**
 - **Expires from cooling within (days).**
 - **Contains.** Used to further refine the numbers displayed in the *Available* box.
 - **Show numbers at/below hierarchy.** Allows you to select a lower hierarchy level than the one selected on the hierarchy breadcrumb.
4. Select one or more numbers in the **Available** box and click **Select** to move them to the **Selected** box.
5. Click **Save**. The selected number(s) are removed from the cooling period and are available for allocation to a subscriber or phone, etc.

See also:

- [Global Settings](#)
- [Number Inventory Overview](#)
- [Audit Number Inventory](#)
- Number Cooling Auto Expiry Schedule in the Advanced Configuration Guide

18.7. Number Reservation

18.7.1. Reservation Overview

The Reservation feature allows numbers to be reserved for future use. Reserved numbers cannot be allocated to a device or line.

The **Cooling & Reservation** list view (default menu **Number Management > Cooling & Reservation**) allows a provider administrator to manually reserve numbers at the selected hierarchy (Provider, Customer or Site) for a specified number of days. While a number is within the **Reservation duration (days)** period, it is unavailable and cannot be used by a device or line.

If the **Reservation duration (days)** period is left blank, the numbers remain in the **Reserved** status. Currently reserved numbers can be unreserved manually, thereby *adding them back* to the list of available numbers.

 [Reserve Number](#)

 [Manage Cooling](#)

18.7.2. Reserve numbers

1. Navigate to the required hierarchy level (Provider, Customer or Site) from which you want to reserve numbers.
2. On the **Cooling & Reservation** form, choose **Reserve** from the **Select action** drop-down.
3. In the *Reservation duration (days)* field, enter the number days for which you want to reserve the numbers.
4. Enter **Reservation Notes** for the reserved numbers to describe why the numbers are being reserved. This is displayed in the **Reservation notes** field on the **Number Inventory** list.
5. Set **Filters** to determine which numbers will be included in the **Available** box in the **Select Numbers** area:
 - **Include available numbers**
 - **Include reserved numbers**
 - **Contains.** Used to further refine the numbers displayed in the *Available* box.
 - **Show numbers at/below hierarchy.** Allows you to select a lower hierarchy level than the one selected on the hierarchy breadcrumb.
6. Select one or more numbers in the **Available** box and click **Select** to move them to the **Selected** box.
7. Click **Save**. The selected number(s) are placed into a **Reserved** status, and are no longer available for allocation to a subscriber or phone, etc.

Note: Individual numbers can also be reserved directly from the **Number Inventory** list view (default menu **Number Management > Number Inventory**) by clicking on the required number on the list view and then selecting **Reserve Number** on the button bar.

18.7.3. Unreserve numbers

1. Navigate to the required hierarchy level from which you want to unreserve numbers, i.e. add them back into the list of available numbers.
2. On the **Cooling & Reservation** form, choose **Unreserve** from the **Select action** drop-down.
3. Set **Filters** to determine which numbers will be included in the **Available** box in the **Select Numbers** area:
 - **Include reserved numbers**
 - **Contains.** Used to further refine the numbers displayed in the *Available* box.
 - **Show numbers at/below hierarchy.** Allows you to select a lower hierarchy level than the one selected on the hierarchy breadcrumb.
4. Select one or more numbers in the **Available** box and click **Select** to move them to the **Selected** box.
5. Click **Save**. The selected number(s) are removed from the **Reserved** status, and are available for allocation to a subscriber or phone, etc.

See also:

- [Number Inventory Overview](#)
- [Audit Number Inventory](#)

- *Number Cooling*

18.8. Audit Number Inventory

Note: You cannot run **Audit Number Inventory** if number management has been disabled for the customer (see *Create and Modify a Customer*).

This feature performs an audit of the number inventory and makes sure that the **Status** and **Usage** of each number aligns to the devices or services configured with these matching numbers. See *Number Status and Usage* for more details about these values.

The audit will create new numbers for devices or services that don't already exist, as well as update existing number entries to make sure the **Status** and **Usage** fields reflect the correct information at the time the audit is run. Number entries **will not be deleted**.

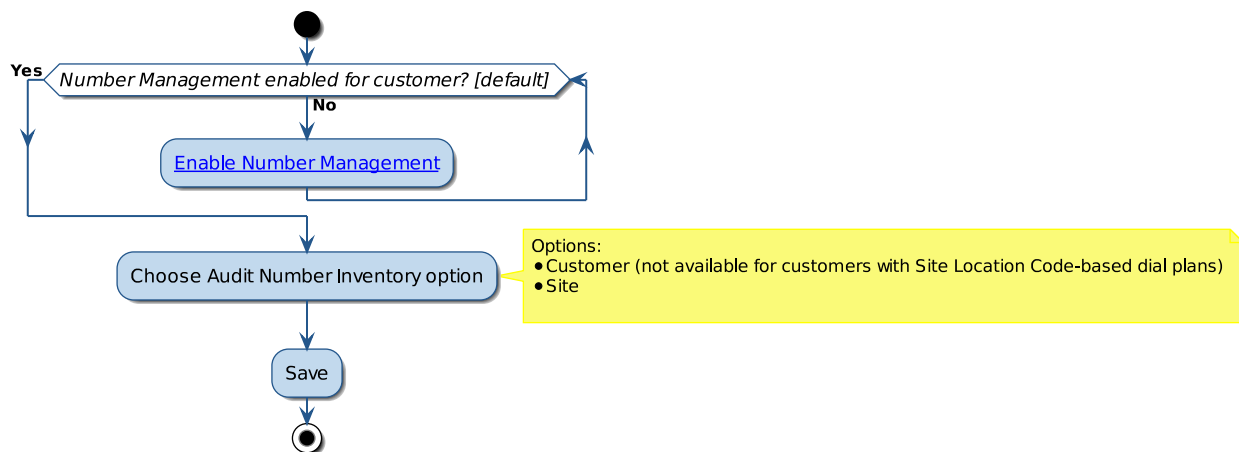

Specify where you want to run and create a new number inventory:

- **Customer**

- Running the number inventory audit at **Customer** level will add directory numbers at Customer level for services which exist at Site or Customer, **provided there is not** already a directory number for that service at Site level. If there are already directory numbers at the Site level then those will also get updated.

This is a mixed mode of audit, which audits directory numbers at both Customer and Site level. For example, if directory numbers only exist at Customer level, then the audit will only add and update directory numbers that exist at the Customer. If there are directory numbers at Site level, the audit will still add new directory numbers at the Customer level, but will also update the existing directory numbers at Site level.

- **Site**

- Running the number inventory audit at **Site** level will add directory numbers at site level, and update any existing directory numbers at site level only. No Customer level directory numbers will be audited and no directory numbers will be added to Customer level for Customer level services.
- You can choose to audit either *All* the Sites for the Customer or selected Sites.

For sites using Site Location Code-based dial plans, number inventories can be created only at the site hierarchy, the customer hierarchy will not be available.

From the **Number Inventory** form (default menu **Number Management > Number Inventory**), you can see a list of internal numbers and move, delete, and export them as desired.

18.8.1. Common Errors and Caveats

- Error: Duplicate device profiles (same profile name) in different clusters.
Resolution: Ensure device profiles are not duplicated across the sites.
- Error: Duplicate phones (same MAC) in different clusters.
Resolution: Ensure phones are not duplicated across the clusters
- Error: Same internal number in one or more clusters.
Resolution: Ensure internal numbers (even in different partitions) are not duplicated across clusters.
- Numbers that are in a Cooling or Reserved state will not be audited.

18.8.2. Run Audit Number Inventory

Note: You can only run **Audit Number Inventory** from a customer hierarchy. If you try to run it from a hierarchy that is not of type Customer, you will be prompted to choose a valid customer hierarchy.

1. Log in to VOSS-4-UC as provider or reseller administrator.
2. Open the **Audit Number Inventory** form (default menu **Number Management > Audit Number Inventory**).
3. Browse to the customer hierarchy at which you want to run **Audit Number Inventory**.
4. Choose either **Customer** or **Site** from the **Is Number Inventory deployed at Customer or Site Level ?** drop-down.
5. If you chose **Customer**, click **Save** to run **Audit Number Inventory** at all sites that are located under the selected customer.
6. If you chose **Site**, choose either **All** from the **Would you like to audit all sites or a subset of sites ?** to run **Audit Number Inventory** at all the sites under the selected customer, *or* choose **Specific** and specify the sites on which you want to run **Audit Number Inventory** (200 maximum).
7. Click **Save**. The number inventory is updated at the hierarchy you specified and below.

19. Unity SIP Integration

19.1. Overview

19.1.1. Introduction

The Unity SIP Integration tooling provisions complete SIP integration between redundantly deployed Cisco Call Managers (CUCM) and Cisco Unity Connection (CUC) servers. This integration tooling can be used to define the primary only integration that the legacy Voicemail Service provides.

The integration tooling provides a repeatable process to manage the integration of CUCM and CUC, while also providing the ability to:

- Define the dial plan used for integration so that the administrator deploying the integration does not need to have dial plan knowledge.
- Override the dial plan input mechanism mentioned above for advanced deployment.
- Deploy CUCM and CUC SIP integration in full redundancy supporting optional tenants.

Important: Contact your dedicated VOSS support representative for details on how to set up and configure the Unity SIP Integration feature.

Note: If this feature is not exposed in the Admin Portal menu layout, refer to the Optional Features Appendix: Unity SIP Integration - Menu Layout Changes and Access Profile Changes.

Unity SIP Integration Scope

The Unity SIP Integration tooling provides support for:

- Dual trunks to Unity publisher/subscriber
- Multiple SIP server destinations to CUCMs (SIP redundancy)
- Specifically defined number of Unity port build per Unity node
- Dynamic creation of CUCM route list/route group or the ability to update if they already exist
- Creation of Unity tenants for shared architectural deployments
- Creation of Unity integration utilizing tenants
- Support for multi-cluster deployments

19.2. Administration GUI Menus

19.2.1. Unity SIP Integration

The Unity SIP Integration feature can be used in place of your existing voicemail service. A list of menu items is available to carry out the Unity SIP Integration tasks. Unity SIP Integration provides SIP integration for both CUCM and CUC.

A typical workflow would be that one or more integration dial plan profiles are set up for use, and then a SIP Unity Integration is pushed to CUCM and CUC.

Menu Name	Description and Notes
Integrate Unity-CallManager	The main tool used to push integration between CUCM and CUC.
Remove Integrate Unity- Call-Manager	This allows you to remove the complete integration out of the target CUCM and CUC.
Dial Plan Profile	This allows an advanced administrator to define all of the dial plan elements that make up the CUC integration, for example device pools, route group, route list, CSSs, and so on.
Integration Log	This log is populated with information about when the integration was pushed, as well as other details, so that it can be pulled back out again.
Unity Tenant Management	A “tenant” is basically a small voicemail setup for a sub-company within your larger Connection server. In other words if you had companies sharing a single connection server for voicemail services, you can set each one up as a separate “tenant” in your install which effectively isolates them from one another. Note that a Unity server containing user data without tenants cannot have tenants added after the fact.
Unity Tenant Add	This allows you to add a unity tenant to the Unity server.
Unity Tenant Delete	This allows you to remove a unity tenant from the Unity server.

19.2.2. Integrate Unity-Call Manager

This option allows you to create a SIP Integration between Cisco Unified Call Manager (CUCM) and Cisco Unity Connection (CUC).

Base

Note: Prior to completing this form, the **Provisioning Target Call Manager**, the **Provisioning Target Unity**, and the **Voicemail Service Dial Plan Profile** must be set. Based on these selections, other key values are auto populated on the form.

Complete, at minimum, the mandatory fields (red border):

UC Publisher Application Selection

- **Provisioning Target Call Manager** - Choose from the drop-down list.
- **Provisioning Target Unity** - Choose from the drop-down list.

Deployment Options

- **Voicemail Service Dial Plan Profile** - Choose from the drop-down list.
- **Dial Plan Advanced Mode** - Select this check box to unlock the fields for dial plan elements. You then have the ability to update those values 'live'.

Clear the check box to return the dial plan elements to the default voicemail dial plan profile values. This check box can be hidden from lower level administrators.

- **Provision CUCM-Unity in Redundant Mode** - Clear this check box for the feature to function in single mode, that is to operate in a similar way to the original voicemail service (Publisher only and no Subscriber trunk).

Select this check box to provision in redundant mode. In this mode, you can configure ports on both the Publisher and Subscriber Unity nodes, as well as build a trunk to both Publisher and Subscriber.

- **Unity Tenant(s) Present** - If the selected 'Provisioning Target Unity' server (see under **UC Publisher Application Selection** above) has tenants on it, this check box is automatically selected.

CUCM Global

- **SIP Profile** - To assign the configured settings in this SIP profile to the associated device.
- **SIP Trunk Security Profile** - To assign a single security profile to multiple SIP trunks in order to apply the configured settings to the SIP trunks.

These fields are auto populated based on the **Voicemail Service Dial Plan Profile** chosen under **Deployment Options**.

Unity Port Group

Complete, at minimum, the mandatory fields (red border):

- **Phone System** - Choose from the drop-down. The phone system settings identify the phone system with which Unity Connection integrates and regulate certain phone system features (integration configuration settings are located in the port groups that belong to the phone system.)
- **SIP Server Authentication Username** - Enter the user name that Unity Connection uses to authenticate with the SIP server (SIP integrations only).
- **SIP Server Authentication Password** - Enter the password that Unity Connection uses to authenticate with the SIP server (SIP integrations only).
- **Repeat SIP Server Authentication Password** - Repeat the SIP Server Authentication Password entered above.
- **SIP Security Profile (IP Port)** - Select the SIP security profile that Unity Connection uses. Default setting = 5060.
- **Primary CUCM IPv4 Address or Host Name** - Enter the IP address (or host name) of the PIMG/TIMG unit that the port group connects to.
- **Redundant SIP Servers**
 - **Call Manager Server IP or Host Name** -

Unity Ports

Complete, at minimum, the mandatory fields (red border):

- **Publisher Server**

This field is auto populated based on the **Provisioning Target Unity** chosen under **Deployment Options**.

- **Publisher Port Count** -

- **Subscriber Server** -

- **Subscriber Port Count** -

CUCM Voicemail Pilot

Complete, at minimum, the mandatory fields (red border):

- **Pilot Number** - Enter a number to identify the voicemail pilot number.

- **Calling Search Space** - Enter an appropriate calling search space. A calling search space comprises a collection of partitions that are searched for numbers that are called from this pilot number.

This field is auto populated based on the **Voicemail Service Dial Plan Profile** chosen under **Deployment Options**.

- **Default Voice Mail Pilot for the System** - Select this check box if you want to replace the current default pilot number, and make this pilot number the default Voice Mail Pilot for the system.

CUCM Voicemail Profile

Complete the following fields as required:

- **Name** - Enter a name to identify the voicemail profile.

- **Description** - Enter the description of the profile. The description can include up to 50 characters in any language, but it cannot include double-quotes ("), percentage sign (%), ampersand (&), back-slash (\), angle brackets (<>), dollar sign (\$), single-quote('), open parenthesis ([), close parenthesis (]), slash (/), colon (:), semi-colon (;), equal sign (=), at sign (@), tilde (~), brackets ({ }), or apostrophe (').

- **Pilot** - Choose the appropriate voicemail pilot number that is defined in the Voice Mail Pilot Configuration or Use **Default**. This field is auto populated based on the **Pilot Number** entered under **CUCM Voicemail Pilot**.

- **Voice Mail Box Mask** - Specify the mask that is used to format the voice mail box number for auto-registered phones. When a call is forwarded to a voice-messaging system from a directory line on an auto-registered phone, CUCM applies this mask to the number that is configured in the Voice Mail Box field for that directory line.

- **Make this the default Voice Mail Profile for the System** - Select this check box to replace your current default profile, and make this the default profile name.

CUCM Route List

Complete the following fields as required:

- **Name** - Enter a name for this route list. The name can comprise up to 50 alphanumeric characters and can contain any combination of spaces, periods (.), hyphens (-), and underscore characters (_). Ensure that each route list name is unique to the route plan.

This field is auto populated based on the **Voicemail Service Dial Plan Profile** chosen under **Deployment Options**.

- **Run On All Active Unified CM Nodes** - Select this check box to enable the active route list to run on every node.
- **Call Manager Group** - Choose a CUCM group. The route list registers with the first CUCM in the group, which is its primary Cisco Unified CM.

This field is auto populated based on the **Voicemail Service Dial Plan Profile** chosen under **Deployment Options**.

CUCM Route Group

Complete the following fields as required:

- **Name** - Enter a name for this route group. The name can comprise up to 50 alphanumeric characters and can contain any combination of spaces, periods (.), hyphens (-), and underscore characters (_). Ensure that each route group name is unique to the route plan.

This field is auto populated based on the **Voicemail Service Dial Plan Profile** chosen under **Deployment Options**.

- **Distribution Algorithm** - Choose a distribution algorithm from the drop-down:
 - **Top Down** - If you choose this distribution algorithm, CUCM distributes a call to idle or available members starting from the first idle or available member of a route group to the last idle or available member.
 - **Circular** - If you choose this distribution algorithm, CUCM distributes a call to idle or available members starting from the (n+1)th member of a route group, where the nth member is the member to which CUCM most recently extended a call. If the nth member is the last member of a route group, CUCM distributes a call starting from the top of the route group.

Default = Circular.

CUCM to CUC Publisher SIP Trunk

Complete, at minimum, the mandatory fields (red border):

- **Device Name** - Enter a device name.
- **Trunk Device Pool** - This field is auto populated based on the **Voicemail Service Dial Plan Profile** chosen under **Deployment Options**.
- **Destination IP Address** - Choose from the drop-down list.

CUCM to CUC Subscriber SIP Trunk

This tab is only visible if the **Provision CUCM-Unity in Redundant Mode** check box on the **Base** tab is selected.

Complete, at minimum, the mandatory fields (red border):

- **Device Name** - Enter a unique device name.
- **Trunk Device Pool** - This field is auto populated based on the **Voicemail Service Dial Plan Profile** chosen under **Deployment Options**.
- **Destination IP Address** - Choose from the drop-down list.

19.2.3. Dial Plan Profile

This allows an advanced administrator to define all of the dial plan elements that make up the CUC integration.

Mandatory fields include; SIP Profile, SIP Trunk Security Profile, Device Pool, Route Group, Route List, SIP Trunk Inbound CSS, Call Manager Group and Voicemail Pilot CSS.

This form can be filled with static (exact) values if you want to deploy these same values over and over at Store level. This option is typically not used and is displayed for illustrative purposes only.

At the Provider hierarchy, macros are used to make the profile portable across several customers. For example, if you had two or three different versions of dial plans, then you would have two or three versions of this profile. The lower level administrators could then apply the profiles as required.

Note: You can only add a SIP integration once a Dial Plan Profile has been configured.

19.2.4. Remove Integrate Unity-CallManager

This tool (**Unity SIP Integration > Remove Integrate Unity-CallManager**) takes the complete selected SIP integration back out of the Cisco Unified Call Manager (CUCM) and Cisco Unity Connection (CUC).

From the **Integration Label** drop-down, choose the integration that you want to remove and click **Save**.

19.2.5. Unity Tenant Management

Unity Tenant Management assists in creating groups of objects in Unity Connection that provide a basic “tenant services” application. In short it allows you to create a tenant, which includes numerous interrelated database objects in Connection that work together to provide basic directory segmentation features to allow for isolated groups of users and handlers within your Connection server.

You can add or delete unity tenants.

Add a Unity Tenant

Note: The description, alias and SMTP Domain name must all be unique among tenants in your system.

1. Choose **Unity Tenant Management > Unity Tenant Add** to open the **Unity Tenant Add** form.
2. Complete, at minimum, the following mandatory fields:
 - **Target Unity Server** - .
 - **Unity Tenant Name (Alias)** - The alias is used as a prefix for all objects created in the tenant - used to make sure all objects in Connection are uniquely named.
 - **SMTP Domain** - a unique SMTP Domain name.
 - **Tenant Description** - .
3. Click **Save**.

Delete a Unity Tenant

Note: when deleting a tenant, ALL OBJECTS associated with that tenant are deleted as well. This means all users, call handlers, interviewers, schedules, COS etc. are deleted. There is NO UNDO for this. Make sure you really want to remove a tenant and all its objects before doing so.

1. Choose **Unity Tenant Management > Unity Tenant Delete** to open the **Unity Tenant Delete** form.
2. From the **Unity Tenant Name (Alias)** drop-down, choose the tenant to delete.
3. Click **Save** to remove the tenant.

19.2.6. Integration Log

This tool (**Unity SIP Integration > Integration Log**) will be populated with all the details relevant to the SIP Integration.

This includes when the integration was pushed, and other details so that the integration can be pushed back out again if required.

20. Subscriber Management

20.1. View and Manage Subscribers

20.1.1. View Subscribers

The Subscribers summary list view in the VOSS-4-UC Admin Portal displays:

- All subscribers from a given hierarchy and down (Reseller, Provider, Customer, or Site).
- Each subscriber's currently provisioned services, grouped by vendor.

Note: To access this page (via the default menus):

- Single vendor environment: In the Admin Portal, go to **Subscriber Management > Subscribers**
- Multi vendor environment: In the Admin Portal, go to **User Management > User Services > Multi Vendor Subscribers**

Click on a subscriber to access subscriber management functions for a selected subscriber.

The table describes columns in the Subscribers summary list:

Column Heading	Description
Role	Subscriber role, typically a self-service user role.
Sync Source	The source application of user data, for example: LOCAL indicates that the user has been manually created in VOSS-4-UC and has not been synced from LDAP or from Cisco Unified CM. CUCM indicates that the user exists on both VOSS-4-UC and Cisco Unified CM, and is not synced from LDAP. The user may have been created first on VOSS-4-UC (top-down) or created on Cisco Unified CM and synced into VOSS-4-UC (bottom-up). As for User ¹ .
User Type	End User, Admin - associated with the user role
Auth Method	As for User ² .
Entitlement Profile	The Entitlement Profile associated with the Subscriber.
Located At	Displays an abbreviated version of the hierarchy showing the lowest point in the hierarchy. The hierarchy type is shown in brackets. When you filter on this column, do not use text included inside the brackets in the filtering criteria. For example: "SiteName (Site)", where (Site)= the hierarchy node type, only search using the "SiteName" portion of the field.
PrimaryLine	The subscriber's primary extension number, as selected from the Pattern drop-down list when adding the subscriber.
ExtMobility	If a Subscriber is associated with more than one extension mobility profile on the Unified CM, and you sync with VOSS-4-UC, only the first extension mobility profile is displayed in this list view.
Single Number Reach	The remote destination number configured for the subscriber. Only if supported.
Voicemail	The Voicemail number allocated to the subscriber.
Conferencing	Enabled or disabled.
Webex Teams	Enabled or blank. Indicates whether or not the subscriber is enabled to use Webex Teams.
Contact Center	Enabled or blank. Indicates the contact center agent's Team and extension if the subscriber is an agent.
Phone	The phone associated to the subscriber. When you filter on this column, the results include all phones at the hierarchy level and below, regardless of the Phone column in which they reside.
Phone 2	The second phone associated to the subscriber.
Phone n	The number of phone columns displayed in the list view will be the same as the maximum number of associated to a particular subscriber. For example, if a subscriber is associated to 10 phones, the list view will show 10 Phone columns.
Device	IP Address or Host Name.

¹ **Sync Source:** see: [User Sync Source](#).

² **Auth Method:** see: [User Authentication Methods](#).

Multi Vendor Subscribers

The table describes columns relevant to multi vendor subscribers on the Subscribers summary list view in the Admin Portal:

Note: To access multi vendor subscribers in the Admin Portal, go to (default menus) **User Management > User Services > Multi Vendor Subscribers**

Column	Description
Voice	The subscriber's provisioned phones, listed by vendor.
Voicemail	The subscriber's provisioned voicemail services, listed by vendor.
Conferencing	The subscriber's conferencing services, listed by vendor, for example, Webex Teams, MS Teams, Pexip, Zoom.
Collaboration	The subscriber's messaging services, listed by vendor, for example, WebEx, MS Teams, Zoom.
Primary Line	The line extension used as the primary line (a pre-allocated administrator line, and associated E164 number).

Related Topics

- Multi Vendor Subscribers in the Core Feature Guide

20.1.2. Add Subscribers

Use this procedure as a high-level workflow to add one or more subscribers in VOSS-4-UC.

Note: If Enable CSS filtering is enabled at the customer dial plan, then for all calling search space fields in this procedure, the list of available calling search spaces includes only those that are marked as a Class of Service under **Dial Plan Management > Site > Class of Service** at the particular site. If another CSS is required, you can add custom CSSs in a CSS field if you know the exact syntax.

If Enable CSS filtering is not enabled, then the list of available calling search spaces includes all CSSs that are configured on VOSS-4-UC.¹

1. Log in as customer or site level administrator. If you are logged on as the customer administrator for a specific site you can see all the fields described in this procedure. If you are logged in as the site administrator, you can see a subset of the fields that are available on the interface.
2. On the **Subscribers** form, click **Add**.
3. Choose the site to which you want to add the subscriber (only required if logged in as a customer administrator).
4. Configure the details on the following tabs (see below).
5. When you are finished adding information for the subscriber, click **Save**.
6. Repeat steps 2 to 5 to add another subscriber.

¹ This only applies to the VOSS-4-UC *Provider* deployment.

User

On the **User** tab, complete fields to add a Unified CM user and a VOSS-4-UC user.

Consider the following when adding a user:

- Use only alphanumeric characters.
- A selected Entitlement Profile will be associated with the Subscriber.
- The options available in the **Service Profile** drop-down menu are those that were imported from Unified CM.
- If an existing phone is to be associated with a user, choose the device from the **Associated Devices** group.
- After an existing phone is associated to the user in the **Associated Devices** group **Device** drop-down menu, click **Save**. The subscriber is updated so that the **Phones** tab is populated with the information of the new phone associated with the user.
- If the added user is configured as an LDAP user, the **Password** and **Repeat Password** fields are hidden. The **Enable Mobility** check box is auto-selected if any of the following are included or added: a remote destination phone, mobile identity for a phone, or remote destination profile (RDP).

If subscriber self-provisioning has been set up so that subscribers can add their own smart devices (Company Phones *or* Personal Phones) and the **Enable Mobility** check box is *not* selected, then the setting will be enabled when subscribers add a smart device (Company or Personal Phone) on the Self-service interface.

- If the subscriber is entitled to use Webex Teams, you can add a standalone Webex Teams user by completing (at a minimum), the **Userid**, **Last Name** and **Email Address** fields and then going straight to [Add Subscribers](#) (Webex Teams tab).

Note:

To enable Extend and Connect in VOSS-4-UC, complete the following task:

1. Select the **Enable Mobility** check box.
 2. Add the following three groups of users:
 - a. Standard CCM End Users
 - b. Standard CTI Enabled
 - c. Standard CCM Admin User
- If a Customer is configured for EMCC, and if you want the subscriber to have access to the EMCC feature, select the **Enable EMCC** check box.
 - Choose a **BLF Presence Group** for the subscriber from the drop-down. The chosen group specifies the destinations that the subscriber can monitor and is configured in Cisco Unified Administration. BLF Presence Group authorization works with BLF Presence Groups to allow or block presence requests between groups. The Busy Lamp Field default is set according to the selected number and specifies the Standard Presence Group that is configured with installation.
 - Choose the Primary Extension for the subscriber by choosing from the **Pattern** drop-down list, which includes all lines available to the subscriber. The selected option is displayed in the Primary Line column for the subscriber on the **Subscribers** list view.
 - The Subscriber Language and Role can be set in the Site Defaults of the site hierarchy that the subscriber belongs to. If not set in the Site Defaults, hierarchy defaults apply.

Phones

On the **Phones** tab, click Phones **Add** and complete the required fields to add a new phone.

Consider the following when adding a phone:

- Modify the values for the following fields if desired: **Product Type**, **Device Protocol**, **Phone Button Template**, and **Device Security Profile**. The possible value options for these fields change depending on which associated fields are selected.

For example, when you enter the **Device Name** with the product prefix and the MAC address, 79XX-type phones have the device name 'SEP' prefixed, while ATA-type phones have 'ATA' prefixed to the MAC address. Fields are validated and tooltips are available to assist you to select the **Product** type.

You can override the default Phone Button Template value by selecting from the **Phone Button Template** drop-down, or by entering a custom value in the **Phone Button Template** field. The entered value will be applied on Unified CM if the Unified CM allows it for that phone type.

- Modify phone-specific settings such as **DND Option** drop-down menu, **Do Not Disturb** check box, and **Hot Line Device**. The phone settings that are available differ depending on the product (phone) type selected, the device protocol (for example SIP or SCCP), and the Field Display Policy (FDP) applied by the administrator. You can select a Mobile User ID Name from the drop-down list when a Dual-Mode Phone for Android or iPhones is selected. This associates the selected user to the Mobile Identity feature on this phone and must match the Userid added on the **User** tab.
- The advanced settings fields are updated automatically for the phone based on the phone type. The phone is automatically associated to the user and is then displayed as an associated device when you view the subscriber after adding it. If a phone that has been associated with a user is also associated with another user, the Owner User ID defaults to the first user.
- In the **Line** section, complete line assignments.
 - The **Pattern** drop-down list only shows lines with status 'Available' or 'Used'.
 - When you select a **Route Partition Name**, the available **Pattern** options are filtered according to the selected partition. However, you can add a custom pattern by typing it into the **Pattern** field.
 - The associated **Enduser** field identifies the user for Presence, but you can add a new User ID. VOSS-4-UC adds the user first and then adds the User ID.
- In the **Speeddial** section, add speed dial information. Available speed dials depend on the Phone Button Template.
- In the **Busy Lamp Field** section, specify Busy Lamp Field values. Fields include: **Position**, **Label**, **Blf Destination**, and so on.
- In the **Blf Directed Call Park** section, specify Busy Lamp Field Directed Call Park values. Values depend on a valid Directed Call Park on Unified CM.
- In the **Add On Module** section, specify Add On Modules if desired. The specified Add On Module **Model** selected must be supported by the specific Phone Type. **Load Name** should be left blank unless the default value should be overridden.
- In the **Service** section, add services that are valid IP services for Phones. To add a service to the device, a number must be added as the Uri Button index. If you do not add a number, only the service is added.
- Use the **Mobile Identity** section to configure mobile identity details when you select a Dual-Mode Phone. Fields include: **Name**, **Dual-Mode Device** (automatically populated from the **Device Name** field), and **Mobility Profile** (chosen from a drop-down list). The **Destination Number** field is a mandatory field and determines the destination number that is dialed when a call is made to the dual-mode phone.

- Use the **Remote Destination** section to configure your remote destinations when a Dual Mode Phone or Cisco Spark Remote Device is selected as the **Product**. Remote destinations represent the mobile (or other) phones that are able to accept transfer from the desktop phone and can be used to initiate calls. Set the Pattern for the Line Association to the Route Partition name. If you enter more than one Pattern and the new Pattern is not on the system, enter the Route Partition Name manually. The **Owner User Id** and **Dual Mode Device Name** fields are auto populated.

Note: When a CTI Remote Device is selected as the **Product**, a **CTI Remote Destination** section replaces **Remote Destination**. This allows you to configure your remote destinations specifically for a CTI Remote Device. The **Owner User Id** and **CTI Remote Device** fields are auto populated.

- Use the **Vendor Config** section of the tab to view and edit the configuration settings for each device. The available configuration settings depend on each Product type selected. Modify settings as required.

Note that:

1. The administrator password from the `AdminLoginDetails` in Unified CM is not stored in VOSS-4-UC. Data in VOSS-4UC is obtained from Unified CM.
2. VOSS-4-UC cannot disable the `Override Enterprise/Common Phone Profile Settings` setting once this check box has been enabled in the Unified CM GUI.

This setting needs to be disabled on Unified CM if the user wishes to disable it.

Extension Mobility

On the **Extension Mobility** tab, complete fields to configure extension mobility for the subscriber.

Consider the following:

- Only one EM Profile can be added for extension mobility in VOSS-4-UC. If a subscriber is associated with more than one EM profile on the Unified CM, and you sync with VOSS-4-UC, both will be displayed:
 - on the subscriber's EM tab (this tab)
 - on the **Extension Mobility** list view (see [Standalone Extension Mobility](#)).
- As with the **Phones** tab, **Product**, **Protocol** and **Phone Button Template** fields change, depending on the selection of an associated field.

The considerations regarding the fields on this tab are the same as on the **Phones** tab with the exception of remote destination information, which is not available on extension mobility (see *Consider the following when adding a phone* under **Phones** above).

- Ensure that you associate the extension mobility profile and target phone for login with the extension mobility service.
- If the Enable Extension Mobility Cross Cluster (EMCC) feature is enabled on the **User** tab, you must choose a CSS for this device from the **Extension Mobility Cross Cluster CSS** drop-down. The selected CSS is used as the device CSS that gets assigned to the phone when the user logs in to this remote phone. New CSS's or existing CSS's can be added or modified in Unified CM. Refer to the Cisco Unified Communications Manager Features and Services Guide for more details if required.

See also [Standalone Extension Mobility](#) to add or edit an extension mobility profile, and associate it to one or more subscriber.

Single Number Reach

On the **Single Number Reach** tab, note that you cannot add more than one Remote Destination Profile for Single Number Reach. However, you can add more than one Remote Destination Rdp.

Note:

To enable Extend and Connect in VOSS-4-UC, make sure to complete the following task:

1. Select the **Enable Extend and Connect** check box.
2. Select the CTI remote device that you created from the **CTI Remote Device Name** drop-down list.

Voicemail

On the **Voicemail** tab, configure voice mail service for the subscriber if a valid Cisco Unity Connection server is available.

Consider the following when configuring voice mail:

- You can leave the PIN and Password empty, in which case the default credential policy on the Cisco Unity Connection is used.
- If the user on Cisco Unity Connection is LDAP integrated, the **Password** field is visible but should be ignored.
- The **Voicemail Line** drop-down list only shows lines with status 'Available' or 'Used' that are not already configured for Voicemail. The Cisco Unity Connection server uses this line as a caller ID, so you should set it to the subscriber's default line.
- When Voicemail is added for a Subscriber, all **Call Forward To Voicemail** check boxes, except **Call Forward All**, will be enabled on the chosen Line, and the Voicemail Profile setting will be set based on the Site Default Doc setting "Default CUCM Line Voicemail Profile" (**Site Management > Defaults > Line Defaults**).

WebEx

On the **WebEx** tab, add details if a valid server is available. The mandatory fields on this tab are populated with the values entered on the **User** tab.

Note: Any updates on the **User** tab do not update these values; values are populated only during the Add workflow.

Webex Teams

On the **Webex Teams** tab, click Webex Teams User +, and select the check boxes to select the desired Enabled Services and Roles for the subscriber:

Consider the following:

- a. Webex Teams is only available if a Webex Teams Service has been created at the required customer level (see [Create Webex Teams Service](#)), and if the **Webex Teams** check box has been selected in the Entitlement Profile associated to the Subscriber.
- b. The Webex Teams User fields, **Login Enabled** and **Invite Pending** check boxes are read-only and can not be edited.

- c. “Enabled” is displayed in the Webex Teams column on the **Subscribers** screen next to the subscriber once successfully added as a Webex Teams user.
- d. The Subscriber e-mail address is required to enable Webex Teams for the Subscriber.

Pexip Conference

On the **Pexip Conference** tab, click **Pexip Conference +**, and enter the fields required to configure the Pexip service for the subscriber.

Consider the following:

- The **Pexip Conference** tab is only available if a Pexip Conference service has been configured at the required hierarchy (via the Quick Add Subscriber Group).
- Entitlement Profile: the **Conferencing** check box has been selected and associated to the Subscriber.
- “Enabled” is displayed in the **Conferencing** column on the **Subscribers** list view next to the subscriber once successfully added as a Conferencing user.

Contact Center Subscriber

Contact Center Management

The Subscriber feature supports adding, removing or updating CCX agent capabilities to a Subscriber.

The **Contact Center** tab is only available if:

- CCX device has been added and is available to the hierarchy.
- Contact Center Service has been configured and is available to the hierarchy.
- Entitlement Profile: the **Contact Center** check box has been selected and associated to the Subscriber.

Consider the following for the Agent:

- Since CCX restricts the use of special characters, these are restricted in the **Alias**.
- **Team**, **Resource Group** and **Skill** names need to be set up or synced from the CCX device before they can be assigned.
- **Automatic Available** is enabled by default.
- An IPCC extension is automatically managed for the Unified CM user associated with the Contact Center Agent.
- It is possible to change the the agent’s **Controlled Device**. The device in question must already be associated with the Subscriber before attempting to set or change it.

20.1.3. Modify Subscribers

This procedure modifies settings for one or more subscribers.

Perform these steps:

1. Log in as a customer or site level administrator. If you are logged on as the customer administrator for a specific site you can see all the fields described in this procedure. If you are logged in as the site administrator, you can see a subset of the fields that are available on the interface.
2. Choose a site from the hierarchy breadcrumb.

3. Open the Subscriber summary list page:
 - In a single vendor environment, go to (default menus) **Subscriber Management > Subscribers**.
 - In a multi vendor environment, go to (default menus), **User Management > User Services > Multi Vendor Subscribers**
4. Click on a subscriber you wish to edit to open the editing page.
5. Modify subscriber information as required, using the workflow described in [Add Subscribers](#).

Note:

- You can use the pop up form that is available when modifying the Subscriber on the Phones tab to add more than one phone. Also, instances of one-to-many or zero-to-many items can be deleted, such as a Phone.
 - If Extension Mobility is associated with more than one subscriber, it will not be removed when removing it from one subscriber.
-

The line settings of a phone can be modified directly from the Subscriber form. When expanding the Line group of a Phone or Extension Mobility Profile, the Link to Line hyperlink on each Line form directs the user to the specific Line relation details. The details can then be modified and saved, after which the user will be returned to the base tab of the Subscriber form. The user can also navigate back to the base tab of the Subscriber by using the back button.

When a user's menu layout has more than one entry for `relation/LineRelation` and associated Field Display Policy, then the form opened by the Link to Line hyperlink will apply the first one (searching from top to bottom) found in the user's menu layout, if one is available.

6. Click **Save**.

Note: Filtering on the following columns on the Subscribers list view is described in more detail below:

- Located At - Displays an abbreviated version of the hierarchy showing the lowest point in the hierarchy. The hierarchy type is shown in brackets. When you filter on this column, do not use text included inside the brackets in the filtering criteria. For example: "SiteName (Site)", where (Site) = the hierarchy node type, only search using the "SiteName" portion of the field.
 - Device - You can filter on IP Address or Host Name.
 - Phone - When you filter on this column, the results include all phones at the hierarchy level and below, regardless of the Phone column in which they reside.
-

Related Topics

- [Multi Vendor Subscribers in the Core Feature Guide](#)

20.1.4. Delete Subscribers

This procedure deletes and unprovisions a subscriber.

Perform these steps:

1. Log in to the VOSS-4-UC Admin GUI as a customer or site level administrator.
 - If you're logged in as customer administrator for a specific site, all tabs and fields described in this procedure are visible to you.
 - If you're logged in as site administrator, only a subset of the tabs and fields described in this procedure are visible.
2. Choose a site from the hierarchy breadcrumb.
3. Choose **Subscriber Management > Subscribers**.
4. Select the checkbox for each subscriber you wish to remove; then, click **Delete**.
5. Click **Yes** to confirm.

The deleted subscriber is removed from the list. All elements associated with the subscriber are removed, except lines.

Note: For scenarios that include an LDAP-integrated Cisco Unified Communications Manager, users are deleted from the LDAP directory and not from the VOSS-4-UC system. Set up a data sync to synchronize the removal of the user.

20.1.5. Move Subscriber

This feature allows a customer administrator (or higher) to move a subscriber:

- from provider level to a site (must be logged in as provider administrator)
- from customer level to a site
- from one site to a different site under the same customer
- from one site to another site on a different Unified CM cluster and CUCxn cluster

This is done using the **Move Subscriber** form (default menu **Subscriber Management > Move Subscriber**) as follows:

Subscriber Configuration

- When moving a subscriber, the subscriber, phones, device profiles, SNR, voicemail, and VOSS-4-UC data are processed in the move.
- When moving a subscriber to a different Unified CM cluster, you need to select a **New CUC User Template**.
- The subscriber will be updated with a new primary extension where appropriate. The services associated to the selected subscriber that will be moved with the subscriber are shown on the **Existing Services** card (see below).
- The subscriber role at the 'move to' hierarchy is selectable via a drop-down.

- A device pool at the hierarchy is mandatory. You can select either the default device pool at the ‘move to’ hierarchy or choose a different device pool from a drop-down list.
- An optional user template `MoveUpdateUserCustom_CFT` can be selected to make custom subscriber updates. You can clone and customize this template if required. The available user templates are listed on the **Configuration Templates** form (default menu **Customizations > Configuration Templates**).

Desk Phone Configuration

- Desk phones can either remain at the old site or move with the subscriber. Existing softphone devices, such as Jabber or Dual Mode devices will always be moved, but can be configured by the Jabber/Dual Mode configuration templates (see *Jabber/Dual-Mode Device Configuration*).
- The default operation is to move all phones, i.e. **Move Desk Phones** check box = **Selected**. If the desk phones are not moved, they remain at the original site and are disassociated from the subscriber.
- A new phone can be created at the ‘move to’ hierarchy by selecting the **Create New Phone** check box.
 - When also selecting **Use Existing Phone Configuration**, the existing phone configuration can be used as a template, and the **Phone Configuration Source**, **Desk Phone Profile** and **Phone Name** can be selected from drop-down lists.
 - * The **Phone Configuration Source** drop-down displays a list of the subscriber’s existing phones. If an existing phone is selected, the new phone will be created using the configuration of the existing phone.
 - * The **Desk Phone Profile**, which defines the phone type (and associated configurations), and the **Phone Name** available in the drop-downs are those displayed on the **Phone Configuration Mapping** form (default menu **Customizations > Phone Configuration Mapping**).

Default phone configuration mappings are available per hierarchy and are used at the selected hierarchy and below.

See “Configuration Mapping Files” in the Core Feature Guide for more details.
- For new phones, when *not* selecting **Use Existing Phone Configuration**, the user should choose:
 - * The **Desk Phone Profile**, which defines the phone type (and associated configurations), and the **Phone Name** available in the drop-downs are those displayed on the **Phone Configuration Mapping** form (default menu **Customizations > Phone Configuration Mapping**).
 - * The **Desk Phone Feature Template** is available for the selection of a template from the first Phone Mapping Configuration found up the hierarchy tree.

The Move Subscriber process applies the newly created phone with the desk phone profile and then on top of it the details from the chosen Feature Template.

Jabber/Dual-Mode Device Configuration

- Jabber and Dual Mode devices are automatically moved with the Subscriber.
- The device configuration is derived from the device profile selected in the associated **Profile** drop-down, i.e. Android, CSF, Tablet, iPhone, Carrier Integrated Mobile and CTI Remote Device. The default device profiles are found on the **Phone Mapping [Default]** form (default menu **Customizations > Phone Configuration Mapping**).
- You can clone and save a profile if required, and customize the relevant settings, e.g. **Basic Phone CFT** in order to apply different settings to the device.

See “Configuration Mapping Files” in the Core Feature Guide for more details.

Line Configuration

Creating Lines

When moving to another Unified CM cluster, new lines must be defined.

When a new line is defined, a **Line Template** can be selected for the new line. One line template may apply to all lines.

The CSS's for the new lines can be defined, and a configuration template `MoveUpdateLineCustom_CFT` is available to make custom line updates.

The system performs a check to ensure that the first line across devices is common. All new lines created (or existing lines moved) in the move, will be assigned to SNR. For example, if a Subscriber with 3 lines and a Phone, SoftPhone, DeviceProfile, SNR is moved, all these services will be associated with the 3 lines. The only exception to this is for Voicemail, where the first line is always selected as the Voicemail line.

Moving Lines

Important:

- **Moving of lines functionality is neither exposed nor supported by VOSS-4-UC.** If you want to assume the risk of moving lines, contact VOSS support to expose the move line functionality.
 - Lines can only be moved if your system is using a type 4 dial plan, and only *if the move is on the same cluster*. Make sure that the customer dial plan supports moving of lines between sites before attempting to move the line.
 - SLC based dial plans (types 1, 2 and 3) do not support moving of lines between sites.
-

If the move is between sites hosted on the same Unified CM cluster, the subscriber data is moved to the new hierarchy and updated as above. It is assumed that the CUCxn (if used) will remain.

If the move is between different Unified CM clusters, the specific move data as defined above is re-provisioned on the new cluster and deleted on the original cluster, except for the Unified CM subscriber. When the Unified CM subscriber is local, the old subscriber is removed.

In the case of an LDAP user, the VOSS-4-UC subscriber is purged. The user is removed from the `device/cucm/User` model of the source Unified CM in VOSS-4-UC. The home cluster flag is maintained such that it is only set to true on the Unified CM cluster hosting the subscriber, even if the subscriber exists on other Unified CM clusters.

When moving between clusters, the CUCxn server can be retained. In this case, the model instances are moved. In the case that the CUCxn server changes, a new CUCxn subscriber is created against a chosen subscriber template. This will not copy custom settings for the CUCxn subscriber or any recorded prompts and messages.

Caveats

- The first line on all devices must be common prior to the move. Replacing lines creates the same line layout on all devices.
- When moving cross cluster, the Unified CM cluster is changed. The CUCxn cluster may be retained or changed, based on the new site NDL. If the CUCxn cluster is changed, only basic voicemail is created - user customized configuration, as well as prompts and messages are not moved to the new CUCxn cluster.
- CUCxn cluster moves are only supported where the Unified CM cluster changes.

Existing Services

The following existing services associated to a subscriber will also be moved:

- phones (and associated lines)
- devices
- device profiles
- single number reach
- voicemail
- webex
- webex teams
- contact center

20.1.6. Add Device to User

Use this utility to easily associate an existing phone or device profile with an existing user.

1. Choose a **User Name**.
2. Choose the association type:
 - *For a device*, choose **Phone** as the **New Device Type** and choose the phone as the **New Device Name**.or
 - *For a device profile*, choose **Device Profile** as the **New Device Type** and choose the device profile as the **New Device Name**.
2. Click **Save**.

The device is added to the user as a controlled device and the device itself is updated with the owner ID and line owner as applicable.

Note: You cannot associate a device to a user if it is already associated.

20.1.7. Multi Vendor Subscribers

The multi vendor subscribers feature allows you to provision and manage services from one or more vendors on the VOSS-4-UC platform. For example, to use both Microsoft meeting and collaboration tools and Cisco tools.

VOSS-4-UC supports provisioning for two categories of subscriber, representing either a single or multi vendor deployment:

Single vendor subscriber	Subscribers using services from a single vendor, for example, either all Cisco services, or all Microsoft services.
Multi vendor subscriber	Subscribers using services from two or more vendors.

You can access a multi vendor subscribers service summary list view from:

Interface	Description
Admin GUI	Go to (default menu): User Management > User Services > Multi Vendor Subscribers
Business Admin Portal	View subscribers from (default menu): <ul style="list-style-type: none"> • Subscribers menu • Home page <ul style="list-style-type: none"> – Subscribers service card – Quick Actions link (View Subscribers) <hr/> <p>Important: Multi vendor subscriber must be enabled (via the Subscribers tab in the Business Admin Portal profile).</p> <hr/>

Related Topics

- **Configuration**
 - Configure Multi Vendor Subscribers in the Core Feature Guide
 - Global Settings
 - Role-based Access for Multi Vendor Subscriber in the Core Feature Guide
- **Field Display Policies**
 - Multi Vendor Subscriber Field Display Policy in the Core Feature Guide
- **Profiles**
 - Business Admin Portal Profiles in the Core Feature Guide
 - Entitlement in the Core Feature Guide
- **Subscribers and Users**
 - View Subscribers in the Business Admin Portal Guide
 - Users and Subscribers in the Core Feature Guide

- Subscribers in the Business Admin Portal Guide
- Enable User to Host Conference Now in the Business Admin Portal Guide
- **Interface**
 - View Subscribers in the Core Feature Guide

20.1.8. Configure Multi Vendor Subscribers

This procedure enables multi vendor subscriber, and involves the following tasks:

- Configure Global Settings
- Configure the multi vendor field display policy (`MultiVendorFDP`)
- Enable multi vendor in the Business Admin Portal profile.
- Assign the Business Admin Portal profile configured for multi vendor to relevant user roles.
- Configure entitlement profiles.
- Verify that you have appropriate servers installed and configured.

Perform these steps:

1. Log in to the Admin Portal.
2. Select the hierarchy.

Note: The global setting to enable multi-vendor is typically defined at the customer hierarchy, although it may be enabled/disabled at any level.

3. Configure the Global Settings for multi vendor:
 - Go to (default menu) **Customizations > Global Settings**.
 - On the **Enabled Services** tab, enable services, as required.
 - Save your changes.

Note: For new installs of VOSS-4-UC, once a CUCM is imported and a customer hierarchy and some sites have been created, CUCM services are enabled by default at system level; other services must be enabled, as required. The Global Settings are retained on upgrade.

4. Configure the multi vendor subscriber field display policy:
 - Go to (default menu) **Customizations > Field Display Policies**.
 - Click on the default multi vendor field display policy (`MultiVendorFDP`) to open its editing screen.
 - Click **Action > Clone** to create a copy of the default FDP.

Note: It is recommended to clone default templates rather than overwriting default settings. The multi vendor FDP is associated with the model relation/`MultiVendorSubscriber`.

- Edit the cloned multi vendor FDP:
 - To add a new card, click the Plus icon (+); then, configure the card.

- To delete a card, click the Minus icon (-).
- To edit a card, click the down-arrow on the card to display editing options:
 - * Click **Move Up** or **Move Down** to rearrange the position of cards.

Note: It is recommended that you leave the **User Details** card and the **Quick Actions** in their default positions at the top of the dashboard.

- * Change card titles.
- * Choose whether to display the card as a fieldset with columns.
- * Change fields in the Quick Actions.
- * Add fields to a card by selecting and moving fields from **Available** to **Selected**.
- * Remove fields by selecting and moving fields from **Selected** to **Available**.

Important: Select valid fields for the model (allowed services). Only valid fields will display on the service cards once you apply the FDP.

Check the field naming convention when choosing fields, for example:

- * Field names prefixed `account_information` are valid for the **User Details** card.
- * Field names prefixed `cisco_webex` are valid for **Webex**.
- * Multi vendor field name formats, such as `mvs_user_qa`, where:
 - `mvs` is the alias for *multi vendor subscriber**
 - `_qa` is *Quick Action*

If a service or action is disallowed in the global settings, entitlement profile, or the Business Admin Portal profile, or if required servers are not installed for the service, the system verification check does not allow display of the service or action on the Subscriber management dashboard (defined via the FDP), and the subscriber cannot be provisioned with this service.

- Save your changes.

5. Enable multi vendor in the Business Admin Portal profile:

Note: Required only if you're using the Business Admin Portal. Only admin users with an access profile that allows updates to the Business Admin Portal profiles may perform this step.

- In the Admin Portal, go to (default menu) **Customizations > Business Admin Portal Profiles**.
- Click on the relevant profile to open the editing screen. Update an existing cloned profile, or clone a profile to create a new custom profile.
- On the **Subscribers** tab, select **Enable Multi-Vendor**. The multi vendor field display policy is applied.
- Save your changes.

6. Assign the multi vendor-enabled Business Admin Portal profile to relevant user roles:

Note: Required only if your organization uses the Business Admin Portal.

- Go to (default menu) **Roles > Role Management**.
 - Click on the user role to open its editing screen.
 - In **Custom Interfaces**, from the **Interface Type** field, select `InterfaceBusinessAdminPortal`, and in the **Name** field, select profile name.
 - Save your changes.
7. Optional. Configure entitlement profiles for multi-vendor:
- Go to (default menu) **Entitlement > Profiles**.
 - Click on the relevant entitlement profile to open its editing screen.
 - Select the services you wish to enable for the profile.
 - Save your changes.
8. Verify that you have appropriate servers installed and configured:
- Go to (default menu) **Apps Management**, and select the relevant server, for example, for CUCM, select **CUCM > Servers** to view and manage the servers.
 - Repeat this step to verify the presence of all required servers.
9. Verify that you can view multi vendor subscribers in the Business Admin Portal (if applicable):
- In the Business Admin Portal, log out and log in (or refresh the page) to apply the new profile.
 - Click the **Subscribers** menu to view multi vendor subscribers.
 - The Subscribers list view **Services** column presents service icons and tooltips indicating the vendor.
 - The Subscriber dashboard displays service cards selected for the multi vendor field display policy.

Note: Service cards are loaded dynamically based on the configuration defined via the FDP. You can edit the FDP to change the content and display of the service cards.

Related Topics

- Multi-vendor Subscribers in the Core Feature Guide
- Global Settings
- Business Admin Portal Profiles in the Core Feature Guide

20.1.9. Role-based Access for Multi Vendor Subscribers

Role access profiles define the permissions that allow subscribers to access services and resources.

When provisioning multi vendor services, the system runs validation checks for multi vendor subscriber against each of four tiers in the system, at the relevant hierarchy. The service must be enabled at each tier before the system allows access to the service:

Validation	Interface	Description
1. Global Settings	Admin Portal Navigation (default menu): Customization > Global Settings (Enabled tab)	Enable the service type at the user's hierarchy level, or above.
2. Entitlement profile	Admin Portal Navigation (default menu): Entitlement > Profiles	Enable the service in the entitlement profile assigned to the subscriber, at the relevant site. Services can only be provisioned to a subscriber if their entitlement profile allows those services. The entitlement profile lists the provisioning vendor (per service).
3. Device management	Admin Portal Navigation (default menu): Apps Management > Servers	The relevant servers must be installed and configured before a service can be provisioned. For example, a CUCM server must be installed before CUCM services, such as phones, can be provisioned. If you have two or more vendors provisioning devices, VOSS-4-UC verifies that the required servers and devices are configured and available for your system.
4. Field display policy	Admin Portal Configure multi vendor FDP: Navigation (default menu) Customizations > Field Display Policies Enable multi vendor in the Business Admin Portal profile: Navigation (default menu) Customizations > Business Admin Portal Profiles	Clone and edit the default multi vendor subscriber field display policy (default name: MultiVendorFDP). Enable multi vendor in the Business Admin Portal profile (Base/Details tab, and Subscribers tab), and select the multi vendor FDP to define the services the subscriber can view and manage in the Business Admin-Portal lists, dashboards, and service management screens.

Multi Vendor Subscriber Access Validation Example

In this example scenario, a customer admin (or higher) provides a user with site admin role with the ability to view and edit subscriber voice services. The customer admin wants to control the actions the site admin may perform.

- Only the Cisco Voice service is enabled for this site admin
- The site admin may edit subscriber services
- The site admin may not add or delete subscriber services

The table describes the configuration steps to set up this scenario, and the result:

<p>Configuration steps</p>	<ol style="list-style-type: none"> 1. Ensure the system has multi vendor subscriber functionality installed. 2. At customer level or above, in the Global Settings (Enabled Services tab), enable CUCM only. 3. In the Entitlement Profile for this user, enable CUCM Voice Service only. 4. At site level, select Multi Vendor Enabled for the Business Admin Portal access profile for subscribers, and choose the multi vendor subscriber field display policy (default name: <code>MultiVendorFDP</code>) 5. At site level, configure the multi vendor subscriber field display policy for the profile: <ul style="list-style-type: none"> • Remove all service cards except Voice. • Remove Add/Delete fields from the Quick Actions panel.
<p>Result</p>	<p>The site admin logs in to a multi vendor subscriber enabled system, at the relevant site hierarchy, and:</p> <ul style="list-style-type: none"> • Can view subscriber voice services in the Business Admin Portal. • Is unable to add or delete services. Only Edit is available in the Quick Actions

Related Topics

- Role-Based Access in the Core Feature Guide
- Multi Vendor Subscribers in the Core Feature Guide
- Global Settings in the Core Feature Guide
- Multi Vendor Subscriber Field Display Policy in the Core Feature Guide
- Business Admin Portal Profiles in the Core Feature Guide
- Entitlement in the Core Feature Guide

20.1.10. Multi Vendor Subscriber Field Display Policy

The multi vendor subscribers field display policy (default: `MultiVendorFDP`) defines the look and feel of the **Subscriber** dashboard in the Business Admin Portal, and shows/hides services and MACD actions for multi vendor subscribers.

This field display policy allows you to:

- Change card titles
- Define the content displayed on the cards, including display fields in User Details, and actions in Quick Actions
- Re-order the card layout on the dashboard

The multi vendor FDP must be associated with a Business Admin Portal profile to allow users to view and work with multi vendor subscribers in the Business Admin Portal.

When enabling multi vendor in a Business Admin Portal profile (**Subscribers** tab), the profile uses the multi vendor FDP. The Business Admin Portal profile must be assigned to a user role to allow users with this role to view and manage multi vendor subscribers.

Related Topics

- Multi Vendor Subscribers in the Core Feature Guide
- Configure Multi Vendor Subscribers in the Core Feature Guide
- Add or Edit a Field Display Policy in the Core Feature Guide

20.2. Quick Add Subscriber

20.2.1. Quick Add Subscriber: Overview

Quick Add Subscriber (QAS) provides a single page where you can:

- Add users to Unified Communications Manager
- Provision a voice service for Unified Communications Manager users. See *Provision the Voice Service* for more details.
- Add users to voicemail and WebEx accounts
- Provision users with services, such as Extension Mobility, Voicemail, Single Number Reach, and conferencing and collaboration services.
- Add lines for Unified Communications Manager users
- Associate a Device Pool directly from the interface to a subscriber's newly associated devices or services other than the Device Pool provided in the Site Defaults Doc (SDD) or reference Configuration Template (CFT) in the Quick Add Group (QAG). See *Quick Add Subscriber Device Pool* for more details.
- Associate Calling Search Space (CSS) values to a subscriber's newly associated lines, devices or services other than the CSS's provided in the Site Defaults Doc (SDD) or reference Configuration Template (CFT) in the Quick Add Group (QAG), by selecting a Class of Service (CoS) directly from the interface. See *Quick Add Subscriber Class of Service* for more details.

QAS supports many user types, including:

- LDAP users
- Unified Communications Manager integrated users
- LDAP-integrated users on Unified Communications Manager
- Manually created users

If the Default Self-service Language is set on the SDD, users will be assigned the corresponding Self-service language.

A Quick Add Group (QAG) is a collection of templates that configure the subscriber features, and is mandatory when adding a QAS.

Note:

- To add subscribers using QAS, a default user template called "voicemailusertemplate" must exist on the Unified CM. This default can be edited by editing the default CUC User Template value in the SDD.
- If Webex Teams is enabled, select the Quick Add Group that configures the required Jabber devices.

For self-provisioned phones to show as being associated with a subscriber, perform a Cisco Unified Communications Manager Data Sync after setting up a self-provisioned phone.

Any modifications of the added subscriber and associated services are done from the respective service menu items.

The Quick Add Subscriber form allows you to enable user services, such as voicemail, extension mobility, single number reach, and conferencing (meetings) and collaboration (messaging) services (such as Webex Teams). See also, [Webex Teams Quick Add](#). The QAS page only displays services that are included in the entitlement profile you select on this page. For example, if the entitlement profile does not include voice services, the checkboxes for Voice, Jabber, and Self Service ID won't appear on the page. The selected entitlement profile also filters options available in the **Phone Type** drop-down (showing only devices enabled in the entitlement profile).

For the Voicemail service:

- Controls will also not be available if the site's SDD has no default value on the CUC Defaults tab for the Default CUC Subscriber Template. This default value (voicemailusertemplate) should already exist on the Unified CM and is automatically populated on an HCS system when a VoiceMail Pilot is created.
- A Cisco Unity Connection device must also be configured at the related NDL (Network Device List) at site level.
- If the selected QAG specifies any CFT entries for UserPin or UserPassword, these will be applied. Otherwise, the values from the User Template defined on Cisco Unity Connection apply. For default CFTs, see: [Quick Add Subscriber Groups Default Model](#).

While the Admin Portal hides controls if services are not available, API and Bulk Load operations have Provisioning Workflow checks for the presence of the Default CUC User Template in the SDD and a configured WebEx Server in the NDL before the selected services can be added.

If no Unified CM has been configured at the hierarchy that the Subscriber belongs to, then Quick Add Subscriber bulk load transactions and API calls will show a warning message: No Call Manager has been configured.

Webex Teams Quick Add

Selecting the **Webex Teams** checkbox on the QAS page displays the **Webex Teams User Template** drop-down, where you can select a **Webex Teams User Template** to apply to the user.

- Choosing a template from the drop-down overrides the default user template referenced in the Quick Add User Group associated with the user.
- If you don't select a **Webex Teams User Template** from the drop-down, the **Webex Teams User Template** referenced in the associated Quick Add User Group is applied.

If you want customized values, clone the **Webex Teams User Template (Customizations > Configuration Templates)** and edit as required. The Webex teams User Template for CUCM Calling provides for a **Settings** group of controls for the specification of Calling Behaviour and provisioning of Jabber devices if relevant to the calling behaviour.

20.2.2. Quick Add Subscriber Device Pool

A Device Pool contains system, device, and location-related information, and is mandatory when adding a Subscriber using Quick Add Subscriber. A Device Pool can be referenced by:

- Site Defaults Doc (SDD)
- Reference Configuration Template (CFT) referenced in the Quick Add Subscriber Group (QAG)
- Admin Portal (if exposed)

Site Defaults Doc

The Device Pool referenced in the SDD makes sure that a Subscriber's devices are always associated to a Device Pool. If there is no Device Pool referenced in either the QAG or Admin Portal drop-down (see below) the value defaults to the SDD.

Quick Add Subscriber Group (QAG)

The Device Pool referenced by a Configuration Template (CFT) in the QAG takes precedence over the Device Pool referenced in either the SDD or the Admin Portal drop-down (if exposed). See [Quick Add Subscriber Group](#) for details.

Admin Portal

An Administrator can expose a Device Pool drop-down on the QAS page on the Admin Portal by editing or cloning the Field Display Policy. See [Expose Device Pools and Class of Service in Quick Add Subscriber](#). The Device Pool drop-down allows an Administrator to overwrite the value in the SDD by selecting a custom Device Pool from the drop-down list. The options available in the list are the site-level Device Pools if they are available, otherwise it displays all Device Pools available at Customer level (NDLR aware).

Note: When exposing the Device Pool drop-down, the Administrator **must** remove the value in the Device Pool field of the CFT referenced in the QAG, that is, the field must be blank. This is done to make sure that the value in the CFT does not overwrite the custom value in the drop-down.

The CFTs and their target models for which the Device Pool name can be made blank to allow the Portal to drive the Device Pool selection include:

- Phone templates (device/cucm/Phone)
 - Jabber device templates (device/cucm/Phone)
 - Remote Destination Profile templates (device/cucm/RemoteDestinationProfile)
-

20.2.3. Quick Add Subscriber Class of Service

A Class of Service (CoS) allows the user to specify a Calling Search Space (CSS) for devices and lines, respectively. A CSS, in turn, is mandatory for lines and devices when adding a Subscriber using Quick Add Subscriber. A Calling Search Space can be referenced by:

- Site Defaults Doc (SDD)
- Reference Configuration Template (CFT) referenced in the Quick Add Subscriber Group (QAG)
- Admin Portal via the Class of Service field (if exposed)

Site Defaults Doc

The Calling Search Space values referenced in the SDD ensure that a Subscriber's lines and devices always have a Calling Search Space associated to it. If there are no Calling Search Space values referenced in either the QAG or via the Class of Service field in the Admin Portal drop-down (see below) the value defaults to the SDD.

Quick Add Subscriber Group (QAG)

The Calling Search Space values referenced by a Configuration Template (CFT) in the QAG take precedence over the Calling Search Space values referenced in either the SDD or the Class of Service via the Admin Portal drop-down (if exposed). See [Quick Add Subscriber Group](#) for details.

Admin Portal

An Administrator can expose a Class of Service drop-down on the QAS page on the Admin Portal by editing or cloning the Field Display Policy. See [Expose Device Pools and Class of Service in Quick Add Subscriber](#). The Class of Service drop-down allows an Administrator to overwrite the Calling Search Space values in the SDD by selecting a custom Class of Service from the drop-down list. The Class of Service, in turn, contains a custom Calling Search Space for Lines and Devices respectively. The options available in the list are the customer level Class of Service instances, as created by the relevant administrator.

Note: When exposing the Class of Service drop-down, the Administrator **must** remove the values in the Calling Search Space fields of the CFT's referenced in the QAG, that is, the field must be blank. This is done to make sure that the value in the CFT does not overwrite the custom Calling Search Space value as defined in the selected Class of Service.

The CFTs and their target models for which the Calling Search Space name can be made blank to allow the Portal to drive the Calling Search Space values include:

- Line templates (device/cucm/Line)
 - Phone templates (device/cucm/Phone)
 - Jabber device templates (device/cucm/Phone)
 - Remote Destination Profile templates (device/cucm/RemoteDestinationProfile)
-

20.2.4. Expose Device Pools and Class of Service in Quick Add Subscriber

Administrators with access to Field Display Policies (FDP) can expose the **Device Pools** field and **Class of Service (CoS)** field on the Quick Add Subscriber (QAS) interface at a specific hierarchy.

1. As an administrator with access to Field Display Policies (FDP), choose **Customizations > Field Display Policies**.
2. Filter the **Target Model Type** on **view/QuickSubscriber**.
3. Depending on which hierarchy or hierarchies the **Device Pools** or **Class of Service** field should be exposed in QAS:
 - a. If the FDP exists at the correct hierarchy, open it.
 - b. If the FDP does not exist at the required hierarchy, clone one of the available FDP's on a higher hierarchy to the required hierarchy (use **Actions > Clone**).
4. Open the FDP and go to the first group's **Available** list in the **Fields** block. Select **device_pool** or **class_of_service**.
5. Click on the **Select** button to move the **device_pool** or **class_of_service** label from the **Available** list to the **Selected** list.
6. Use the **Move up** and **Move down** buttons to move the label to the desired position relative the the other field labels.
7. Ensure that the cloned FDP name is "default", and click **Save**.

If an administrator is at the hierarchy where the cloned FDP is created or at a lower hierarchy, and then navigates to **Subscriber Management > Quick Add Subscriber**, a drop-down field with the title: **Device Pools** or **Class of Service** is exposed.

20.2.5. Configuration

To create or configure users, enable users with services, or associate users with devices, configure the following items on the system.

1. Server Configurations

Configure the following servers in VOSS-4-UC:

- Cisco Unified Communications Manager (Unified CM) Server - Adding a Unified CM server. This server is required to:
 - Sync manually provisioned users or LDAP-integrated users in Unified CM to VOSS-4-UC.
 - Sync any of these users' existing associated Phones, Directory Numbers, Extension Mobility Profiles in Unified CM to VOSS-4-UC.
 - Create Subscribers (push users to Unified CM)
 - Push users' associated Phones, Directory Numbers, Extension Mobility Profiles, to Unified CM.
- LDAP Server. This server is required if you want to configure LDAP-synced users in VOSS-4-UC. If you do not want to configure LDAP-synced users, this server is optional.
- Cisco Unity Connection Server. This server is only required if you want to add Cisco Unity Connection voicemail users that are configured in VOSS-4-UC.

2. Voicemail Service

Deploy Voicemail Service with a pilot number created and associated to a site under **Services > Voicemail** in VOSS-4-UC. This item is required to create a “Default CUC Subscriber Template” under **Site Defaults > CUC Defaults**. The template is required to create Cisco Unity Connection Voicemail users.

3. WebEx Service

Configure a WebxEx Server in VOSS-4-UC to deploy any WebEx users provisioned through QAS. Set a password for WebEx users in Site Defaults.

20.2.6. Quick Add Subscriber Group

Quick Add Subscriber Groups allow administrators to group feature and configuration templates for use with the Quick Add Subscriber and Add Subscriber Wizard functions. This grouping helps to quickly and easily configure subscribers.

For example, if you want to add 100 back-office users and 50 sales users:

- The back-office users all use the 7965 phone with SCCP protocol and no services.
- The sales users all use the 8865 phone with SCCP protocol and Single Number Reach service.

To quickly configure these two groups, create two Configuration Templates:

- One for the 7965 phone with no services for the back-office users.
- One for the 8865 phone with the Single Number Reach service for the sales users.

You also create two Quick Add Groups:

- One for the back-office users which reference the back-office user Configuration Template.
- One for the sales users which reference the sales users Configuration Template.

When adding subscribers with the Quick Add Subscriber and Add Subscriber Wizard functions, choose the appropriate Quick Add Group for the user you are provisioning.

All subscriber services use configuration templates that belong to a Quick Add Group.

20.2.7. Quick Add Subscriber Groups Default Model

Default Group Model for Quick Add Subscriber and Add Subscriber Wizard Functions

Title	Field Name	Configuration Template Name
Group		
Group Name*	group_name	N/A
CUCM and WebEx		
CUCM User Template*	default_cucm_user_template	Default CUCM User Template
Phone Template	default_cucm_phone_template	Default CUCM Phone Template
Extension Mobility Template	default_cucm_device_profile_template	Default CUCM Extension Mobility Template

continues on next page

Table 1 – continued from previous page

Title	Field Name	Configuration Template Name
Line Template	default_cucm_line_template	Default CUCM Line Template
Remote Destination Template	default_cucm_rd_template	Default CUCM Remote Destination Template
Remote Destination Profile Template	default_cucm_rdp_template	Default CUCM Remote Destination Profile Template
Webex User Template	default_webex_user_template	Default Webex User Template
Jabber and Dual-Mode		
Jabber Android Template	default_cucm_jabber_android_template	Default CUCM Jabber Android Template
Jabber CSF Template	default_cucm_jabber_csf_template	Default CUCM Jabber CS Template
Jabber iPad Template	default_cucm_jabber_ipad_template	Default CUCM Jabber iPad Template
Jabber iPhone Template	default_cucm_jabber_iphone_template	Default CUCM Jabber iPhone Template
Carrier Integrated Mobile Device Template	default_cucm_jabber_cim_template	Default Carrier Integrated Mobile Device Template
CTI Remote Device Template	default_cucm_jabber_ctird_template	Default CTI Remote Device Template
CUC(Unity)		
CUC User Template	default_cuc_user_template	Default CUC User Template
CUC User Password Template	default_cuc_user_password_template	Default CUC User Password Template. Quick Add Subscriber applies this template and overrides CUC user template settings on CUC.
CUC User PIN Template	default_cuc_user_pin_template	Default CUC User PIN Template. Quick Add Subscriber applies this template and overrides CUC user template settings on CUC.
WebEx Teams		
Default Webex Teams User Template	default_spark_user_template	Default Webex Teams User Template
Default Webex Teams User CTI Device Template	default_spark_user_cti_device_template	Default Webex Teams User CTI Device Template
Default Webex Teams User iPhone Device Template	default_spark_user_iphone_device_template	Default Webex Teams User iPhone Template
Default Webex Teams User Android Device Template	default_spark_user_android_device_template	Default Webex Teams User Android Template

continues on next page

Table 1 – continued from previous page

Title	Field Name	Configuration Template Name
Default Webex Teams User Tablet Device Template	default_spark_user_tablet_device_template	Default Webex Teams User iPad Template
Default Webex Teams User CSF Device Template	default_spark_user_csf_device_template	Default Webex Teams User CSF Template
Pexip Conference		
Pexip Conference Template	default_pexip_conference_template	Reference Pexip Conference Template
Microsoft		
MS 0365 User Template		
MS Teams User Template		
Additional Services		
VOSS Phone User Template		

Fields marked with * are mandatory.

20.2.8. Quick Add Subscriber Conditions

For details to provision services to users, follow these instructions:

- *Provision the Voice Service*
- *Provision the Extension Mobility Service*
- *Provision the Voicemail Service*
- *Provision the WebEx Service*
- *Provision the Pexip Conference Service*
- *Provision the Single Number Reach Service*
- *Provision the Jabber or Dual Mode Device Service*
- *Provision the Contact Center Agent*
- *Enable Self Provisioning*

When creating users with the Quick Add Subscriber function, consider these conditions:

- A check box called **Send welcome email** is displayed when you type in a user email address *only if* the following configuration has been made and is enabled:
 - An SMTP server has been set up (*SMTP Server*)
 - The **Allow email to be sent to user after Quick Add Subscriber** on **Email** tab of the **Global Settings** is set to **Yes** for the relevant hierarchy (*Global Settings*)

A welcome email is then sent to the subscriber email address using the configured “Quick Add Subscriber” HTML email template that applies to the hierarchy (*Email*)

- From the Quick Add Subscriber Group menu, create a custom group or use the default group.

- You can edit existing users Cisco Unified Communications Manager through Quick Add Subscriber only if the users exist at the Site level.

A check box called **Include users at higher hierarchy** can be displayed by means of a custom Field Display Policy (field name: `lookUpForUser`, hidden by default), so that the **User** drop-down list will also show users above the current site hierarchy. This setting is also available for bulk load sheets and API calls.

- A check box called **Fail Transaction if user not found** can be displayed by means of a custom Field Display Policy (field name: `failIfNotFound`, hidden by default) to prevent adding users not on Cisco Unified Communications Manager. By default, the transaction will not fail. The option is used for the case where users have not been synced from LDAP to Cisco Unified Communications Manager. This setting is also available for bulk load sheets and API calls.
- LDAP synced or LDAP integrated at Cisco Unified Communications Manager user fields are always read-only and cannot be edited.
- You can associate a Line with multiple phones.
- You can associate a Phone with multiple Lines.
- If you choose to add a Phone for the user, the **Phone Name** drop-down list will show available phones at the user's site, according to the Phone Type as specified in the Site Defaults for the site.

The phones available from the drop-down list are those in the associated Quick Add Subscriber Group at the Customer level, which have synced from Unified CM, as well as the phones that are available at the specific site level.

You can also add a new phone if required by entering a valid name in the **Phone Name** field. The Phone Name must consist of a prefix, for instance SEP, followed by a MAC address, which is 12 hexadecimal characters. If you enter the Phone Name incorrectly, for example too few or too many characters, then subsequent associated transactions will fail.

- Associate an Entitlement Profile with the Subscriber.
- You can create multiple devices for a user. Therefore, the **Voice** check box is always visible. When the **Voice** check box is selected, four optional fields are exposed: **Phone Type**, **Phone Protocol**, **Phone Button Template**, and **Phone Security Profile**.
- Values set in the **Phone Type**, **Phone Protocol**, **Phone Button Template**, and **Phone Security Profile** fields will override any existing values in QAG or CFT, as well as the SDD or any other backend CFTs (CFTs that can not be edited). If a field is blank, the existing values in QAG, CFT, SDD or other backend CFTs will be used.

You can override the default **Phone Button Template** value by entering a custom value in the **Phone Button Template** field. The entered value will be applied on Unified CM if the Unified CM allows it for that phone type.

Note: To reduce the likelihood of conflicting QAS settings when completing the optional fields mentioned above, we strongly recommend setting the required fields in the order as displayed on the Quick Add Subscriber screen:

1. Entitlement Profile
 2. Quick Add Group
 3. Voice (Phone Type, Phone Protocol, Phone Button Template and Phone Security Profile).
-

- You can set only one Extension Mobility profile for a user. Therefore, the **Extension Mobility** check box is not visible after you create an Extension Mobility profile.

- You can set only one WebEx account for a user.
- See [Contact Center Agent Quick Add](#).
- You can associate multiple Jabber and Dual Mode devices to a user.
- Jabber and Dual Mode devices get the first line assigned to them that is specified in the QAS form.
- You can create a Directory Number in Unified Communications Manager in two ways:
 - By creating a Voicemail Line in QAS.
 - By creating a Line in QAS.

When you create a Voicemail or Voicemail Line using Quick Add Subscriber, the Directory Number Used field is set to “true” under **Subscriber Management > Directory Number Inventory**.

- A Directory Number created without any device associations (for example, a Voicemail Line) is tagged under **Subscriber Management > Lines** as ‘DN created without device from QAS.’
- When the **Enable Self Provisioning** check box is selected, phone lines are added using the Universal Line Template (ULT) referenced in the Self Provisioning User Profile chosen from the **Self Provisioning User Profile** drop-down list which is exposed upon selecting the check box.

If a User is added with lines but no devices, then selecting the **Enable Self Provisioning** check box automatically sets the CUCM User Primary Extension to the QAS line pattern and ULT route partition. If a user is added with devices and lines, then selecting this check box also automatically sets the CUCM User Primary Extension to the QAS line pattern and ULT route partition.

Choose the required User Profile from the **Self Provisioning User Profile** drop-down list. The available User Profiles are those under **User Management > Self Provisioning > User Profile**. A User Profile must be selected when a user is enabled for Self Provisioning. A default User Profile (as shown under **Site Management > Site-Defaults**) is selected. Change this default if required.

Contact Center Agent Quick Add

Contact Center Management

The Quick Add Subscriber feature supports the easy creation of an CCX agent.

The **Contact Center Agent** check box becomes visible if:

- the associated Entitlement Profile has Contact Center enabled - [Entitlement Profiles Field Descriptions](#)
- a Contact Center Server is available - [Contact Center Servers](#)
- the selected user is not already associated with an Agent

If the check box is selected:

- A **Contact Center Agent Profile** drop-down list is available to select an agent profile.

Note: The **Contact Center Agent Profile** needs to be created before adding the Contact Center Agent from the Quick Add Subscriber feature.

The agent profile will determine the team, resource group and skills assigned to the newly created agent. See: [Agent Profiles](#).

- The **Agent Extension** can be selected.

The extension will be a list of specified Lines, in other words, the administrator must specify the Line to be created or reused before selecting the **Contact Center** check box.

- The **Agent Device Type** can be selected: either Extension Mobility or Phone:
 - If Extension Mobility is selected, the **Extension Mobility** check box is automatically selected.
 - If Phone is selected, the administrator must first enable **Voice** and specify a Phone to be created or reused before checking the **Contact Center** check box.

An IPCC extension is automatically managed for the Unified CM user associated with the Contact Center Agent.

20.3. Lines

20.3.1. Configure Lines

Use this procedure as a high level workflow to configure one or more lines (directory numbers) in VOSS-4-UC. Note that if the Number Inventory feature has been enabled by the administrator, lines are not added; rather, lines are selected from a drop-down list of available numbers.

Note: The Lines interface in VOSS-4-UC provides an easy method to add, modify, or delete individual lines and associated line settings to, or from the system.

Perform these steps:

1. On the **Lines** form, click **Add**.
2. Configure the line and its associated line settings using the following tabs. For more information on the values to fill in for the various line parameters such as partitions and CSS, refer to the “Provider HCS Dial Plan Management Support Guide”.

Note: If the **Enable CSS filtering** check box is selected at the customer dial plan, then for all calling search space fields in this procedure, the list of available calling search spaces includes only those that are marked as a Class of Service under **Dial Plan Management > Site > Class of Service** at the particular site. If another CSS is required, you can add custom CSSs in a CSS field if you know the exact syntax.

If the **Enable CSS filtering** check box is clear, then the list of available calling search spaces includes all CSSs that are configured on the Cisco Unified Communications Manager (Unified CM).

Tab	Description
Directory Number Basic Information	Includes a directory number (mandatory), a route partition, calling search space, call pickup group (to which the line belongs), and other basic settings. The Directory Number field is either a drop-down list or a free text field, or a drop-down containing only the available directory numbers (depending on whether the Number Inventory feature is enabled or disabled). Only the actual Directory Number is mandatory.
Directory Number Advanced Information	Includes various profiles, groups, and advanced settings for the line; for example, MOH Audio Source and voice mail profiles.
Shared Device Info	Shows any phones, device profiles, or remote destination profiles that have been associated with the particular line.
Line Settings for All Devices	Includes fields such as hold reversion ring duration, hold reversion notification interval, party entrance tone (chosen from a drop-down list).
AAR Settings	Automated alternate routing (AAR) handles the calls that are routed to the AAR Destination Mask or Voice Mail.
Park Monitoring	Includes text fields such as park monitoring forward no retrieve destination external or internal voice mail enabled check boxes, park monitoring forward no retrieve destination external, external calling search space, internal, internal calling search space, and park monitoring reversion timer text fields. Note: ¹ If the Enable CSS filtering check box is selected at the customer dial plan, then for all calling search space fields in this procedure, the list of available calling search spaces includes only those that are marked as a Class of Service under Dial Plan Management > Site > Class of Service at the particular site. If the Enable CSS filtering check box is cleared, then the list of available calling search spaces includes all CSSs that are configured on the Unified CM.
Call Forwarded Information	Includes call forward all settings, call forward busy external and internal settings, call forward no answer external and internal settings, and so on.

- When you are finished adding line information, click **Save**. All additions or changes to Lines and line settings in the system are also reflected in the Unified CM. After configuring a line, the transaction menu item (**Administration Tools > Transaction**) can be used to verify the configuration.
- To modify existing line and line setting details, change the settings or add new line settings using the process described in Steps 1 to 6. For example, you can add additional directory URIs and directory URI partitions. Manual configuration must first be done on the Unified CM before URIs will function. Note that not all line settings are configured on the **Lines** form. Device specific settings such as caller ID display, line label, E.164 mask, and associated end user are configured from the **Lines** tab on the associated Subscriber Management **Phones** form.

¹ This only applies to the VOSS-4-UC *Provider* deployment.

20.3.2. Delete Lines

This procedure deletes one or more lines, or line settings.

Perform these steps:

1. Log in as a customer or site level administrator. If you are logged on as the customer administrator for a specific site you can see all the fields described in this procedure. If you are logged in as the site administrator, you can see a subset of the fields that are available on the interface.
2. Choose a site from the hierarchy breadcrumb.
3. Choose **Subscriber Management > Lines**.
4. Choose one of the following methods to delete lines or line settings:
 - Choose an individual line to be deleted by clicking on its box in the leftmost column, then click **Delete**. From the popup window, click **Yes** to confirm the deleted line.
 - Delete multiple lines at once by checking the relevant check boxes, then clicking **Delete**. From the popup window click **Yes** to confirm the deleted lines.
 - Remove line settings from a line as required by removing them from the relevant tab of a selected line. Click **Save**.

Note: If lines are deleted while the numbers are in the Cooling or Reserved status, the numbers only become available once the release date has been reached.

When the delete action is complete, the line disappears from the list.

20.3.3. Add Agent Line (Phone or Device Profile)

Prerequisites:

In order to have an application user available, add a Contact Center server and service:

1. Under **Services > Contact Center > Servers** (default): add a server.
Two SIP Trunks are needed, a CVP and CUBEE on the server.
2. Under **Services > Contact Center > Service** (default): add a service using the above server. This step will create the application users needed when adding an Agent Line.

Perform these steps:

1. From the **Agent Lines** form (default menu **Subscriber Management > Agent Lines**).
2. Click **Add** to add a new agent line.
3. Complete the mandatory fields, consider the following:
 - Device Type*
 - Phone, or
 - Device Profile (Extension Mobility)
 - Profile User* (Device Profile device types only)
Drop-down displays only users who have an extension mobility profile.
4. Click **Save** to add the agent line.

20.3.4. Line Search

The **Line Search** utility enables you to quickly search for all devices and services associated with a selected line.

A **Search Line** drop down of lines is the list of available lines on the Internal Number Inventory (INI) at a selected customer hierarchy and downwards, with used lines indicated as (used). The E164 number associated with the INI is also shown if available.

The devices and services included in the line search are:

- Phones
- Users
- Hunt Groups
- Call Pickup Group
- Device Profile
- Remote Destination Profile
- Voice Mail account

Search results are displayed as a list of grouped identifiers with links that allow you to directly navigate to the individual service or device details.

Note: If the same number is shared by multiple devices/services of the same type, using different partitions, only the first 10 instances will be displayed.

20.4. Intercom Lines

20.4.1. Introduction

The Intercom Lines feature allows for the management of Intercom lines at a site level independently of the management of lines at a site.

Intercom Lines are associated from Phones or Subscribers - they can then be set up and then associated to phones and subscriber phones simply by first selecting the Intercom Route Partition.

20.4.2. Managing Intercom Lines

When the feature is set up, administrators will navigate to a site and then have access to a **Intercom Lines** menu under the **Subscriber Management** menu for the site.

A list view of Intercom lines are shown, where these can be added, deleted and modified.

Directory Number	Description	Alerting Name	Route Partition	Calling Search Space	Call PK
8201140			A1_Intercom-PT	A1_Intercom-CSS	
8201141			A1_Intercom-PT	A1_Intercom-CSS	
8201142			A1_Intercom-PT	A1_Intercom-CSS	
8201143			A1_Intercom-PT	A1_Intercom-CSS	
8201144			A1_Intercom-PT	A1_Intercom-CSS	

The Intercom lines detail form is more simplified than the Lines form, showing only the relevant fields.

Note: Intercom lines should not be managed from the **Lines** menu.

Intercom Lines [8201140]

Intercom Directory Number* 8201140

Route Partition A1_Intercom-PT

Description

Alerting Name

ASCII Alerting Name

Calling Search Space A1_Intercom-CSS

BLF Presence Group Standard Presence group

Default Activated Device

Auto Answer Auto Answer with Speakerphone

When adding or modifying these:

- The **Route Partition** drop-down only shows Intercom partitions.
- The **Calling Search Space** drop-down only shows Intercom calling search spaces.
- For **Default Activated Device**, select the supported device from the drop-down list.
- The **Auto Answer** drop-down only shows supported options.
- If the **Description** field is left blank, it takes a default value “Intercom Line”.

20.4.3. Associating Intercom Lines to Phones

Navigate to a site hierarchy and choose **Phones** under the **Subscriber Management** menu for the site.

To associate an Intercom line on the **Lines** tab of the **Phone** form, first specify an Intercom partition for the **Route Partition Name**.

The simplified Line input form is presented, showing only the supported Intercom line fields to be configured.

The screenshot shows the 'Phones' form with the 'Lines' tab selected. A 'Line' dropdown menu is open, showing a list of existing Intercom lines. The 'Pattern*' field is empty, and the 'Route Partition Name' field is populated with '8201140 \v=494074371140'. Other fields like 'E164Mask', 'Label', 'Display', 'Display Ascii', and 'Speed Dial' are also visible.

- The **Pattern** drop-down *only* shows existing Intercom lines. No new lines can be added.

Intercom and non-Intercom lines can both be associated to a single phone.

Associated Intercom lines will also show as “used” in the list view of the **Directory Number Inventory** menu under **Dial Plan Management** and its **Description** in the list will also show as “Intercom Line”.

Deleting the phone on the **Phones** list view will then also show the Intercom line as not in use.

20.4.4. Intercom Lines in Subscriber Management

Navigate to a site hierarchy and choose **Subscribers** under the **Subscriber Management** menu for the site.

When adding a phone to a subscriber, to associate an Intercom line to the phone on the **Phones** tab, also first specify an Intercom partition for the **Route Partition Name**.

The simplified Intercom Line input form shows only the supported Intercom line fields to be configured.

- The **Pattern** drop-down *only* shows existing Intercom lines, including those in use.

No new lines can be added as a part of Subscriber management - they are added on the **Intercom Lines** menu.

Associated Intercom lines will also show as “used” in the list view of the **Directory Number Inventory** menu under **Dial Plan Management** and its **Description** in the list will also show as “Intercom Line”.

Deleting the phone on the **Phones** list view will then also show the Intercom line as not in use.

20.5. Phones

20.5.1. Phone Type Management

After you make changes to any phone model specific data in Unified CM, for example by loading a new BAT file, editing phone button templates, security profiles, and so on, then in order to utilize that data in VOSS-4-UC, you need to do a sync of the Unified CM.

Include the following models in the data sync - depending on what you changed:

- `device/cucm/PhoneType` - should always be included. Note this includes the expansion modules as well as the phone types.
- `device/cucm/PhoneButtonTemplate` - if button templates were changed
- `device/cucm/PhoneSecurityProfile` - if phone security profiles were modified

If you do a full sync or full import this will make the changes available in VOSS-4-UC. However, between full syncs, it is best practice to create a sync setup with a model type list that includes the above model types. This allows you to run an ad-hoc sync with a very limited scope as needed - if changes are made in the Unified CM that require a sync.

If adding new phone types to the system, you may also need to edit your device groups and entitlement profiles (if used) to have them show as options to the correct users.

20.5.2. Phone Onboarding with Cisco Activation Codes

VOSS-4-UC supports the Cisco Unified CM capability for device onboarding using Activation Codes. This provides a simplified method to register a new phone in the system. This is supported from UCM version 12.5 and later.

This feature allows administrators to create phones without MAC addresses and then share automatically generated activation codes with end users via Self Service or email. The end user can then enter the activation code into the physical device to initiate auto registration.

Once the phone has been activated and registered, the correct phone association takes place in VOSS-4-UC.

For more information on the detailed functionality of the Cisco Activation Code Device Onboarding capability, including supported devices, refer to the Cisco documentation.

The setup of the feature has been incorporated into our various Subscriber/Phone Management capabilities:

- Phones
- Subscribers
- Quick Add Subscriber
- Smart Add Phone

Note: The selected phone type must also be included in the Subscriber's entitlement profile.

Typical Workflow

At a high level in VOSS-4-UC, there are the following setup steps for this feature:

1. Initial Setup - enabling Phone types for activation code.
2. Per Subscriber/Device - setup of the phone details and generation of the activation code.
3. Provide the activation code to the user for use to onboard the device.

To complete the initial setup and enable the phone type(s) for activation code use:

1. Login as customer administrator or higher.
2. It can simplify things to navigate to the hierarchy level of the cluster(s) you want to enable
3. Enable activation code based registration for a target phone type:
 - a. Browse to **Apps Management > CUCM > Device Defaults**.
 - b. Click the **Model**, e.g. Cisco 7821 on which you want to enable the phone registration activation code feature. Note the device column in the list view to ensure it is the device type on the right UCM cluster.
 - c. Select the **Prefer Act Code Over Auto Reg** check box.
 - d. Click **Save**.

To complete the per Subscriber/Device setup to prepare the phone for onboarding:

1. Once enabled, you can add the phone, using any of the prescribed Subscriber Management methods (see above), making sure to select the **Use Activation Code Onboarding** check box. This will remove the device name as a BATXXXXXXXXXXXX device name will be generated when adding the phone.
2. Once the phone has been successfully added, an activation code is generated, and displayed along with the code expiry time on the relevant **Phones** form (**Subscriber Management > Phones**).

Note: The phone activation code must be used to register the phone before the specified expiry date.

3. The activation code is available in the end user's self service if the device was associated to a user. Alternatively email the activation code to the end user.
4. The end user registers the phone by entering the activation code into the physical device.
5. To see the list of phones that have been setup for activation codes but not yet activated, you can filter the phones list view for device names starting with, BAT, as once they register they have the appropriate device name prefix (e.g. SEP).

20.5.3. Configure Phones

Before you Begin

To ensure that the Add Phones work flows execute successfully, create and configure the following items first on Cisco Unified Communications Manager (Unified CM). Then import them into VOSS-4-UC:

- Softkey templates and phone button templates
(Note that Softkey templates can be configured on CUCM but also via VOSS-4-UC.)
- Service parameters and enterprise parameters that must be set for a subscriber service

- Custom SIP profiles
- Service profiles for Jabber
- Phone services

During the end-to-end creation of providers, customers, and sites, default values are created (for example, Site ID). If the dial plan for the site specifies Device Pool, CSS, and Partition names, these are available for selection. To identify these site-related values, refer to the naming conventions used in [Modify Site Defaults](#).

The Site Defaults Menu item populates certain default values for phones. To view and edit the site defaults (depending on your sign-in level), choose **Site Management > Defaults** and click the site name in the list view. For phone parameter information, use the fields on the **General Defaults** and **Device Defaults** tabs. Refer to [Modify Site Defaults](#) for additional information regarding the values to fill in for phone parameters such as partitions and CSSs.

Note:

- If the **Enable CSS filtering** check box is selected at the customer dial plan, then the list of available calling search spaces includes only those that are marked as a Class of Service under **Dial Plan Management > Site > Class of Service** at the particular site. You can add a custom CSS in a CSS field if you know the exact syntax.
- CSS Filtering only applies to HCS dial plans.

If the **Enable CSS filtering** check box is clear, then the list of available calling search spaces includes all CSSs that are configured on Unified CM.

Use this procedure as a high-level workflow to configure one or more phones and associated settings. If the Number Inventory feature is enabled, phone lines are added by selecting a number from a drop-down list of available numbers.

The **Phones** screen is an integrated display to add, modify, or delete the following on the Unified CM device:

- A line
- Devices and device details related to the user
- The association of a line with the user's device
- For a Dual-Mode Phone, any provisioned mobile identity is added to the phone. You can add more remote destinations if necessary.
- The User is updated. For a Dual-Mode Phone, the Mobility User ID Name must be set.

When adding a device for a subscriber, ensure that the following properties of the selected device are related correctly:

- Product
- Protocol
- Security Profile Name
- Phone Template Name. If a new phone is added to Unified CM using COP files, the phone and associated template are only available in VOSS-4-UC after it has been synchronized with Unified CM.

Note: An **Activate Phone Status Service** setting is enabled by default and can be managed by system level administrators. Refer to the Advanced Configuration Guide for details.

When viewing a list of phones, the **status/Fetch real-time phone status** action can be carried out by an administrator who has been assigned a role that has an access profile to enable this action. Carrying

out this operation fetches the Unified CM phone IP address and status *directly* from the Unified CM and displays the data on the **Phones** list view **Registration Status** (for example “None”, “UnRegistered with CUCM-11-5-IP2”, “Registered with CUCM-11-5-IP2”) and **IP Address** columns, updating any existing data shown.

- Since the result of the **status/Fetch real-time phone status** action is in real time, the current status of the list requires that the action be carried out in order to see the latest values.
- There is no cache of data resulting from this action. Any values shown in the columns would not be current, but are the cached values from the RIS data collector if it is enabled.
- When carrying out the **status/Fetch real-time phone status** action, the data in the **Registration Status** and **IP Address** columns can only be viewed:
 - The latest data only shows for the *current* list of phones on the Admin Portal.
 - The data in these columns is not stored in the database and *cannot be exported* or filtered.

Vendor Config

While the **Vendor Config** setting values on the Admin Portal form are “Enabled” or “Disabled, care needs to be taken when setting values in Bulk Loaders, the API or in custom Configuration Templates. Here, they need to be defined as key-value pairs.

On Unified CM, in some cases the value 0 is “Enabled” and in other cases 0 is “Disabled”. It is therefore recommended to set the settings on the Unified CM manually on a sample phone to the desired value and then export the Phone and use these example settings to base your Bulk Loaders, API or custom Configuration Templates settings on.

The required value may change depending on setting which is being applied, for example:

- To *enable* the “Web Access” for a Phone the following needs to be set.
 - Key: `webAccess`
 - Value: 0
- To *disable* “Web Access” for a Phone the following needs to be set
 - Key: `webAccess`
 - Value: 1
- To *enable* “Settings Access” the following needs to be set.
 - Key: `settingsAccess`
 - Value: 1
- To *disable* “Settings Access” the following needs to be set.
 - Key: `settingsAccess`
 - Value: 0

Add and Configure Phones

We recommend using the Smart Add phone feature to add standalone phones and the Quick Add Subscriber feature to add phones to subscribers. See: [Smart Add Phone: Overview](#) and [Quick Add Subscriber: Overview](#).

1. Sign in as a provider, customer, or site level administrator. If you are signed in as the site administrator, you can see a subset of the fields that are available on the interface.
2. Choose site from the hierarchy breadcrumb.
3. Choose **Subscriber Management > Phones**.
4. Click **Add**.
5. Configure the phone and its associated settings using the following tabs.

Tab	Description
Phone	<p>Default values for Device Protocol, BAT Phone Template, Device Security Profile, and other fields are updated automatically based on the selected Product type. The Vendor Config area displays the configurable vendor features available for the selected phone type. Configure each field as required. The fields displayed vary depending on the selected Product (device type) and the Device Protocol (such as SIP or SCCP). The availability of the Vendor Config settings depends on the Field Display Policy.</p> <p>The supported features available for each phone type are retrieved from the related Unified CM.</p> <p>You can override the default Phone Button Template value by entering a custom value in the Phone Button Template field. The entered value will be applied on Unified CM if the Unified CM allows it for that phone type.</p> <p>Tip:</p> <p>If you don't see a template that you are looking for in the drop-down list (for example, for Phone Button Template, Device Security Profile or SIP Profile), edit the template on Unified CM, and then sync the template into VOSS-4-UC to have it appear in the drop-down list.</p> <p>Tip: If the Product type list does not contain the phone or endpoint you want, take the following steps. In Unified CM, install a COP file for the endpoint you want. Install the COP file only once for the Unified CM instance where the endpoint is added. Then in VOSS-4-UC, import the phone button template from Unified CM.</p> <p>Note:</p> <p>Follow these steps while creating a CTI Remote Device to enable Extend and Connect in VOSS-4-UC:</p> <ol style="list-style-type: none"> 1. Enter the Device Name. For example, CTIRD<USERID>. 2. Choose the Product as CTI Remote Device. 3. Choose the Owner User ID from the drop-down list. 4. Choose the SUBSCRIBE Calling Search Space name from the drop-down list. 5. Choose the Rerouting Calling Search Space name from the drop-down list.
Lines	<p>This tab serves two purposes.</p> <ol style="list-style-type: none"> 1. To show all the lines that are associated with the device 2. To associate lines with the device. <p>The Lines sections reflect the Lines object in Unified CM. You can add lines to this group and associate lines with the device. You can add custom lines by entering a line in the drop-down list (depending on the status of the Number Inventory feature).</p>
Speed Dials	<p>Allows you to configure speed dials for the device. Available speed dials depend on the device's Phone Button Template. The order in which Speed Dial entries are added matches the slots that are available in Unified CM.</p>
Services	<p>Used to set IP Phone services.</p>
Busy Lamp Fields	<p>Allows you to configure busy lamps for the device. Available busy lamp fields depend on the device's Phone Button Template.</p>
Blf Directed Call Parks	<p>Allows you to configure Busy Lamp Field directed call parks for the device. Available BLF-directed call parks depend on the device's Phone Button Template. Create BLF-directed call parks in Call Routing > Directed Call Parks on Unified CM before configuring them from this tab. The available BLF-directed call parks match those created for each specific Route Partition Name.</p>

Tab	Description
Dual Mode Settings	Only applies to a Dual Mode Phone, Spark Remote Device, or CTI Remote Device, and allows you to enter the relevant Mobile Identity and Remote Destination (or CTI Remote Destination) parameters for the device. These parameters include Name, Destination Number, Owner User ID, Dual Mode Device Name (or CTI Remote Device), and Answer Too Soon and Too Late Timers.

- **Certificate Authority Functions:**

For details on the fields, refer to [Certificate Authority Functions Fields](#). Note: the date-time value needs to be added *manually* in the format: CCYY:MM:DD:HH:MM.

6. When you are finished adding phones and phone settings, click **Save**.
7. To modify phone and phone settings, use the process described in Steps 1 to 6. When you modify a phone, the following workflow is executed (depending on what was modified):
 - When adding a line, a check is made to see if it exists. If the line does not exist, it is created.
 - When modifying a line, the Link to Line hyperlink on each Line form directs the user to the specific Line relation details. The details can then be modified and saved, after which the user will be returned to the base tab of the Phone form. The user can also navigate back to the Phone by using the back button. When a user's menu layout has more than one entry of line management (`relation/LineRelation`) and associated Field Display Policy, then the form opened by the Link to Line hyperlink will apply the first one (searching from top to bottom) found in the user's menu layout, if one is available.
 - The Phone and User Remote Destination are updated.

Note: If the required Unified CM setting “Customer Support upload URL” is configured at the Enterprise, Profile, or Device level, then the **Action** menu option **Generate Prt Phone** can be used to send a Problem Report Tool (PRT) file to the upload URL.

20.5.4. Phone Status Export

Overview

The Phone Status Export tool allows you to export the status of Unified CM phones based on selected filters. The exported phone status report can be opened from the **File Management** form and downloaded as a `.csv` file. The `.csv` file can be opened as a spreadsheet in Microsoft Excel, where each phone status that matches the configured filters will appear as an individual line.

Create and View a Phone Status Report

1. Browse to the required hierarchy where you want to create the phone status report.

Note: When running the tool from a hierarchy higher than Customer, a Call Manager filter is mandatory.

2. From the **Phone Status Export** form (default menu **Subscriber Management > Status Export**):
 - a. Enter the **File name prefix**.
 - b. In the **Filters** section, define the required filters, namely the mandatory Status and Call Manager (Customer hierarchy only) fields as well as the optional **Device Name**, **Directory Number** and **IP Address** fields, noting the following:
 - Status of **None** = all phones that **do not** have a registration status on the API will appear in the phone status report.
 - Status of **Any** = all phones will appear in the phone status report regardless of the phone registration status.
 - **Device Name**, **Directory Number** and **IP Address** fields: only phones that match these filters are displayed in the phone status report. For example if you enter 'BAT' in the **Device Name** field, then only phones with a device name prefix starting with 'BAT' will appear in the report. The filter on **Device Name** text is case insensitive, for example, 'bat' in the filter will match 'BAT'.
3. Click **Save**. Once complete, the phone status report is saved under **File Management**.
4. Select the required phone status report (file-name-prefixXXXX.csv) from the **File Management** form (default menu **Administration Tools > File Management**) and click **Export** (JSON format).
5. From the resultant .zip file, open the .csv file in Microsoft Excel.

The first column on the report reflects the Phone hierarchy, and subsequent columns provide the (Phone) Name, Status, and information such as: `cm_node`, `ip_address`, `DirNumber`, `DeviceClass`, `Model`, `Product`, and so on (depending on the selected filters).

20.5.5. VOSS Phones

From the **Subscriber Management > VOSS Phones** menu item (default), phones are associated with the VOSS Phone Server (see: [VOSS Phone Server Overview](#) and [Managing VOSS Phone Servers](#))

- **Vendor:** all vendors configured in the library of phone types are offered. See also: [Adding phone types](#).
- **Model:** the phone model is selected. See also: [Adding phone types](#).
- **Number of Lines:** available number is chosen.

These parameters are used to determine the template to use when creating the phone configuration file on the TFTP server.

- **Phone MAC Address:** required, with no vendor prefix as would be used with CUCM. E.g use 123412341234, not SEP123412341234.
- **Group:** is selected. This represents the SIP realm to use for registration. Typically there will be a single realm or group for a customer, although more advanced configuration is possible and may be added to the Phone Server.

- **Line:** each line has the following parameters:
 - **Number:** The directory number from number inventory. Numbers can exist on Phone server phones or CUCM phones, but not both.
 - **Display Name:** The display name for presentation when making a call
 - **Busy trigger:** As per CUCM phones
 - **Max Calls:** As per CUCM phones
 - **Class of service:** This is the class of server as created by the CUCM dialplan. CoS is enforced on CUCM when using HCS mode.

20.5.6. Delete Phones

Use this procedure to delete one or more phones, or phone settings. When phones are deleted, the following occurs:

- The Remote Destination is removed first, so that the VOSS-4-UC cache remains in sync with the Cisco Unified Communications Manager.
- The Phone is deleted.

Note: Lines are not affected.

Procedure

1. Log in as a customer or site level administrator. If you are logged on as the customer administrator for a specific site, you can see all the fields described in this procedure. If you are logged on as the site administrator, you can see a subset of the fields that are available on the interface.
2. Choose a site from the hierarchy breadcrumb.
3. Choose **Subscriber Management > Phones**.
4. Choose one of the following methods to delete phones or phone settings:
 - Choose an individual phone to be deleted by selecting its check box in the far left column, then clicking **Delete**. From the popup window, click **Yes** to confirm the deleted phone.
 - Delete multiple phones at once by selecting the relevant check boxes, then clicking **Delete**. From the popup window, click **Yes** to confirm the deleted phones.
 - Remove phone settings as required by removing them from the relevant tab of a selected phone. Click **Save**.

When the delete action is complete, the phone disappears from the list.

20.5.7. Reset-Restart Site Phones

This feature allows an administrator to reset or restart all phones at a specified site.

Note: This feature only works for devices that are registered with Unified CM.

1. Browse to the required site at which you want to reset or restart phones.
2. Open the **Reset-Restart Site Phones** form (default menu **Subscriber Management > Reset-Restart Site Phones**) and from the **Action to Take** drop-down select either:
 - Reset All Phones. To shut down devices and bring them back up.
 - Restart All Phones. To restart devices without shutting them down.
3. Click **Save**.

Individual phones can also be reset or restarted by clicking on the phone on the **Phones** list view (default menu **Subscriber Management > Phones**):

- Click the **Restart Phone** button to restart a device without shutting it down.
- Click the **Reset Phone** button to shut down a device and bring it back up.

20.5.8. Certificate Authority Functions Fields

This table provides details on the available fields for Certificate Authority Functions when configuring phones - see [Configure Phones](#).

Title	Description
Certificate Operation *	<p>From the drop-down list box, choose one of the following options:</p> <p>No Pending Operation: Displays when no certificate operation is occurring (default setting).</p> <p>Install/Upgrade: Installs a new or upgrades an existing locally significant certificate in the phone.</p> <p>Delete: Deletes the locally significant certificate that exists in the phone.</p> <p>Troubleshoot: Retrieves the locally significant certificate (LSC) or the manufacture installed certificate (MIC), so you can view the certificate credentials in the CAPF trace file. If both certificate types exist in the phone, Cisco Unified CM creates two trace files, one for each certificate type. By choosing the Troubleshooting option, you can verify that an LSC or MIC exists in the phone. For more information on CAPF operations, see the Cisco Unified Communications Manager Security Guide.</p> <p>Default: No Pending Operation</p>
Authentication Mode	<p>This field allows you to choose the authentication method that the phone uses during the CAPF certificate operation. From the drop-down list box, choose one of the following options:</p> <p>By Authentication String: Installs/upgrades, deletes, or troubleshoots a locally significant certificate only when the user enters the CAPF authentication string on the phone.</p> <p>By Null String: Installs/upgrades, deletes, or troubleshoots a locally significant certificate without user intervention. This option provides no security; Cisco strongly recommends that you choose this option only for closed, secure environments.</p> <p>By Existing Certificate (Precedence to LSC): Installs/upgrades, deletes, or troubleshoots a locally significant certificate if a manufacture-installed certificate (MIC) or locally significant certificate (LSC) exists in the phone. If a LSC exists in the phone, authentication occurs via the LSC, regardless whether a MIC exists in the phone. If a MIC and LSC exist in the phone, authentication occurs via the LSC. If a LSC does not exist in the phone, but a MIC does exist, authentication occurs via the MIC. Before you choose this option, verify that a certificate exists in the phone. If you choose this option and no certificate exists in the phone, the operation fails. At any time, the phone uses only one certificate to authenticate to CAPF even though a MIC and LSC can exist in the phone at the same time. If the primary certificate, which takes precedence, becomes compromised for any reason, or, if you want to authenticate via the other certificate, you must update the authentication mode.</p> <p>By Existing Certificate (Precedence to MIC): Installs, upgrades, deletes, or troubleshoots a locally significant certificate if a LSC or MIC exists in the phone. If a MIC exists in the phone, authentication occurs via the MIC, regardless whether a LSC exists in the phone. If a LSC exists in the phone, but a MIC does not exist, authentication occurs via the LSC. Before you choose this option, verify that a certificate exists in the phone. If you choose this option and no certificate exists in the phone, the operation fails. Note The CAPF settings that are configured in the Phone Security Profile window interact with the CAPF parameters that are configured in the Phone Configuration window.</p> <p>Default: By Null String</p>

Title	Description
Authentication String	If you chose the By Authentication String option in the Authentication Mode drop-down list box, this field applies. Manually enter a string or generate a string by clicking the Generate String button. Ensure that the string contains 4 to 10 digits. To install, upgrade, delete, or troubleshoot a locally significant certificate, the phone user or administrator must enter the authentication string on the phone.
Authentication Server	Enter the URL that the phone uses to validate requests that are made to the phone web server. If you do not provide an authentication URL, the advanced features on the Cisco Unified IP Phone that require authentication will not function. By default, this URL accesses a Cisco Unified Communications Self Care Portal window that was configured during installation. Leave this field blank to accept the default setting.
Key Order	<code>keyOrder</code> can be updated only if <code>certificateOperation</code> field is Install/Upgrade,Delete or Troubleshoot. Default: RSA Only
Key Size (Bits)	For this setting that is used for CAPF, choose the key size for the certificate from the drop-down list box. The default setting equals 1024. Other options include 512 and 2048. If you choose a higher key size than the default setting, the phones take longer to generate the entropy that is required to generate the keys. Key generation, which is set at low priority, allows the phone to function while the action occurs. Depending on the phone model, you may notice that key generation takes up to 30 or more minutes to complete. Note The CAPF settings that are configured in the Phone Security Profile window interact with the CAPF parameters that are configured in the Phone Configuration window. Default: 1024
EC Key Size (Bits)	<code>ecKeySize</code> can be updated only if <code>certificateOperation</code> field is Install/Upgrade,Delete or Troubleshoot. Default: 384
Operation Completes By	The completion deadline for the operation (CCYY:MM:DD:HH:MM)

20.5.9. Generate Problem Reporting Tool (PRT)

Individual phones can have the Problem Reporting Tool (PRT) triggered to generate PRT log collection on the phone and upload it to the log server configured on the Unified CM in the “Customer support upload URL” parameter at the Enterprise, Profile, or Device level.

1. Select the phone from the **Phones** list view (default menu **Subscriber Management > Phones**):
2. Click the **Generate Prt Phone** action to generate PRT log collection.

20.5.10. Replace Phone: Overview

Note:

- This software release currently only fully supports the replacement of an existing desk phone type with any other desk phone type.

The Replace Phone feature is typically used when you want to choose a new phone for a user or when a phone type is no longer supported.

The feature provides an easy way to replace an existing (old) phone with a different phone model, while retaining as much of the old phone's configuration as possible. It performs the following:

- copies the old configuration.
- deletes the old phone
- adds the replacement (new) phone along with the old configuration
- updates user information to reflect the change in the controlled devices

Note:

- Speedial, Busy Lamp Field, Blf Directed Call Park, and Services settings are *not* copied from the old phone configuration. Configure these settings manually on the appropriate tab on the replacement phone **Phones** screen if required. See "Configure Phones".
- If the new phone has attributes that were not present on the old phone, you must manually set the required values if the default values are not appropriate. Alternatively, you can select an optional configuration template, which will override the configuration copied from the old phone as well as any manual settings.

If you need a customized Phone Template, a default template can be cloned, renamed and modified from **Customizations > Configuration Templates**. This customization is then available in the **Phone Button Template** drop-down of the Replace Phone feature.

See "Configuration Templates" for more details if required.

20.5.11. Replace a Phone

To replace a phone:

1. Log in as Site administrator or higher.

Note: The Replace Phone feature is *only available at a site hierarchy node*.

2. Choose **Subscriber Management > Replace Phone**. A pop-up window opens to navigate to the site at which the phone is to be replaced.
3. On the **Existing Phone** tab:
 - a. Choose the **Device Name** of the phone that you want to replace.
The Product, Device Protocol, Phone Button Template, and other values are shown automatically as read-only values.
4. On the **Replacement Phone** tab:

Note: If you choose a Phone (Configuration) Template, all other fields available on the **Replacement Phone** tab are redundant. Even if certain fields are populated, the Phone Template values override them.

- a. Enter the **Device Name** of the replacement phone (mandatory).
- b. Choose a **Phone Template** (optional) for the replacement phone if you want to override the attributes copied from the original phone and the manual settings below.

- c. Choose the **Product** (phone model) of the replacement phone (mandatory). Note that if the existing phone was associated with an entitlement profile, then the replacement **Product** drop-down only displays phone types that are allowed by the entitlement profile.
 - d. Choose the **Device Protocol** (mandatory).
 - e. Choose a **Phone Button Template** value for the replacement phone, if one is available (optional).
 - f. Choose the **Security Profile** for the replacement phone (mandatory).
 - g. Enter a **Description** for the phone (optional).
5. Click **Save**.

20.6. Smart Add Phone

20.6.1. Smart Add Phone: Overview

The Smart Add Phone feature provides an easy way to add a phone *only to a site hierarchy node* by selecting the Phone Template that matches the required Phone Product. This selected Phone Template then also adds associated default attribute values. Optionally, you can also choose to add one or more lines and a non-default Phone Button Template for the phone.

When a phone is added using the Smart Add Phone feature, the phone details that were added by the phone template can be seen and modified if needed by selecting the phone from **Subscriber Management > Phones**.

If you need a customized Phone Template, the default template can be cloned, renamed and modified from **Customizations > Configuration Templates**. This customization is then available in the **Phone Template** drop-down of the Smart Add Phone feature.

The line defaults are obtained from the Site Defaults doc for the site. The Default CUCM Line Partition must be set as the partition for the site.

Note: A cloned, custom phone template requires further customization in order to customize the line settings when it is used with the Smart Add Phone feature. For details, refer to the topic on Custom Line Settings for Smart Add Phone Configuration Template in the Advanced Configuration Guide.

20.6.2. Using Smart Add Phone

The Smart Add Phone feature is *only available at a site hierarchy node*.

1. Log in as an administrator.
2. Choose **Subscriber Management > Smart Add Phone**. A pop-up window opens to navigate to the site at which the phone is to be added.
3. Choose the **Phone Template** value that matches the phone to add. The Phone Product and Protocol values are input automatically and become read-only.
4. Optionally choose a non-default **Phone Button Template** value for the phone, if one is available.

You can override the default **Phone Button Template** value by entering a custom value in the **Phone Button Template** field. The entered value will be applied on Unified CM if the Unified CM allows it for that phone type.

5. Based on the selected phone template, the **Device Name** prefix is added for the phone. Complete the device name.
6. The **INI Enabled** field shows if the Internal Number Inventory is enabled for the site or not and the **Default Line Partition** field indicates which default line partition has been set in the Site Defaults doc. Optionally add one or more lines to associate to the phone.

The Lines input is enabled if the default Route Partition value for the site has been set in the site's Site Defaults Doc.

- If the **INI Enabled** is **YES**, then choose a number from the drop-down list of numbers from the Internal Number Inventory. Numbers that are marked as used, are also shown. Lines that are selected, have additional properties set according to the Site Defaults Doc for the site.
- If the **INI Enabled** field is **NO**, then the list of numbers are those Directory Numbers on Unified CM with the Route Partition matching the site. You can choose a number from the drop-down or add a custom number that is not in the drop-down list, in other words, you can type in a number. Lines that are added have additional properties set according to the Site Defaults Doc for the site.

7. Click **Save**.

Choose **Subscriber Management > Phones** to see and modify the phone that is added using the Smart Add Phone feature. Added lines are shown on the **Lines** tab of the **Phones** input form.

20.7. Class of Service

20.7.1. Class of Service

Customer administrators and higher level administrators can create and maintain a Class of Service (CoS) that apply to subscribers. A CoS specifies the Unified CM and Calling Search Spaces (CSS) for a subscriber's line, thereby indicating whether local, national and international numbers can be called.

An administrator can create a CoS at a customer level hierarchy. A Unified CM is specified. A drop-down list of those available at the customer level is shown.

Optional device and line CSSs can also be added - either selected from those existing on the Unified CM, or else added. Macros can also be used when adding new CSSs, for example: `CSS-Gold-{{macro.SITENAME}}`.

When a CoS is modified, the Unified CM cannot be modified. In order to refer to another Unified CM, either clone an existing CoS or else delete it and re-add it.

20.7.2. Add a Class of Service

1. As a customer administrator or higher, and choose **Subscriber Management > Class of Service**.
2. To add new CoS instance, click **Add**. If necessary, this will automatically direct the user to select a customer-hierarchy-level, if not already on it.
3. From the **CUCM** drop-down, choose the desired Unified CM.
4. Enter the Class of Service name in the **CoS Name** field.
5. From the **Device CSS** and **Line CSS** drop-downs, choose the desired CSS types to be associated to this CoS item.

The value can also be a macro that evaluates to a valid CSS type which already exists on the selected Unified CM. Blank values are also allowed.

20.8. Headsets

20.8.1. Headset Management

VOSS-4-UC supports Cisco headset management for Unified CM version 12.5 SU3 onwards. See: [Headset Enablement](#). Third-party headset management may also be supported, depending on the headset type and Unified CM version.

Headset metrics are pulled from Unified CM and displayed on an easy to understand, read-only form in an inventory in VOSS-4-UC. This headset data can be used for:

- inventory tracking of assets and usage
- integration into VOSS Assurance and Analytics for compliance checks, e.g. headset firmware versions, correct headsets, etc.

Subscriber or phone headset data can be viewed in the VOSS-4-UC Legacy Admin Portal, Admin Portal and Business Admin Portal.

Headset templates are also listed and custom templates can be added as required.

Headset Inventory

Note: Headset details on Unified CM are updated dynamically, for example when a headset is either connected or disconnected from a phone connected to the Unified CM.

To ensure regular headset status updates in VOSS-4-UC, we recommend that you create a custom data sync and schedule it to run on a daily basis or more frequently if required. See also:

- [Create a Custom Data Sync](#)
- [Create or Update a Schedule](#)

The **Headset Inventory** list view and instance form (default menu **Subscriber Management > Headset Inventory**) will display the latest headset data after you have executed a sync.

There are two ways a headset can be associated with a user:

- a. when connecting the headset to a phone which is associated to a user.
- b. when a user logs in to the headset. This method is typically used in an extension mobility environment (on Unified CM version 12.5 SU3). The headset is paired to a phone, which automatically logs the user in to the phone.

As soon as a Cisco USB Headset gets connected to, or disconnected from a phone on the Unified CM, the phone automatically provides details about the headset to the Unified CM.

VOSS-4-UC pulls this information from Unified CM, and displays it on the **Headset Inventory** form allowing you to view and track headsets across clusters, providing headset details such as Headset Serial Number, Vendor, Model, Owner, Connected Device Owner, Connection Type, Connected Device Name, and so on.

- **Headset Last Change** is the date and time is the last connected time if a headset is disconnected.

- **Located At** is derived from the location of the phone to which the headset is connected.

Note: For non-Cisco headsets, the Device Name is used as the Serial Number. Using the same non-Cisco headset in multiple phones creates duplicate headset records.

Headset Templates

The headset template allows you to associate User Profiles. The **Headset Templates** list (default menu **Subscriber Management > Headset Templates**) shows the following types of headset templates:

- Standard Default Headset Configuration Template - System default template. This template contains the headset settings supported by the latest headset firmware installed on your system for all your headset model series. You cannot edit the default settings though you can change the profile configuration setting.
- System Generated Custom Headset Template - This template has the headset configuration settings that were manually uploaded to the Unified CM server.
- Custom Headset Configuration Template - create customized headset templates as per your deployment needs:
 - a. Clone an existing template.
 - b. Rename the template.
 - c. Change the configuration as required.
 - d. Save it to the desired hierarchy level.

See also [Cloning Items](#).

Configuration Settings

Field	Description
Name*	Enter a unique name to identify the headset template.
Description	Enter a description that identifies use of the template.
Associated User Profiles	<p>To associate a User Profile to this template, click '+' and select the profile from the drop-down, which displays all User Profiles that are available to use with this headset</p> <hr/> <p>Note: By default, all User Profiles are assigned to the Standard Default Headset Configuration Template. To associate a User Profile to a different template, create the new template and assign the User Profile to the new template.</p> <hr/>
Model Specific Settings	
Models	E.g. 521, 522, 531, 532
Model Series	E.g 500
Model Firmware	<p>Select the required firmware version:</p> <ul style="list-style-type: none"> • Remain on current version - choose this option if you want the headset to remain on the existing firmware version, i.e. the headset firmware version is not upgraded to the latest firmware version on the system. • Latest - choose this option if you want to upgrade the headset firmware version to the latest firmware version on the system.
Firmware parameters	<p>Parameters as set on Unified CM:</p> <ul style="list-style-type: none"> • Name: e.g. SpeakerVolume • Value: integer, e.g. 5 • Access: e.g. User • Usage ID: e.g. 32 <p>One or more parameters can be set.</p>

See also "Headsets" in the Business Admin Portal

20.9. Extension Mobility

20.9.1. Extension Mobility

Extension Mobility (EM) profiles, often referred to as roaming profiles, enable a user to log onto a phone in another location and the phone automatically adopts the profile for that user. An EM profile is required for users who move between locations on a regular basis, or for users in an organization or location, who have been assigned an extension mobility profile rather than a permanent phone.

VOSS-4-UC provides three ways to create, manage and associate extension mobility profiles:

- when adding a subscriber using the add Subscriber workflow - see [Add Subscribers](#) (**Extension Mobility** tab).
- when adding a subscriber using Quick Add Subscriber - see under Quick Add Subscriber: Overview
- when adding a standalone Extension Mobility - see [Standalone Extension Mobility](#).

20.9.2. Standalone Extension Mobility

Standalone Extension Mobility (EM) allows administrators to create and manage all EM profiles at the specified organization level. This is done on the **Extension Mobility** list view (default menu **Subscriber Management > Extension Mobility**).

Managing Extension Mobility

When adding or editing EM profiles you can personalize the EM profile for each user.

Consider the following:

- Extension Mobility Details, such as:
 - Name*. Must be unique and can't be the same as a device name on Unified CM since both are device types. This field is not applicable when editing an EM profile.
- Lines
 - Extension Mobility can be associated to multiple subscribers. If the “Show Numbers belonging to this Subscriber” option is selected from the **Inventory Filter** drop-down, only the directory numbers associated to the first Subscriber on the **Subscribers** tab are displayed.
 - Line settings can only be changed for the original line, not the clones.
 - All line settings changed for a line, automatically apply for the clones of that line, if any.
- Speed Dials. Enables you to manage the speed dial numbers associated with the EM profile.
- Services. EM profiles can be subscribed, unsubscribed and re-subscribed to IP Phone Services such as Intercom Calls, Login/Logout or SingleWire.
- Subscribers. Allows you to associate the EM profile to one or more subscriber.

You can also disassociate an EM profile from a subscriber by clearing the name from the **Username** drop-down and clicking **Save**.

The **Subscriber** 'Link' on an existing EM profile links to the associated Subscriber's **Extension Mobility** form (default menu **Subscriber Management > Subscribers**).

When deleting an extension mobility profile, the following elements are automatically removed/cleared:

- Speed dials
- Busy lamp fields
- Service URL's
- IP phone service subscriptions

See also [Add Subscribers](#) (**Extension Mobility** tab) to add extension mobility to a subscriber during the add subscriber workflow.

20.9.3. Extension Mobility (EM) Login or Logout

VOSS-4-UC allows a site administrator (or higher) to log a user in to or out from one or more phones configured for Extension Mobility at the Customer or Site hierarchy level.

Note: For the feature to work, the phone must be enabled for Extension Mobility **and** the user must have Extension Mobility (Device Profile).

Login User

Log a user in to a phone taking note of the following:

- The **User Name** drop-down (mandatory) contains only users who have Extension Mobility (Device Profile).
- The **Device Profile Name** drop-down is auto populated with the user's first Extension Mobility (Device Profile). If the user has more than one Extension Mobility (Device Profile), choose the profile to use from the drop-down.
- The **Phone Name** drop-down (mandatory) contains only phones that are enabled for Extension Mobility.
- A **Login Duration (in minutes)** of '0' (default setting) indicates that the user will remain logged in to the phone indefinitely. Enter, for example 180, if you want to log out the user from the phone after three hours.
- The **Status** field indicates either the currently logged in user or 'No User Logged In'.
- If you try to log a user into a phone that already has a logged in user, the **Force Login** check box is displayed. Select this check box and click **Save** to simultaneously log out the existing user and log in the new user.

Logout User

To log a user out from a phone:

1. Choose the **Phone Name** from which you want to log out the user and click **Save**.
2. The **Status** field displays either the currently logged in user or 'No User Logged In'.

Logout User from Phones

1. From the **User Name** drop-down (mandatory), choose the user you want to log out from a phone.
2. Move the phone/s from the 'Available' area to the 'Selected' area and click **Save**.

20.10. Subscriber Workflows

20.10.1. Creating Quick Add Subscriber Groups

Procedure

1. Log in as provider, reseller, customer, or site administrator.
2. Choose **Subscriber Management > Quick Add Subscriber Groups**.
3. Click **Add**.
4. In the **Group Name** field, enter a group name. This is a required field.
5. From the **Template** drop-downs, choose the required templates.

For example, take the following steps to create back-office QAS users with phone type 6911 using SCCP protocol (voice account):

- a. From the Default CUCM **Phone Template** drop-down, choose **Backoffice Phone 6911 SCCP**.
- b. From the Default CUCM **Line Template** drop-down, choose **Default CUCM Line Template**. This associates a line with the phone.
- c. You can also use custom configuration templates to assign to a Quick Add Subscriber Group.

Note:

The custom configuration template must be at the same level in the hierarchy as the group.

6. Click **Save**.

20.10.2. Delete a Quick Add Subscriber Group

The default Quick Add Subscriber (QAS) Group resides at the sys hierarchy node.

Note: A QAS Group is required for the QAS function to work.

Procedure

1. Log in and browse to **Subscriber Management > Quick Add Subscriber Groups**.
2. Select the check box next to the Quick Add Subscriber Group you want to delete.
3. Click **Delete**.
4. Click **Yes** from the confirmation popup window to delete the QAS group.

20.10.3. Create Subscribers with Existing Users

Existing Users exist at the Site Level under **User Management > Users**, but are not yet pushed to Cisco Unified Communications Manager.

Procedure

1. Create a custom Quick Add Group or use the default Quick Add Group.
2. Choose **Subscriber Management > Quick Add Subscriber**. Choose a user from the **Username** drop-down list.
The user data fields, such as **First Name** and **Last Name**, display the existing values for the user from **User Management > Users**.
3. From the **Quick Add Group** drop-down, choose a quick add group to assign to the user.
The default value in the Quick Add Group list is "default".
4. If necessary, edit the user information in the **First Name**, **Last Name**, and **Email Address** fields.
5. If necessary, provision the user with services using the **Voice**, **Extension Mobility**, **Voicemail**, **WebEx**, **Pexip**, **Single Number Reach**, **Webex Teams**, **Jabber Dual Mode Device**, and **Enable Self Provisioning** fields.
6. Click **Save**.

20.10.4. Create Subscribers with New Users

New users do not yet exist in VOSS-4-UC and Cisco Unified Communications Manager.

Procedure

1. Choose **Subscriber Management > Quick Add Subscriber**.
2. Choose a user from the **Username** drop-down list.
3. In the **First Name** field, enter the user's first name.
The user's first name is optional but is required if you want to provision the user with a WebEx account.
4. In the **Last Name** field, enter the user's last name.
The user's last name is required.
5. Choose a group to assign to the user from the **Quick Add Group** drop-down list.
The default value in the Quick Add Group list is "default".
6. If required, provision the user with services using the **Voice**, **Extension Mobility**, **Voicemail**, **WebEx**, **Pexip**, **Single Number Reach**, **Webex Teams**, **Jabber / Dual-Mode Device**, and **Enable Self Provisioning** fields.
7. Click **Save**.

20.10.5. Updating Subscribers

Subscribers are users that already exist under User Management > Users and in Cisco Unified Communications Manager.

Procedure

1. Choose **Subscriber Management > Quick Add Subscriber**.
2. Choose a user from the **Username** drop-down list, .
3. The user data fields show the user information found under **User Management > Users**.
Any associated devices or subscribed services for the user appear under the **Existing Services** tab.
4. From the **Quick Add Group** drop-down, select a Quick Add Group to assign to the user.
The default value in the Quick Add Group field is "default".
5. If required, edit the user fields and provision new services to the user.
6. Click **Save**.

20.10.6. Provisioning Services to Users

To provision services to users, follow these instructions:

- *Provision the Voice Service*
- *Provision the Extension Mobility Service*
- *Provision the Voicemail Service*
- *Provision the WebEx Service*
- *Provision the Pexip Conference Service*
- *Provision the Webex Teams Service*
- *Provision the Single Number Reach Service*
- *Provision the Jabber or Dual Mode Device Service*
- *Enable Self Provisioning*

20.10.7. Provision the Voice Service

This procedure provisions a voice service to a subscriber.

1. Go to **Subscriber Management > Quick Add Subscriber**.
2. Select a user from the **Username** drop-down; then, select the **Voice** checkbox.
3. Optionally, select phone details in these fields:
 - Phone Type
 - Phone Protocol
 - Phone Button Template

- Phone Security Profile

Note:

- To prevent conflicting QAS settings, fill out the optional fields in the order displayed on the form.
- Default values depend on the selected Quick Add Group (QAG). New values you define for the optional fields override existing values in QAG, CFT (configuration template), and in any other backend (non-editable) CFTs. The system populates any fields left blank with values from QAG, CFT, SDD (Site Defaults Document), or other backend CFTs.
- The template you select (for example, 'Phone Type'), must exist in the QAG and must be allowed by the entitlement profile, which filters the **Phone Type** drop-down to display only devices enabled by this profile.
- If a phone button template is not specified in QAG, or if the specified phone button template has blank values for the phone fields, the phone field values are pulled from the SDD.
To override the default phone button template, enter a new value in the **Phone Button Template** field. The new value is applied on Unified CM, if it allows the phone type.

-
4. Required. In the **Lines** section, select a line from the **Directory Number** drop-down.

Note: The line must be one of the directory numbers in **Subscriber Management > Directory Number Inventory**.

5. Required. In the **Phones** section, select a phone from the **Phone Name** drop-down.

Important:

- Phones available in this drop-down are:
 - In the assigned Quick Add Subscriber Group, which have possibly synced from Unified CM
 - Available at the specific site
 - Not currently owned by any other userNote that the ability to associate an existing, un-associated phone to a subscriber using Quick Add Subscriber (QAS) depends on the Global Settings setup for Phones.
- If you wish to add a new phone, enter a valid name in the **Phone Name** field. Ensure you enter the phone name correctly (including the correct number of characters).

The phone name must have:

- A prefix (such as SEP)
 - A MAC address (12 hexadecimal characters)
-

To add more phones, repeat this step until you have all the phones you need.

6. Click **Save**.

See also:

- [Global Settings](#)

20.10.8. Provision the Extension Mobility Service

Procedure

1. Choose **Subscriber Management > Quick Add Subscriber**, and choose a user from the **Username** drop-down list.
2. Select the **Extension Mobility** check box.
3. Click **Save**.
4. Choose **Subscriber Management > Quick Add Subscriber**, and choose the same user from the **Username** drop-down list.
5. Choose the **Existing Services** tab, and make sure that the Extension Mobility profile name appears in the **Extension Mobility Profiles** field.

20.10.9. Provision the Voicemail Service

Procedure

1. Choose **Subscriber Management > Subscribers**. From the **Subscribers** list, click on the name of the subscriber to be provisioned with voicemail.
2. Choose the **Voicemail** tab.
3. In the **Voicemail Account** field, click +. The **Voicemail Line** drop-down appears.
4. Choose a line from the **Voicemail Line** drop-down and click **OK**.
For details on the workflow, see [Voicemail Workflows](#).
5. Choose **Subscriber Management > Quick Add Subscriber**, and choose the same user from the **Username** drop-down list.
6. Choose the **Existing Services** tab.
7. Make sure that the voicemail line appears in the **Voicemail Extension** field.

20.10.10. Provision the WebEx Service

Procedure

1. Choose **Subscriber Management > Subscribers**. From the **Subscribers** list, click the name of the subscriber to be provisioned with WebEx service.
2. Choose the **WebEx** tab.
3. In the **Web Ex User** field, click +. The WebEx configuration fields appear.
4. Enter information in the **First Name**, **Last Name**, **Email**, **Password**, and **Repeat Password** fields. Choose **WebEx privileges** in the **Privilege** section.
5. Click **Save**.
6. Choose **Subscriber Management > Quick Add Subscriber**, and choose the same user from the **Username** drop-down list, .

7. Choose the **Existing Services** tab.
8. Make sure that "ACTIVATED" appears in the **WebEx** field.

20.10.11. Provision the Pexip Conference Service

The **Pexip Conference** tab is only available if:

- Pexip Conference service has been configured and is available to the hierarchy (via the Quick Add Subscriber Group).
 - Entitlement Profile: the **Conferencing** check box has been selected and associated to the Subscriber.
1. Choose **Subscriber Management > Subscribers**. From the **Subscribers** list, click the name of the subscriber to be provisioned with Pexip Conference service.
 2. Choose the **Pexip Conference** tab.
 3. In the **Pexip Conference** field, click +. The Pexip Conference configuration fields appear.
 4. Enter information as required, for example:

Field	Description
Description	The name of the conference: contains the Subscriber username
Host PIN	4-20 digits, including any terminal #.
Allow Guests	Enables Guest PIN input. If enabled, the same digit specification as Host PIN applies.
Guest PIN	4-20 digits, including any terminal #. Allows you to set a secure access code for Guest participants who dial in.
IVR Theme	A theme for the conference can be selected or else the default applies.

Refer to the interface tooltips and for details on all the form fields.

5. Click **Save**.
6. To verify: choose **Subscriber Management > Quick Add Subscriber**, and choose the same user from the **Username** drop-down list or verify on the **Pexip Users** menu.
7. Choose the **Existing Services** tab.
8. Make sure that "ACTIVATED" appears in the **Pexip** field.

If the subscriber is deleted, the **Pexip Conference** is either retained or also deleted - according to the Global Settings setting See: [Global Settings](#).

Related Topics

- [Pexip Conferencing Overview](#)
- [Set Up and Manage Pexip Virtual Meeting Rooms \(VMR\) and Conferencing](#)

20.10.12. Provision the Single Number Reach Service

Procedure

1. Choose **Subscriber Management > Quick Add Subscriber**, and choose the user for whom you want to provision Single Number Reach from the **Username** drop-down list.
2. Choose the **Single Number Reach** tab. The SNR Mobile Number field appears.
3. In the SNR Mobile Number field, optionally enter the mobile number. Do not add any spaces or special characters to the number.

The SNR Mobile Number can be the same as the user's Mobile Number shown in **User Management > Users**.

4. Click **Save**.
5. Choose **Subscriber Management > Quick Add Subscriber**, and choose the same user from the **Username** drop-down list.
6. Choose the **Existing Services** tab.
7. Make sure that the Single Number Reach displays the **Single Number Reach** profile name.

The Single Number Reach profile name is the user name followed by "-RDP". For example: jsmith-RDP.

20.10.13. Provision the Contact Center Agent

If the Subscriber is assigned an Entitlement Profile that has the Contact Center service enabled, then the subscriber can be provisioned as a Contact Center Agent. A **Contact Center** tab is then available on the subscriber input form to manage Contact Center Agent properties.

Procedure

1. Choose **Subscriber Management > Subscribers**. From the **Subscribers** list, click the name of the subscriber to be provisioned as a Contact Center Agent.
2. Choose the **Contact Center** tab.

20.10.14. Provision the Webex Teams Service

Webex Teams Feature Reference

Webex Teams can only be provisioned for a subscriber if the **Webex Teams** check box has been selected in the Entitlement Profile associated to the subscriber.

Procedure

1. Choose **Subscriber Management > Subscribers**. From the Subscribers list, click the name of the subscriber to be provisioned with Webex Teams.
2. Choose the **Webex Teams** tab.
3. In the **Webex Teams User** field, click +. The Webex Teams configuration fields appear.

Note: The **Login Enabled** and **Invite Pending** check boxes are read-only fields, and indicate the status of the user, that is whether the Webex Teams account has been activated or not.

Options available in the **Services** and **Roles** sections are dependent on the Webex Teams Server to which the Webex Teams Service is synced (see below for a complete list).

4. In the **Services** section, select the required check boxes:

Message

- **Webex Teams Messaging.** Allows a user to exchange messages and share files with another person or a group of people.

Meeting

- **Webex Teams 25 Party Meetings.** Allows a user to host up to 25-party meetings in Webex Teams cloud spaces.
- **Webex Enterprise Edition 200.** Webex Enterprise Edition.
- **Webex Collaboration Meeting Rooms.** Allows users to come together for one meeting experience irrespective of the devices and software they use – whether that's video conferencing services like WebEx or other systems like Polycom.

Hybrid Calendar Services

- **Microsoft Exchange/Office 365.** Enable for users who have mailboxes in on-premises Exchange or Office 365.
- **Google Calendar.** Enable for users using Google Calendar.

Hybrid Call Services

- **Aware.** Makes Webex Teams “aware” of all calls across your existing unified communications system. Hybrid Call Services Connect (see field below) is dependent on Hybrid Call Services Aware.
- **Connect.** Deployed on top of Hybrid Call Services Aware (see above field) and amongst other things, connects Webex Teams with VOSS-4-UC so that they work together. Enabled = Remote Device created.

Note that with Hybrid Call Service Aware and Hybrid Call Service Connect together, users can make the same calls from either their desk phones or the Webex Teams app as well as hear

incoming calls ring both their desk phones and the Webex Teams app and answer the call on either.

5. In the **Roles** section, configure the required roles by selecting the required check boxes:
 - No administrator privileges
 - Full administrator privileges. Access to all of the portal's features, including: assign roles, company policy and templates, device management licenses and upgrades, etc.
 - Read-only administrator privileges. Can view only whatever privileges are available to the full administrator.
 - Support Administrator. Access to user information and support logs.
 - User and Device Administrator
 - Device Administrator
6. Click **OK** to provision Webex Teams for the subscriber.
7. Make sure that "Enabled" appears in the Webex Teams column of the relevant subscriber on the **Subscribers** screen.

Webex Teams can also be provisioned for a subscriber using Quick Add Subscriber:

1. Choose **Subscriber Management > Quick Add Subscriber**.
2. From the **Username** drop-down list, choose the name of the subscriber to be provisioned with Webex Teams.
3. Choose the **Webex Teams** check box to enable Webex Teams for the subscriber.
4. From the **Webex Teams User Template** drop-down list, choose the template you want to assign to the user.
5. Click **Save** to provision Webex Teams for the subscriber.
6. Make sure that "Enabled" appears in the **Webex Teams** column of the relevant subscriber on the **Subscribers** screen.

20.10.15. Provision the Jabber or Dual Mode Device Service

Procedure

1. Choose **Subscriber Management > Quick Add Subscriber**. From the **Username** drop-down, select a user.
2. Select the **Jabber/Dual-Mode Device** check box. The **Jabber and Dual-Mode Devices** field appears.
3. Click + next to **Jabber and Dual-Mode Devices** to expose the **Jabber/Dual Mode Agent** drop-down and **Device Name** field.
4. Choose a device type from the **Jabber/Dual Mode Agent** drop-down. The **Device Name** field is automatically generated as follows:
 - a. If no device name exists in the format *<device type prefix><username>*, then in this format:
<device type prefix><username>
 - b. If device name exists in the format *<device type prefix><username>* or *<device type prefix><username><number>*, then in the format:
<device type prefix><username><random number>

where *<random number>* is generated and unique.

- *<device type prefix>* - always three characters, either BOT, CSF, TAB, TCT, CIM, or CTI.
- *<username>* - 8 characters maximum. If a username contains ‘_’ and ‘.’ characters, these characters are removed from the automatically generated username. Automatically generated usernames can be edited if required.
- *<random number>* - dependent on length of username, to make up a total of 11 characters along with the username.

See examples in table below.

Example Device Type and Device Name Combinations

For this type of device	Device Name (automatically generated) Format (regex): “[a-zA-Z0-9]{1,15}”
Android (Cisco Dual Mode for Android)	For example: BOTJOHND003938
CSF (Cisco Unified Client Services Framework)	For example: CSFROBWOR77891
iPad (Cisco Jabber for Tablet)	For example: TABRQUENT18947
iPhone (Cisco Dual Mode for iPhone)	For example: TCTPDEVILLI156
Carrier Integrated Mobile	For example: CIMJOHNSMI
CTI Remote Device	For example: CTIJOHNSMI

For the following Agents, also select the **Mobile Identity** check box to enable Mobile Identity if required:

- Android
- iPhone
- Carrier Integrated Mobile

5. Click **Save**.

6. Choose **Subscriber Management > Quick Add Subscriber**. From the **Username** list, choose the same user.

7. Choose the **Existing Services** tab.

8. Make sure that the **Phones** field displays the Jabber device.

For each device type, a Configuration Template that is associated with the Subscriber’s Quick Add Group is used to provision the device. For defaults, see: [Quick Add Subscriber Groups Default Model](#).

Note: If a CSF Jabber device type is selected, all lines are associated to the CSF Jabber device by default.

20.10.16. Enable Self Provisioning

Procedure

1. Choose **Subscriber Management > Quick Add Subscriber**. From the **Username** drop-down list, select a user.
2. Select the **Enable Self Provisioning** check box. The **Self Provisioning User Profile** drop-down appears.
3. From the **Self Provisioning User Profile** drop-down, choose a Self Provisioning User Profile. These were previously created under **User Management > Self Provisioning > User Profile**.
4. In the **Lines** field, click +. The **Directory Number** drop-down appears.
5. Choose a line from the **Directory Number** drop-down.
6. Click **Save**.
7. Choose **Subscriber Management > Subscribers** and choose the same user from the Subscribers list view.
8. Make sure that the **Self Service** and **User Profile** fields display the same settings as those set in Quick Add Subscriber.

20.10.17. Workflow for Deleting Subscribers

You can delete and unprovision subscribers as follows:

- Use the **Subscriber Management > Subscribers** menu path.

Deleting a subscriber works differently based on:

- The Subscriber Type
- The subscriber's Device Associations

Subscribers are typically of these types:

- **Non-LDAP Synchronized Users**
 - Users created in VOSS-4-UC and pushed to Cisco Unified Communications Manager.
 - Users provisioned in Cisco Unified CM and synchronized to VOSS-4-UC.
- **LDAP Integrated at VOSS-4-UC Users**

Users that are LDAP integrated at Cisco Unified CM and synchronized to VOSS-4-UC.
- **LDAP Synchronized Users**

Users that are directly synchronized from an LDAP Server to VOSS-4-UC.

Subscribers can have these associations:

- Associated devices, such as Phones, Extension Mobility, Single Number Reach, Voicemail, and WebEx.
- No device associations.

When you delete a user using **Subscriber Management > Subscribers**, the system performs these tasks, depending on the user type and device associations.

User Type	With Devices	Without Devices
Non-LDAP Synchronized Users LDAP Integrated at Cisco Unified CM Users	Deletes all devices: <ul style="list-style-type: none"> • Phones: device/cucdm/Phone • Single Number Reach: device/cucm/RemoteDestinationProfile • Extension Mobility: device/cucdm/DeviceProfile • Voicemail: device/cuc/User • WebEx: device/WebEx/User Deletes the Provisioning Status.	Deletes the Provisioning Status.
LDAP Synchronized Users	Deletes all devices: <ul style="list-style-type: none"> • Phones: device/cucdm/Phone • Single Number Reach: device/cucm/RemoteDestinationProfile • Extension Mobility: device/cucdm/DeviceProfile • Voicemail: device/cuc/User • WebEx: device/webex/User Deletes the user from Cisco Unified CM: device/cucm/User Removes the Cisco Unity Call Manager from the Provisioning Status.	Deletes the user from Cisco Unified CM: device/cucm/User Removes the Cisco Unity Call Manager from the Provisioning Status.

20.11. Line Reports

20.11.1. Create Line Reports for a Site

This procedure creates a report of all lines configured at a site.

Note: You can use the report information to determine which lines you must move before deleting the site.

The report shows:

- The hierarchy node of the line's corresponding DN inventory
- Whether the line is shared within the site
- A list of all the phones that reference the line
- The owner and hierarchy node of each phone that references the line

Perform these steps:

1. Log in as provider, reseller, or customer administrator.
2. Set the hierarchy path to the customer for which you want to create a site line report.
3. Choose **Administration Tools > Reports > Create Line Report**.
4. From the **Site Hierarchy** drop-down, choose the site for which you want to create the line report.
5. Click **Save**.

A line report for each line in the selected site is generated.

Next Steps

View line reports.

20.11.2. View Line Reports

This procedure displays the line reports.

Perform the following steps:

1. Log in as provider, reseller, or customer administrator.
2. Set the hierarchy path to the customer for which you want to view line reports.
3. Choose **Administration Tools > Reports > Line Reports**.

A list of line reports is displayed containing this information:

Column	Description
Pattern	Directory Number of the line.
Partition	The route partition of the line. The pattern combined with the partition defines the uniqueness of the line in CUCM.
Line Hierarchy	Hierarchy where the CUCM line with this pattern and partition is defined.
DN Inventory Hierarchy	Hierarchy where the DN inventory for the pattern is defined. If empty, no DN inventory exists for this pattern.
Device Count	Number of Phones, Device Profiles, and Remote Destination Profiles remote across all sites that are referencing this line.
Used Across Sites	Indicates whether at least one phone which exists in a different site references this line.
Shared Within Site	Indicates whether this line is shared between multiple phones within the site where the line exists.
Timestamp	Time when the report was generated.
Hierarchy	Hierarchy of the customer for which the report was generated.

4. To see additional information about Phones, Device Profiles, and Remote Destination Profiles related to a line, click the required line report. The **Line Reports** screen displays this information about Phones, Device Profiles, and Remote Destination Profiles:

Phones

Column	Description
End User	The user ID of the CUCM user who owns this phone.
Phone Name	Device name of the phone which references the line.
Hierarchy	Hierarchy where the phone exists which references the line.

Device Profiles

Column	Description
End User	The user ID of the CUCM user who owns this Device Profile.
Device Profile Name	Name of the Device Profile which references the line.
Hierarchy	Hierarchy where the Device Profile exists which references the line.

Remote Destination Profiles

Column	Description
End User	The user ID of the CUCM user who owns this Remote Destination Profile.
Remote Destination Profile Name	Name of the Remote Destination Profile which references the line.
Hierarchy	Hierarchy where the Remote Destination Profile exists which references the line.

Next Steps

To avoid letting too many line reports accumulate, delete them individually or select the check boxes on the **Line Reports** list view and click **Delete** to delete multiple reports.

20.12. Customization Reports

20.12.1. Audit Template Customizations

You can run the template customization audit tool on a selected hierarchy node to identify template definitions and instances that were not delivered in the standard template packages during an installation or upgrade.

The audit report includes custom model schema definitions as well as data, domain, and view instances created on the hierarchy node as a result of workflow execution.

Use the report to verify that there are no unexpected instances at the specified hierarchy node.

Procedure

1. Log in as a customer administrator or higher.
2. Set the hierarchy path to the level from which you want to run your audit.
From a given hierarchy node, you can audit customized templates at the node, and at nodes directly above or below the node in the hierarchy tree.
3. Choose **Administration Tools > Reports > Audit Template Customization**.
4. Choose the hierarchy node for which you want to audit customized templates.
5. Click **Save**.

What to Do Next

View the audit report. See “View Template Customization Audit Reports”.

20.12.2. View Template Customization Audit Reports

Procedure

1. Log in as provider, reseller, customer, or higher level administrator.
2. Choose **Administration Tools > Reports > Template Customization Reports**. A list of template customization audit reports is displayed.
3. Click a report to view the details. The message field shows how many customized templates were found at the hierarchy node. The details fields lists the model type and instance of each customized template.

20.12.3. Example Template Customization Audit Reports

The purpose of a Template Customization Audit Reports is to provide a record of changes as a result of workflow execution at a particular hierarchy, in particular:

- data, relation, and view instances of standard models that include for example Configuration Templates, Field Display Policies, Macros.
- custom model schema definitions that may have been created at the site (for example, instances of `data/DataModel`) as a result of a custom adaptation.

Consider an example customization report that was created at a Site hierarchy called: `LOC001`.

After the report is created from the **Administration Tools > Reports > Audit Template Customization** menu, it shows as an item in the list of reports on the **Administration Tools > Reports > Template Customization Reports** menu.

The report can be identified by checking the creation Timestamp and Message columns of the list. The message would contain the number of templates and the phrase that shows the Site hierarchy, for example:

```
544 customized templates were found at sys.hcs.CS-P.CS-NB.AAAGlobal.LOC001
```

The Details list in the report shows entries of the format:

```
Model Type: data/User, \
Instance: bkey(["QAS0003", "hcs.CS-P.CS-NB.AAAGlobal.LOC001"]), \
pkid(5949dd115da9aa9559aa2386)

Model Type: data/ConfigurationTemplate, \
Instance: bkey(["Reference CUCM User Template", \
               "device/cucm/User", \
               "hcs.CS-P.CS-NB.AAAGlobal.LOC001"]), \
pkid(5949dcd15da9aa9559aa1b2d)

Model Type: data/Macro, \
Instance: bkey(["CUSTOMER_INI_ENABLED", \
               "hcs.CS-P.CS-NB.AAAGlobal.LOC001"]), \
pkid(5949db2a5da9aa9559aa01d9)
```

From the list details, it is possible to see the model instances created at the site - defined by type, business key and pkid.

This provides administrators with information when inspecting data at a hierarchy for troubleshooting or for reference when contacting support operators.

20.13. Voicemail

20.13.1. Voicemail: Overview

The Voicemail interface (default menu **Subscriber Management > Voicemail**) allows an Administrator to add, modify or delete Cisco Unity Connection (CUC) Voicemail users and their associated Voicemail services from a single tabbed form.

The users and associated services added through VOSS-4-UC are also added to Cisco Unity Connection Voicemail system.

Complete the required fields on the tabs and click **Save**. The following can be added or edited using the Voicemail interface:

- CUC Account - details such as Voicemail Account Name*, Voicemail Number* and Language That Callers Hear. See also [Unified Messaging Account](#) (only one per subscriber can be added in VOSS-4-UC).

Consider the following:

- When adding a new Voicemail account and selecting an existing subscriber from the **Voicemail Account Name** drop-down, the **Voicemail Number** drop-down only shows numbers associated to the selected subscriber.
- If you select an existing subscriber the email address is auto-populated.
- Alternate Extensions. Alternate extension numbers available to the CUC Voicemail user. See also [Add Alternate Extension](#).
- Message Actions. Actions to determine how incoming Voicemail, Email, Fax and Receipt messages are handled. If the selected message action involves relaying the message, you must enter a valid email address in the **Relay Address** field.
- Credentials. Password and PIN configuration.
- Notification Devices. Devices used to notify the CUC user of Voicemails sent to the user. **SMS** notification is only available if an SMPP Provider has been added on the relevant Voicemail server. See also [Add Additional Notification Devices](#).
- Caller Input. These associate the caller input keys to specific actions. You can choose an action to associate with each key by choosing it from a drop-down list. See also [Manage Voicemail Caller Input Keys](#).

20.13.2. Voicemail Workflows

A Voicemail account can only be added if:

- The administrator has navigated to the relevant Provider, Customer, Site level.
- A CUC Server (VM Server) has already been provisioned at the Provider or Customer level.
- A Network Device List (NDL) and NDLR points have already been created.

When adding a new Voicemail account, the following workflow is executed:

1. A CUC account is added with the details input by the user.
2. Alternate extensions are added with the details input by the user (if applicable).
3. Message actions are initially added with defaults, but can be updated with details input by the user if the Subscriber has been added, or upon modification.
4. Credentials (password and PIN) are added with the details input by the user. The password and PIN can either be locked by the administrator, or the user can be prompted to change the credentials upon first login. The CUC User Password Template and CUC User PIN Template in the user's Quick Add Group are applied - see [Quick Add Subscriber Groups Default Model](#).
5. Notification Devices are added. The system automatically provisions default notification devices, however additional notification devices can also be added when adding a Voicemail account.
6. Caller Input keys are updated or added as configured by the user.

You can modify either an existing Voicemail account service information (details that were added to a Voicemail account during the Add Voicemail process), or you can modify a Voicemail account by adding new Voicemail services (those that were not added to the Voicemail account during the initial Add Voicemail process). For example, you can add additional alternate extensions and/or notification devices. After adding a Voicemail service to a subscriber, any lines that are used by any of the devices associated to the subscriber are updated to reflect the proper call forward and Voicemail profile settings to enable the Call Forwarding to Voicemail and Voicemail buttons.

When modifying a Voicemail account, the workflow and processes are executed as with the Add workflow.

- Modular Add and Delete workflows can be carried out. For example, if more than one alternate extension or notification device is added to the Voicemail account, a pop-up form is available on the appropriate **Alternate Extensions** tab or **Notification devices** tab. Alternatively, for one-to-many or zero-to-many item instances such as an alternate extension, it can be deleted. These Add and Delete operations carry out a secondary workflow on the Voicemail instance.

When deleting a Voicemail account, the following should be noted about the workflow:

1. All elements associated with the Voicemail account are deleted.
2. Modular Delete workflows can be carried out as a part of a Modify workflow.

Note:

- When a Voicemail account is deleted at Site level, the related CUCM Line's Park Monitoring and CFWD settings are disabled accordingly.
 - When a Voicemail account is deleted at Customer level, i.e. recently synced from CUC but not yet moved to Site level, the related CUCM Line's Park Monitoring and CFWD settings *are not disabled*.
-

20.13.3. Unified Messaging Account

Overview

Unified Messaging (Single Inbox) is a Cisco Unity Connection service that enables users to have a single inbox in their e-mail client that is used for their e-mail as well as their Voicemail.

Note:

- VOSS-4-UC only supports either the Exchange or Office 365 Unified Messaging Service, MeetingPlace is **not** supported.
- Only **one** Unified Messaging Account (Single Inbox) per Subscriber can be added by VOSS-4-UC. However, if an existing Cisco Unity Connection subscriber is imported into VOSS-4-UC already has more than one account, then all associated services are imported, and will be available in VOSS-4-UC.
- Administrators must manually sync VOSS-4-UC with Cisco Unity Connection to obtain the required Unified Messaging Services. A manual sync must also be done whenever changes are made to the Cisco Unity Connection server.
- VOSS-4-UC does not automatically integrate Cisco Unity Connection Servers with Microsoft Exchange, the details for that process can be found here: https://www.cisco.com/c/en/us/td/docs/voice_ip_comm/connection/11x/unified_messaging/b_11xcucumgx.html

The following Cisco Unity Connection settings, set to 'True' (On), are included in Unified Messaging:

- EmailAddressUseCorp - Use Corporate Email Address
- EnableMailboxSynchCapability - Synchronize Connection and Exchange Mailboxes (Single Inbox)

The following two models were added to the Model Type List **CUCXN Overbuild Resources** for Unified Messaging:

- device/cuc/ExternalService
- device/cuc/ExternalServiceAccount (the actual Cisco Unity Connection User's model which contains their Unified Messaging Account)

VOSS-4-UC also added a new Model Type list **CUCXN Unified Messaging Services**, and added the same two Models: device/cuc/ExternalService and device/cuc/ExternalServiceAccount

Procedure

1. Choose **Subscriber Management > Voicemail**.
2. Click on the subscriber for whom you want to add the unified messaging service.
3. On the **CUC Account** tab, click **Unified Messaging Account +** and choose the **Unified Messaging Service** from the drop-down list.
4. Click **Save** when complete.

20.13.4. Add Alternate Extension

Procedure

1. Log in and navigate to the customer level hierarchy.
2. Choose **Subscriber Management > Voicemail** (default).
3. From the **CUC Account** tab, enter the account information.
4. From the **Alternate Extensions** tab, select the '+' next to **Alternate Extensions**.
5. Enter the user **Number** and choose the **Phone Type** from the drop-down, then enter the **Name** and choose the **Partition Name** from the drop-down.
6. Click **Save**.
7. Log into Cisco Unity Connection.
8. Choose the User you have been updating.
9. Choose **Edit > Alternate Extensions**.

The Alternate Extension will be in place if configured from VOSS-4-UC.

10. From **Alternate Extension** choose the Partition from the drop-down and click **Save**.

20.13.5. Add Additional Notification Devices

Procedure

1. Log in and navigate to the Customer Level Hierarchy.
2. Choose **Subscriber Management > Voicemail** (default).
3. Choose the required subscriber to whom you want to add the notification devices.
4. Click the **Notification Devices** tab.
5. Add notification devices, such as **SMTP, Phone, Pager, SMS** or **HTML** by clicking the '+' next to the notification device, selecting the **Active** check box, and entering the required fields. Repeat for other notification devices if required.
6. Click **Save** when complete.

The selected additional notification devices will be added to the subscriber.

20.13.6. Manage Voicemail Caller Input Keys

You can edit caller input keys for an existing Voicemail user.

1. Log in as site administrator or higher.
2. Make sure that the hierarchy path is set to the correct node.
3. Choose **Subscriber Management > Voicemail**
4. Click on the Voicemail user you want to edit or click **Add**. For the **Add** transaction only, a **CUC Account**, including **Voicemail Account Name** must be created and saved before the **Caller Input** tab is active.

5. From the **Caller Input** tab, configure the default caller input keys:
 - a. Click on the required key (*, #, or 0 to 9).
 - b. Choose the action for the key from the drop-down list, see [Caller Input Tab](#).

Additional fields are exposed when choosing certain options. For example, when you choose the **User with Mailbox** call action, the **User with Mailbox** and **Transfer / Greeting** fields are exposed.

6. Click **Save** when complete to save the caller input settings.

Related Topics

- [Modify a Call Handler \(Auto Attendant\) in the Core Feature Guide](#)

20.14. Conferencing

20.14.1. Conferencing: Overview

Conferencing Services supported by VOSS-4-UC:

- Webex
- Pexip (see [Pexip Conferencing Overview](#))
- Zoom

Site administrators manage the conferencing credentials of users if a Conferencing server is available at the site level. The Conferencing server on which users are administered can be identified with the Network Device Reference of the site, or else (according to the common reference resolution process) with the first such server in the current or higher up hierarchy level.

The default Conferencing input form that provides the interface to Conferencing users displays the minimum of Conferencing user properties that are mandatory. The Field Display Policies and Configuration Templates for this Conferencing input form can be modified according to the suggested customization procedure for Policies and Templates.

For Conference Workflows to function, make sure that the following is done at the Customer:

- A Conferencing server is added.
- The Conferencing server is added to a Network Device List (NDL).
- The required site references the relevant NDL.

WebEx Conferencing for Subscribers

If conferencing was added for a Subscriber user when the Subscriber was added, the WebExId is defaulted to the userid. Note that the WebEx user properties that are shown on the Subscriber form may not correspond with those shown on the Conferencing input form. If the Conferencing feature is to be added for an existing subscriber, make sure that the WebExId is the same as the userid.

20.14.2. Pexip Conferencing Overview

Pexip is a conferencing platform that provides users with their own personal Virtual Meeting Rooms (VMRs), to hold conferences, share presentations, and chat.

VOSS-4-UC integrates fully with Pexip, providing access to the following:

- [Set Up and Manage the Pexip Server](#)
- Set Up and Manage Pexip Virtual Meeting Rooms and Conferencing:
 - [Set Up and Manage Pexip Virtual Meeting Rooms \(VMR\) and Conferencing](#)
 - Provision the Pexip Service: [Provision the Pexip Conference Service](#)
 - IVR Theme for a Pexip Conference
- Resetting the Pexip PIN (see [Resetting UC Passwords](#))
- Pexip Conferencing upon subscriber deletion: [Global Settings](#)

20.14.3. Set Up and Manage Pexip Virtual Meeting Rooms (VMR) and Conferencing

1. To manage Virtual Meeting Rooms (VMR), choose **Subscriber Management > Pexip Conference Users** menus. You will be prompted to select a hierarchy.
2. The **Name** and **Owner's email address** are mandatory fields.
3. If used, the **Host PIN** can be reset on [Resetting UC Passwords](#).
4. If you select **Allow Guests**, an input box is shown to enter the **Guest PIN**.
5. Complete the required fields and click **Save**.

The name of the VMR will now show on the list of the Virtual Meeting Rooms from the Services on the Pexip Conferencing Platform. Any changes to the VMR on the Pexip Conferencing Platform will also update the VMR in VOSS-4-UC.

Virtual Meeting Rooms are set up as a part of User management - see:

- [Add Subscribers](#)
- [Quick Add Subscriber: Overview](#)
- [Provision the Pexip Conference Service](#)

20.14.4. Conference Workflows

User details can be added if a valid server is available.

When adding Conferencing from this input form, the mandatory fields are entered on the Conferencing server.

Conferencing details can also be added as part of Subscriber Management.

- For WebEx:
 - If the WebEx Id is a VOSS-4-UC 10.6(x) or later version, and Unified CM username of a Subscriber, the WebEx details are displayed on its Subscriber Management screen WebEx tab.

Modify Conferencing details on the selected item, or also add and delete details from the Subscriber Management form.

Deleting a Conference item will remove the details from the Conferencing tab of Subscriber Management if the user is a Subscriber.

20.15. Webex Teams Users

20.15.1. Webex Teams: Overview

Webex Teams is a Cloud-Based Business Collaboration Service, which allows employees to message, meet, and call instantly in order to strengthen relationships and increase productivity.

Webex Teams combines mobile devices and other communications tools to provide instant communications and live meetings to ensure a professional and effective collaboration experience.

Webex Teams main functionality includes:

- **Messaging.** Business messaging allows users to prepare, share, and repeat content. It facilitates one-on-one or team messaging facilities in virtual rooms.
- **Meeting.** Connect teams and meet customers easily with the added benefits of messaging and content sharing before, during, and after the meeting.
- **Call.** The service enables voice and video communications via mobile, desktop, and room-based devices. Connect your existing PSTN1 services to Webex Teams to enjoy one-touch directory dialing and join meetings from anywhere on any device. Mobile users get features such as single number reach, single voicemail service, video services, and the ability to seamlessly move between devices during a call.

Note: Configure a specific Subscription for organizations with multiple License Subscriptions, in other words where there is a single organization with more than one entitlement for a specific license, such as “Messaging”.

Webex Teams Feature Reference

- Webex Teams Services:
 - [Webex Teams Feature Workflow](#)
 - [Create Webex Teams Service](#)
- Webex Teams Users:
 - [Provision the Webex Teams Service](#)
 - [Add Webex Teams User](#)
 - [Delete Webex Teams User](#)
 - [Webex Teams User CSV files](#)
 - [Bulk Update Webex Teams Users](#)
 - [Webex Teams Licenses](#)
 - [Add Subscribers \(Webex Teams tab\)](#)

- Webex Teams Workspaces:
 - [Webex Teams Workspaces](#)
 - [Manual Steps](#)

20.15.2. Add Webex Teams User

Webex Teams Feature Reference

Use this procedure to add a Webex Teams User in VOSS-4-UC.

1. Log in as provider, reseller, customer, or site administrator.
2. Choose **Webex Teams > Users**. The **Webex Teams Users** screen is displayed showing all Webex Teams Users (synced, or added in VOSS-4-UC).
3. Click **Add** on the button bar.
4. Choose the required site from the **Hierarchy** drop-down to which you want to add the Webex Teams user and click **OK**.
5. Enter the following information on the **Webex Teams Users** input form:
6. On the **Account Details** tab complete, at minimum, the mandatory fields:
 - First Name
 - Last Name
 - Email Address*. This is a mandatory field. Also used to match users being moved during the overbuild process.
 - Login Enabled. Read only field. Check box selected = Only visible if the user has activated their Webex Teams account by accepting an email inviting them to join Webex Teams.
 - Invite Pending. Read only field. Check box selected = User has not yet responded to an email inviting them to join Webex Teams. Only visible once this form has been completed (steps 7 and 8), saved (Step 9) and then refreshed.

The Status read only field shows for created users. A textual description of the user status based on Login Enabled and Invite Pending. For example: "The user has never logged in; a status cannot be determined".

If native calling is enabled, **Phone Numbers** and **Extension** fields can be exposed for the user.

7. On the **Services** tab, choose the required enabled **Services** for the user by selecting the check boxes:

Message

- Webex Teams Messaging. Allows a user to exchange messages and share files with another person or a group of people.

Meeting

- Webex Teams 25 Party Meetings. Allows a user to host up to 25-party meetings in Webex Teams cloud spaces.
- Webex Enterprise Edition 200. Webex Enterprise Edition.
- Webex Collaboration Meeting Rooms. Allows users to come together for one meeting experience irrespective of the devices and software they use – whether that's video conferencing services like WebEx or other systems like Polycom.

Hybrid Calendar Services

- Microsoft Exchange/Office 365. Select for users who have mailboxes in on-premises Exchange or Office 365.
- Google Calendar. Enable for users using Google Calendar.

Hybrid Call Services

- Aware. Makes Webex Teams “aware” of all calls across your existing unified communications system. Hybrid Call Services Connect (see field below) is dependent on Hybrid Call Services Aware.
- Connect. Deployed on top of Hybrid Call Services Aware (see above field) and amongst other things, connects Webex Teams with VOSS-4-UC so that they work together. Enabled = Remote Device created.

Note that with Hybrid Call Service Aware and Hybrid Call Service Connect together, users can make the same calls from either their desk phones or the Webex Teams app as well as hear incoming calls ring both their desk phones and the Webex Teams app and answer the call on either.

If calling is enabled for the user, a **Calling** group of controls also shows under the **Services** tab.

8. On the **Roles** tab, choose the **Roles** for the user by selecting the check boxes:
 - No administrator privileges
 - Full administrator privileges. Access to all of the portal’s features, including: assign roles, company policy and templates, device management licenses and upgrades, etc.
 - Read-only administrator privileges. Can view only whatever privileges are available to the full administrator.
 - Support Administrator privileges. Access to user information and support logs.
 - User and Device Administrator
 - Device Administrator
9. Click **Save** on the button bar when complete to add the Webex Teams User.

20.15.3. Delete Webex Teams User

Webex Teams Feature Reference

Use this procedure to delete a Webex Teams user (synced, or added via VOSS-4-UC).

1. Log in as provider, reseller, customer, or site administrator.
2. Set the hierarchy to the Customer or Site level.
3. Choose **Subscriber Management > Webex Teams Users**.
4. Select one or more check boxes next to the Webex Teams Users you want to delete, and then click **Delete**.
5. Click **Yes** to continue to delete or **No** to abort the process.

20.15.4. Webex Teams User CSV files

If the Global Setting **Generate and send Webex Teams User CSV file via Webex Teams message** is enabled, any add or update of a Webex teams user will create a CSV file and attach it to an email message to the recipients specified. The message is sent through the Webex Teams message service.

The CSV file can be imported into Webex Teams Control Hub to update the users.

This task can also be carried out in bulk:

1. Navigate to the hierarchy of your Webex Teams users and choose the **Generate User CSV Inport File** menu.
2. Enter a **Recipient Email Address**
3. Click **Save**

An email message with CSV attachment containing the data of all the Webex Teams users is sent. See: [Global Settings](#) for an email message example.

Formatted example of CSV file:

User ID/Email (Required)	Jabber with Webex Teams	Jabber Calling	UC Manager Profile	Contact Migration Required	Calling Behavior	Cal
mvs_user20@aaaglobal.com	FALSE	FALSE		FALSE	USE_ORG_SETTINGS	
testext1@test.com	FALSE	FALSE		FALSE	USE_ORG_SETTINGS	
adent@marclight.com	FALSE	FALSE		FALSE	USE_ORG_SETTINGS	
lwilson01@aaaglobal.com	FALSE	FALSE		FALSE	USE_ORG_SETTINGS	
kevin.green@marclight.com	FALSE	FALSE		FALSE	USE_ORG_SETTINGS	
jmeyers01@aaaglobal.com	FALSE	FALSE		FALSE	USE_ORG_SETTINGS	
email.tyler@marclight.com	FALSE	FALSE		FALSE	USE_ORG_SETTINGS	

20.15.5. Bulk Update Webex Teams Users

The **Bulk Update Webex Teams Users** menu provides controls to generate CSV files to carry out bulk tasks upon its import into Webex Teams Control Hub.

1. Choose **Webex Teams > Bulk Update Webex Teams Users**. You will be asked to choose a customer level or lower hierarchy where the Webex team users are.
2. To filter the users at this hierarchy, select a **User Filter**, for example all users or only users with Hybrid Calling enabled.
3. Select the **User Template** containing the settings to apply to the filtered users, for example to provide messaging only, select the Webex Teams User Messaging Only Template.
4. Choose whether to generate a combined CSV file for the hierarchy or individual files for each user, or both - thereby generating multiple files.
5. Enter the **CSV Recipient Email Address**. This defaults to the VOSS-4-UC administrator email address.
6. If necessary, further selection of the users can be carried out by moving only some of them from the **Available** to the **Selected** side-by-side boxes. Else move all users.
7. Click **Save** to send the message and CSV file attachment.

20.15.6. Webex Teams Workspaces

Workspaces of various types - such as Meeting rooms or open spaces can be defined in VOSS-4-UC.

The data entered on this input form is formatted as a sequence of steps in an email message to be carried out on the Webex Teams Control Hub. See: [Global Settings](#) for an email message example.

1. Provide a workspace **Name**, **Capacity** and select a workspace **Type**.
2. Use the **Send Device Activation Code To** field for the email address(es) where the device type code is sent. This code is unique to this created workspace and is entered into the device itself.

Once the code is created, the **Device Activation Code** (read only) value is returned and shown, as well as its **Device Activation Code Expiration Date**. A VOSS-4-UC schedule checks the expiration date and generates a new code. The **SIP Address** of the workspace is also shown.

The **Calling** group has options for the **Calling Behavior** (free or hybrid) The hybrid calling option allows for a **Site** to be selected, as well as a **Directory Number** that is available.

The **Mail ID** input is then generated, using:

`wt_ + <random-number> + the email hostname set up for the Webex Teams service, for example
wt_886821663180@myhost.com.`

A subscriber user for the device is then added at the selected site (**Site**), with:

- **User Id and Last Name:** `wt_886821663180`
- **First Name:** workspace **Name**
- **Primary Extension:** **Directory Number**
- **Phone:** Spark Remote device with workspace specific settings

Once the device code is entered, the VOSS-4-UC form also shows the details of the device associated with the workspace in the **Devices** group, for example: **Product**, **Connection Status** and **IP Address**. A link to the device is then also available, to show details (read only) as listed under the **Devices** menu for Webex Teams.

The added workspace is listed on the **Workspaces** menu.

20.15.7. Manual Steps

When workspaces are created or updated in VOSS-4-UC from the **Workspaces** menu, the data entered on this input form is formatted as a sequence of steps in an email message to be carried out on the Webex Teams Control Hub.

See:

- [Webex Teams Workspaces](#)
- [Global Settings](#) for an email message example.

The content of these manual steps for a workspace configuration can be seen as the **Steps** content of the instance from the **Manual Steps** menu.

20.15.8. Webex Teams Licenses

Webex Teams Feature Reference

This provides a condensed view of the Webex Teams Licenses consumed and available at the selected hierarchy level.

Click **Webex Teams > Licenses** to open the **Webex Teams Licenses** list view. The list view provides the following information:

- Name (of the license)
- Total Units (total number of licenses available)
- Consumed Units (the number of licenses still available)
- Location (where the licenses are available and used)

Webex Teams license usage counts aren't automatically updated in VOSS-4-UC after licenses are assigned (that is, after assigning a subscriber with Webex Teams services). For this reason, it is recommended that you create a schedule to periodically sync Webex Teams user licenses.

Webex Teams user license syncs may be actioned manually:

Admin Portal	To sync Webex Teams users for the customer, click the Services menu, then on the Customer Access form, click Action > Sync Webex Teams Roles Licenses . Go to (default menu) Administration Tools > Data Sync and run the <code>SyncSparkRolesLicenses<customer_name></code> instance.
Business Admin Portal	On the Webex Teams Quick Actions card at the customer hierarchy, select Sync Licenses .

Important: Webex Teams Licenses need to be synced after upgrading to release 21.1:

1. Execute the Data Sync named `SyncSparkRolesLicenses<CUSTOMER_NAME>`.
2. If the Webex Teams organization associated with the Customer hierarchy has multiple Subscriptions, a default Subscription must be configured under the Webex Teams Customer Access.
See: [Create Webex Teams Service](#).
3. If the Webex Teams organization associated with the Customer hierarchy has multiple Site URLs, a default Site URL must be configured under the Webex Teams Customer Access.
See: [Create Webex Teams Service](#).

Only licenses synced and managed by VOSS-4-UC will be assignable to a Webex User. This means that licenses from Subscriptions and Sites other than the default configured above will not be retained on a user.

Note: This process only collects data at customer and site levels.

20.16. Reassign Services

20.16.1. Reassign Services

High level feature workflow:

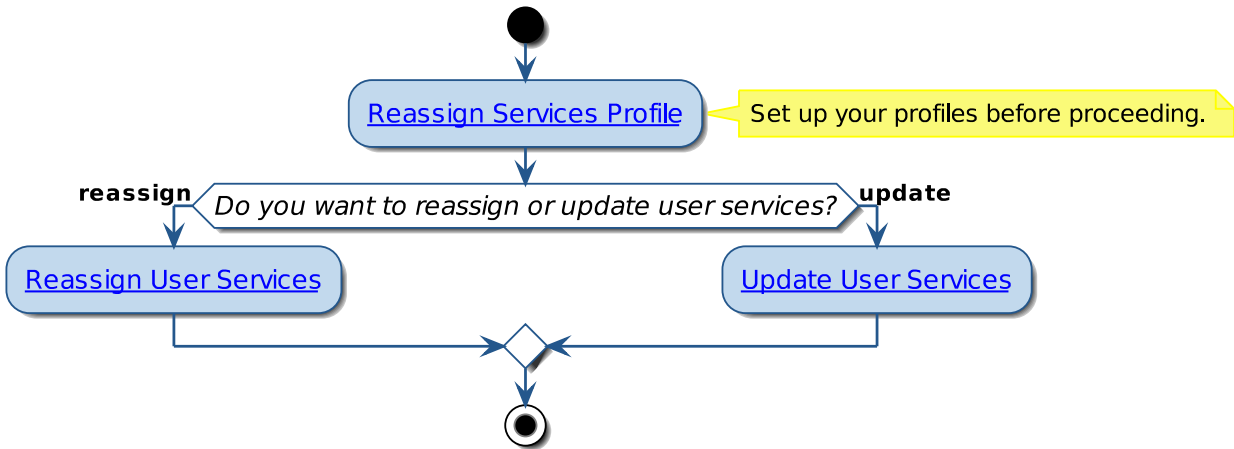

Documentation: [Reassign Services: Overview](#)

Reassign Services Profile

This is a set of configuration settings and additional settings to apply. If no CFT is defined for a service, it is still moved to the new user. However, existing settings will be left in place.

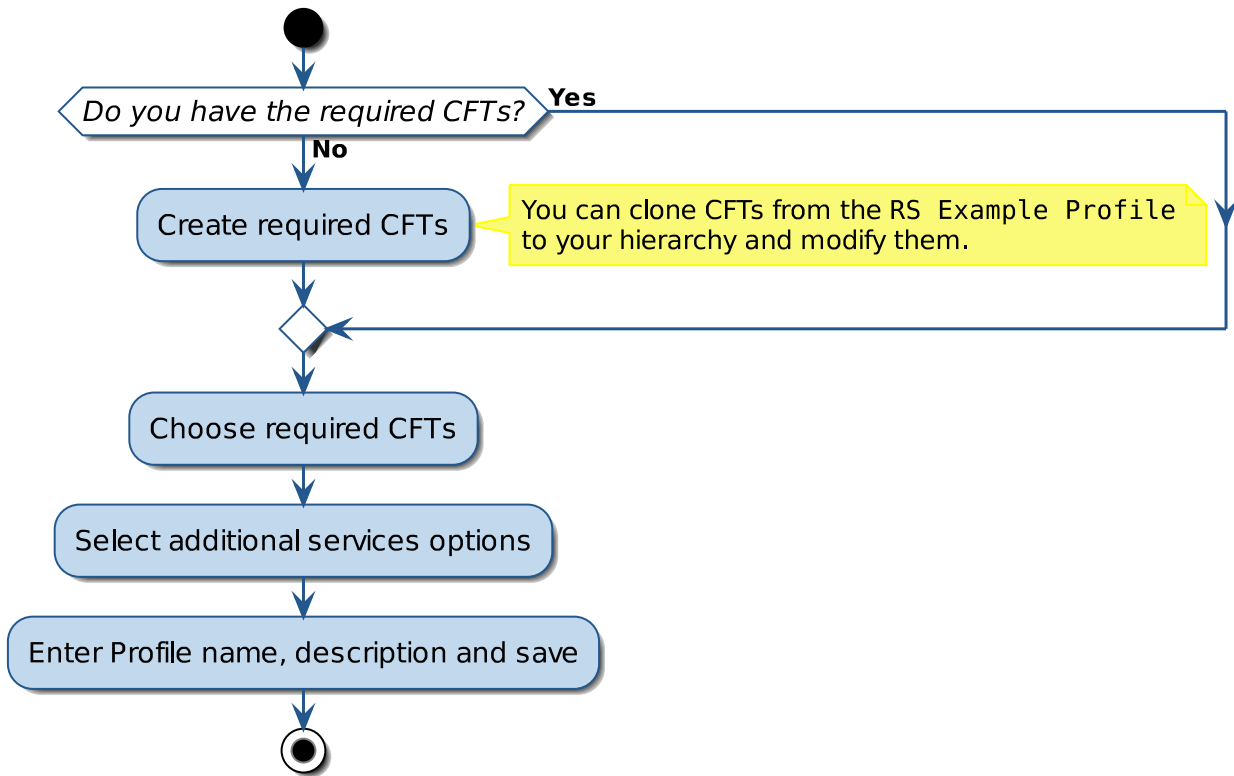



Documentation: *Reassign Services Profile*

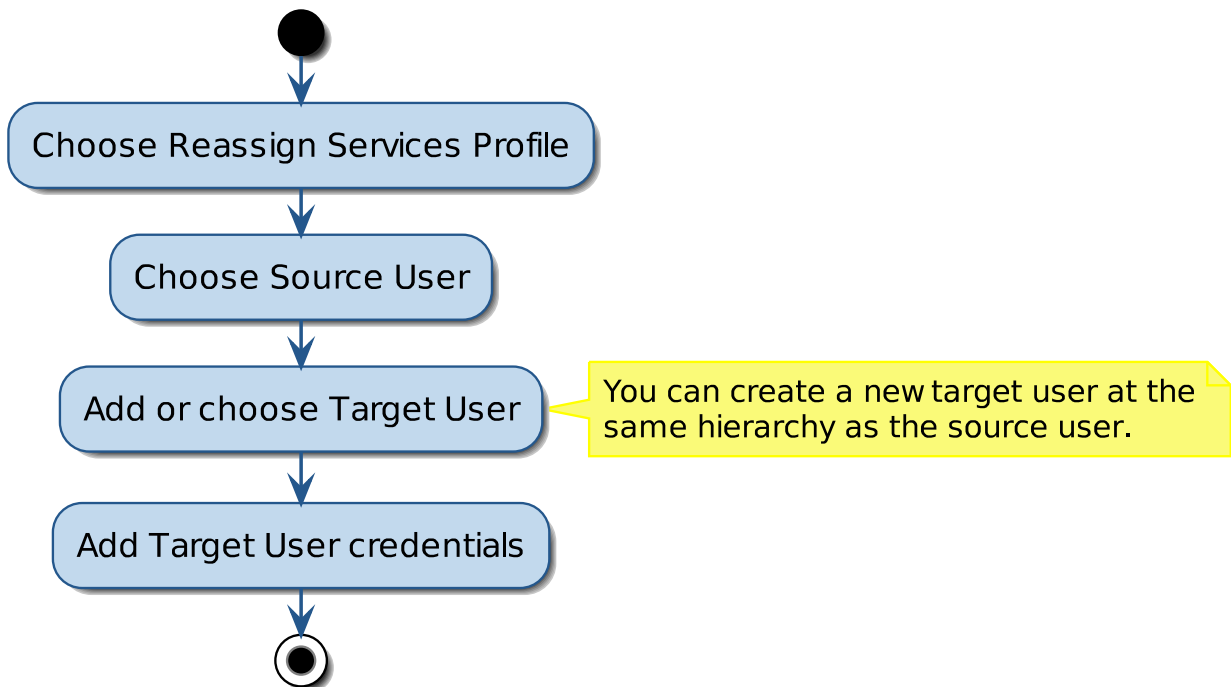

Reassign Services Profile

Reassign User Services



 Documentation: [Reassign Services](#)

 [Reassign User Services](#)

Update User Services

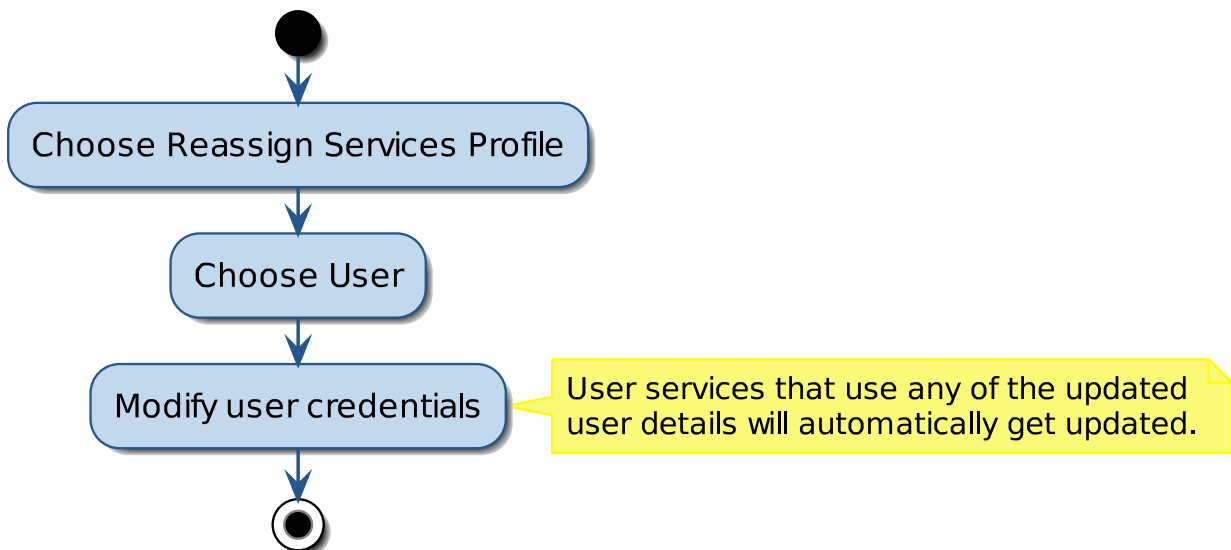

 Documentation: [Update User Details](#)



20.16.2. Reassign Services: Overview

Reassign Services simplifies and automates the transfer of existing Subscriber services from a Source User to a Target User.

This utility is for example useful when an employee left the company and a new employee now starts the same role. Therefore, instead removing the old subscriber and configuring a new subscriber with the same settings and standards, the services and settings can be moved from the old subscriber to the new subscriber.

These services can include:

- Phone(s), which can be dual-mode with associated Remote Destination and/or Mobile Identity
- Device Profile(s)
- Remote Destination Profile(s) with associated Remote Destinations
- Voicemail User with related services including Alternate Extension and Message Handler (Action).

Note: Webex (Meetings and Teams) and CCX services are not currently supported by this feature.

Custom settings can be applied to these services during the reassignment. A **Reassign Services Profile** setting is available to choose the configuration templates that will be used to update services during reassignment. These allow you to customize most settings on any of the above devices, including Line Alerting Name, Line Label, DisplayASCII values, and so on.

Example templates are provided that contain macro variables for fields that are likely to differ between subscribers. The field values then resolve with input from existing target user details. In this way the templates are not limited by for example a Site and Phone Model.

When reassigning services from existing source users to existing target users, the latter are moved to the *same site* as the source user, if these differ.

An option is also available to create a new target user as part of the Reassign Services process, instead of selecting an existing user without services. This user will be created at the same site as the source user.

Other features included are:

- Change User Details (modified Reassign Services) that updates the services of an existing subscriber using custom templates referenced in a Reassign Services Profile.

Related Topics

- [Reassign Services](#)
- [Update User Details](#)
- [Reassign Services Profile](#)

20.16.3. Reassign Services

The Reassign Service feature directs you to the Customer hierarchy (if you are not already there) because it supports target users that are on a different site as the source user.

Field Name	Comment
Reassign Service Profile	This field will pre-populate with the first profile. You can select a different profile if required. If no profile option is available, then a reassign service profile needs to be added in the system.
Source User	Choose the subscriber to be reassigned. This provides a list of usernames of Subscribers in the system. It will list local or CUCM-LDAP Synced Subscribers only (not VOSS-LDAP Synced). Once a subscriber is selected, the Source User Services tab is updated to show services currently assigned and that will be reassigned to the target user. This is a good way to validate that all the services are shown or that there are not services that you do not want reassigned.
Source User Hierarchy	Once a subscriber is selected the Source User Hierarchy will be populated - this is a read-only informational field.
Add A New Target User	Select this option if you need to add a new local user to the system as the target user. Once selected, the form updates to reflect this choice.
Target User	To reassign to an existing user: select the username from the drop-down. This will show local or CUCM-LDAP synced users at the customer level or lower. Once a user is selected, the Target User Services tab is updated to reflect any services currently assigned to the user. If the user has any entries on this tab then the transaction will be blocked. So this provides an option to check before submitting. To create a new target user: enter the username for the new user to be created. The user will be added to the same hierarchy as the source user.
Target User Hierarchy	Shown only if add new target user is not selected - read-only informational field. Shows the hierarchy of the selected target user. Can be different to the source user and the feature will move the target user to the same hierarchy as the selected source user.
First Name	First Name of the Target user. Will be read only if the target user is a LDAP synced user.
Last Name	Last Name of the Target user. Will be read only if the target user is a LDAP synced user.
Email Address	Email Address of the Target user. Will be read only if the target user is a LDAP synced user.
Password	Visible if the target user is not a LDAP synced user. Enter the password for the target user.
Pin	Enter the PIN for the target user (used for device profile and voice-mail).

Notes:

- The feature requires that source user services should all be at the same site hierarchy.

- Target user and hierarchy:
 - New target user - will be added to the hierarchy of the source user.
 - Existing target user - If the target user is in a different hierarchy to the source user, the target user will be moved to the same hierarchy as the source user as part of the reassign of services.

Note: It is not possible to reassign services to a user who is on a different Unified CM Cluster than the source user. The target user dropdown will currently not show users on a different cluster.

- The **Source User Services** tab will populate once a source user has been selected. This shows the services currently assigned to that user and the services that will be reassigned. This is a good way to validate the services that will be reassigned and to check if there are any services missing or that should not be reassigned. This can then be corrected as needed before reassigning the services.
- The **Target User Services** tabs will populate once a target user is populated. This is a good way to validate that the target user does not currently have any services assigned, as this will cause the transaction to fail with an error message indicating the target user has services. This can be resolved by choosing a different target user or by removing the services currently configured for the target user.
- Based on the setting in the reassign profile, the source user will either be left in the system (without any services) or removed from the system entirely.

Most of the services are updated to be associated to the target user and have settings updated according to the Configuration Templates (CFTs) in the reassign profiles.

There are some considerations:

- Single Number Reach (SNR) - Any existing remote destinations configured for the source user are deleted. The Remote Destination Profile (RDP) is then associated to the target user and updated per the CFT in the reassign services profile.
- Voicemail - the existing voicemail service for the source user is deleted to ensure a clean voicemail service. The voicemail service is then rebuilt for the target user based on the CFT in the reassign service profile. This means that any personalized settings, messages, greetings, and so on are cleared.
- Shared lines - Shared lines associated to the source user will only be updated if the shared line is the source user's primary extension.

The feature includes the optional ability to update shared line appearances of the source user's lines on other users' phones to reflect the destination user's details. For example:

- Bob.Smith has a phone with the following:
 - Line1: 55210 - Label: Bob Smith 55210
- Mary Smith has a phone with the following:
 - Line 1: 55220 - Label: Mary Smith 55220
 - Line 2: 55210 (shared line appear of Bob) - Label: Bob Smith 55210

In this case, when Bob's service is reassigned to a new user, Mary's Line 2 appearance will need to be updated to reflect the new user (e.g display name, label, etc.). This is supported for line appearances on Phones, Device Profiles, and Remote Destination Profiles. See the reassign services profiles section for more details on the controls.

20.16.4. Update User Details

The **Update User Details** menu shows a simplified form of Reassign Services where only one source user is selected, and that user's services are updated using custom Configuration Templates referenced in a Reassign Services Profile. The input fields allow for an easy update of basic details such as First Name, Last Name, Email, Password and PIN. User services that use any of the updated user details will automatically get updated.

The **Reassign Services Profile** drop-down list is available to select a profile to be used to also update the user's services details.

Similar to Reassign Services, selecting a Username auto-populates the Hierarchy of the selected user and the **Current User Services** tab shows which services will be updated.

20.16.5. Reassign Services Profile

The **Reassign Services Profile** input form allows for a set of configuration settings and additional settings to apply when the Reassign Services functionality is used. The configuration templates (CFTs) that are selected in the profile determine how many of the detailed settings of the various services are updated as part of the reassign. This is essentially to allow you to re-align settings to your baseline service deployment logic and update any settings that incorporate the user's name - for example descriptions, alerting/display names, labels, and so on.

If no CFT is defined for a service, it is still moved to the new user. However, existing settings will be left in place. There are a few cases where the feature will make updates to specific service settings regardless of the CFT (i.e. when these settings are required to associate the user and service - owner of a phone, associated devices on the UCM user, etc). If the source user does not have a given service (e.g voicemail) then any CFT in the profile is ignored as the feature does not add new services that did not exist on the source user.

There is a set of example CFTs in the system by default - prefixed `RS` - that provides some examples of common settings and logic that might be used.

This profile and templates for configuration settings can be maintained per hierarchy as needed. The context for the reassign services feature is fairly similar to Quick Add Subscriber and this is to allow the reuse of macros/logic from your quick add group CFTs in the reassign services profiles. In many cases you could even use the same CFT to ease maintaining multiple sets of CFTs that define the baseline user and service configuration.

Note: At least one Reassign Services Profile must be created in order to use the feature.

Field	Description
Profile Name	Name for the Profile - recommended to make it meaningful to the user's that will be using the feature if you need more than one profile.
Profile Description	Description for the profile
Remove Source User	If selected the feature will fully remove the source user after moving all the services. If not selected then the base user and subscriber will be left when the feature completes however no services will be enabled.
User CFT	This CFT defines VOSS User settings to apply to the target user - e.g. role
CUCM User CFT	This CFT defines the UCM User settings to apply for the target user - e.g. Department, Service Profile, etc.
Line CFT	This CFT defines the UCM Line settings to apply for the target user - e.g. Description, Alerting Name, Pickup Group, Call Forwarding, etc
Phone CFT	This CFT defines the Phone settings to apply to the devices being moved - e.g. Line Label, display name, device pool, CSS, etc. This same CFT applies to all phones (hardphones, soft-clients, etc) so typically relate to line appearance settings or other non-phone type specific settings. ownerID, mobility user (for soft clients) as set via the workflow irrespective of the CFT.
Device Profile CFT	This CFT defines the Device Profile (extension mobility) service for the user - e.g. Line label, display name, etc. As with the Phone this is typically for line appearance settings on the device profile.
Remote Destination Profile CFT	This CFT defines the Remote Destination Profile (Single Number Reach - SNR) settings to apply to the service being moved - e.g. line label, display name, CSSs, etc. Again typically for updating line appearance settings but can also edit other base RDP settings.
CUC User CFT	This CFT defines the CUC User (Voicemail) settings to apply when setting up voicemail for the user.
Add CUC User Alternate Extension	This setting determines if the feature will add a voicemail alternate extension for the user if voicemail exists on the source user. This can be used to add a standard alternate extension (e.g. short extension version of the user's number) if needed as part of your standard deployment.

Field	Description
CUC Alternate Extension CFT	This setting is visible if the add alternate extension setting above is true. This CFT determines the settings for the alternate extension that will be added. This is where you would define the alternate extension to be added as standard.
Update CUC User Message Handler (Action)	This setting determines if the feature will configure the message handler settings for voicemail (form of single inbox).
CUC Message Handler (Action) CFT	This setting is visible if the message handler setting above is true. This CFT determines the settings that will be configured for the message handler. So this will need to include the email address for example of the user as well as the message actions.
Update shared lines (for unassociated Phones, Device profiles, RDP)	This setting determines if the feature will update line appearances of the source user's lines on other user's devices. This can be used to update the display names or labels for instance on those remote devices to reflect the new user's details. These CFTs only apply to line appearance settings on those devices (not general phone settings) and only for the line appearances that are shared with the source user. Other line appearances on the devices will not be updated. For example, the other user's phone had 3 lines, only 1 of which was shared with the source user. Only that 1 line appearance will be updated and the other 2 will be left untouched.
Shared Line (unassociated Phone) CFT	This setting is visible if the Update Shared Line setting is true. This CFT determines the settings on the other users' Phones that have the line appearance.
Shared Line (unassociated Profile) CFT	This setting is visible if the Update Shared Line setting is true. This CFT determines the settings on the other users' Device Profiles that have the line appearance.
Shared Line (unassociated RDP) CFT	This setting is visible if the Update Shared Line setting is true. This CFT determines the settings on the other users' RDP that have the line appearance.

Typically, Configuration Templates similar to your current Quick Add Subscriber templates can be used. Example Configuration Templates are also available for each drop-down, with naming convention `RS Example <service> CFT`. The templates shown on the **Configuration Templates** menu can be cloned, renamed and modified per hierarchy as required.

Configuration examples:

- Template Name: `RS Example CUCMPhone CFT`

Field: **Line > Display Ascii**

Value:

```
((input.firstName == fn.null ))
<{{input.lastName}}>
<{{input.firstName}} {{input.lastName}}>
```

- Template Name: `RS Example CUCMLine CFT`

Field: **ASCII Alerting Name**

Value:

```
{{fn.sub_string input.lastName, 0, 30}}
```

Additional optional settings available:

- **Add CUC User Alternate Extension:**

If checked, a drop-down is enabled to select a template that updates the alternate extension.

Example template: RS Example CUCAlternateExtension CFT

Field: **DisplayName**

Value:

```
{{ input.firstName }} {{ input.lastName }} Alt
```

- **Update CUC User Message Handler (Action):**

If checked, a drop-down is enabled to select a template that updates the email address for single inbox.

Example template: RS Example CUCMessageHandler CFT

Field: **RelayAddress**

Value: if no input email address is available, a dummy address is added

- **Update shared lines (for unassociated Phones, Device profiles, RDP):**

If checked, a drop-down is enabled to select a template so that for any shared line instances from the source user, line label details can optionally be updated with those of the target user. The **Line CFT** template updates do not apply to shared lines.

20.17. PLAR (Hotdial)

20.17.1. PLAR (Hotdial): Overview

The Private Line Automatic Ringdown (PLAR) feature, also called Hotdial, automates the Unified CM configuration required to set up PLAR for a phone. The PLAR feature provides an administrator with a single interface and workflow for the management of the following elements of Unified CM:

- RoutePartition
- CSS
- TransPattern
- Phone
- Line
- SIP Dial Rule

The feature further provides an administrator with:

- A simplified user interface to select a Phone that must be enabled for PLAR, a destination number, and the destination CSS.
- The orchestration of a workflow to create the necessary Unified CM partition, CSS, Translation Pattern, and so on, and to apply these to the relevant Phone and Number.

To configure an existing phone for Hotdial, the user selects a pre-existing device and indicates that the device is a Hotdial device.

As soon as a PLAR configured phone goes off hook (or the NewCall softkey or line key gets pressed), the phone immediately dials a pre-configured destination number. The phone cannot dial any other number except the Hotdial destination that gets configured for PLAR.

The PLAR configuration can be added or deleted, but not modified.

20.17.2. PLAR (Hotdial) Workflows

When adding a new Hotdial Phone (PLAR configuration), the following workflow is executed:

1. A Unified CM route partition is created with:
 - a. Name set to the Hotdial Phone selected, prefixed with "HotdialPT-". For example: "HotdialPT-SEP000000000000".
2. A Unified CM CSS is created with:
 - a. Name set to the Hotdial Phone selected, prefixed with "HotdialCSS-". For example: "HotdialPT-CSS000000000000".
 - b. The Partition created above is made a member of the CSS.
3. A Unified CM translation pattern is created with:
 - a. Partition name is set to the Partition added, prefixed with "HotdialPT-", for example: "HotdialPT-SEP000000000000".
 - b. Calling Search Space Name set to the selected Destination Dialing CSS.
 - c. Called Party Transformation Mask is set to the selected Hotdial Destination Pattern.
 - d. Route Option is set to Route this pattern.
 - e. Urgent Priority is enabled.
4. The Unified CM phone selected is updated as follows:
 - a. For SIP Phones only, a SIP Dial rule is created and the phone is set to use the SIP Dial Rule.
 - b. CSS name is set to the "HotdialCSS-" added for the Phone.
 - c. Hotline Device is set to true if the phone is marked as a Hotline Device by the user on the input form.

VOSS-4-UC automatically resets the phone when required.

When deleting PLAR (Hotdial) for a Phone (deleting the PLAR configuration), the following workflow is executed:

1. Update Phone CSS to the original CSS.
2. Delete the Hotdial Translation pattern.
3. Delete the Hotdial CSS.
4. Delete the Hotdial Route Partition.
5. For SIP Phones only, the device is updated to use a Dial Rule of "None", and the Dial Rule is deleted.

20.18. Hunt Groups

20.18.1. Hunt Group Management

Hunt groups can be configured at the customer or site level.

The purpose of hunt group management is to provide business context for the lines selected as members of line groups and to provide you with a single consolidated view of the following hunting elements.

- Hunt Pilot
- Hunt List
- Line Groups

Note: When selecting a Call Pickup Group from the drop-down list, the available Call Pickup groups to choose from will be:

- those at the hierarchy of the current Hunt Group if there are any available
- those at a hierarchy level above the current if none are available at the current level

You must select the lines that belong to line groups or any existing line groups that must be added to the hunt list members.

For hunt groups configured at the customer level:

- You are prompted for an NDL that identifies the Cisco Unified CM where the hunt group is defined.
- You can define a unique hunt pilot pattern for the hunt group. The hunt pilot pattern is added to the customer-level DN inventory and is marked as in-use and unavailable.
- You can include lines defined at the customer level and at any site within the customer.

Searches can be performed on any of the details of the hunt pilot.

A hunt group is a combination of the hunt pilot, hunt list, and line groups that are automatically linked together using unique identifiers for the following:

- The hunt pilot's hunt list is set to the name of the hunt list. The hunt list name must be configured first in order for it to appear in the hunt pilot tab.
- The hunt list's line group members are set to the name of the associated line groups.

Certain default values for hunt groups are populated by the site defaults menu item, which can be viewed and edited (depending on your log-in level). See the **Default CUCM Hunt Pilot Partition** field on the **General Defaults** tab under the **Modify Site Defaults** topic in this manual.

Hunt groups can be:

- **Added** - You can specify the parameters of the hunt pilot and the hunt list, and select one or more new or pre-existing line groups from a drop-down or free text field. If your administrator has enabled the number inventory feature, you can select the **Hunt Pilot Pattern** from a drop-down list of available numbers. If the feature is disabled, the **Hunt Pilot Pattern** field is a free text field or a drop-down containing only selected available numbers. To allow the successful use of call forwarding in a hunt pilot, the defaults for Max Callers In Queue (32) and Max Wait Time In Queue (900) are cleared. To use queuing instead of call forwarding, set these values other than the default, for example to 33 and 901.

- **Modified** - You can modify the parameters of the hunt pilot or hunt list. Examples include adding or deleting line groups, or adding or deleting line group members.
- **Deleted** - You can delete a hunt group.

20.18.2. Add a Hunt Group

Use this procedure to add a hunt group in VOSS-4-UC and Cisco Unified Call Manager (CUCM).

1. Log in as site administrator or higher.
2. Browse to the hierarchy level (if necessary) to which you want to add the hunt group.
3. Click **Subscriber Management > Hunt Groups**. The **Hunt Groups** list is displayed.
4. Click **Add**.
5. Complete, at minimum, the required fields on each tab (see below).
6. Click **Save**

Hunt Pilot

A hunt pilot comprises a string of digits (an address) and a set of associated digit manipulations that route calls to a hunt list. Hunt pilots provide flexibility in network design. They work in conjunction with route filters and hunt lists to direct calls to specific devices and to include, exclude, or modify specific digit patterns.

- **Hunt Pilot Pattern** - Enter, or select from the drop-down list, the hunt pilot pattern, including numbers and wildcards (do not use spaces); for example, for NANP, enter 9.@ for typical local access, or 8XXX for a typical private network numbering plan. Valid characters include the uppercase characters A, B, C, and D and +, which represents the international escape character +. Make sure that the directory hunt pilot, which uses the chosen partition, route filter, and numbering plan combination, is unique.
- **Route Partition** - If you want to use a partition to restrict access to the hunt pilot, choose the desired partition from the drop-down list. If you do not want to restrict access to the hunt pilot, do not choose a partition, i.e leave the field blank.
- **Numbering Plan** - Choose from the drop-down list.
- **Route Filter** - If your hunt pilot includes the '@' wildcard, you may choose a route filter from the drop-down list. The optional act of choosing a route filter restricts certain number patterns. The route filters that display depend on the numbering plan that you choose from the Numbering Plan drop-down list.
- **Hunt List** - The hunt list name must be configured first on the **Hunt List** tab in order for it to appear on this tab. See **Hunt List** below for details.
- **Call Pickup Group** - Choose the number that can be dialed to answer calls to this directory number (in the specified partition).
- **Alerting Name** - Enter an alerting name for the hunt pilot in UNICODE format. This name gets displayed on phones that the hunt pilot dials when it receives an incoming call, along with calling party information. The phone users can use this information to answer the call accordingly. This name also gets displayed on the calling phone. If you do not enter a name, the hunt pilot DN displays on the phones.
- **Provide Outside Dial Plan** - Select this check box for each hunt pilot that routes the call off the local network and provides outside dial tone to the calling device. Leave the check box clear if you want to route the call in the network.

- **Maximum Hunt Timer** - Specifies the maximum time for hunting without queueing. **Do not specify the same value** for the **Maximum Hunt Timer** field and the **RNA Reversion Timeout** field on the associated line group.
- Enter/complete the required fields under the **Forward Hunt No Answer**, **Forward Hunt Busy**, **Queueing** and **Park Monitoring** areas of the page:
 - The **Forward Hunt No Answer Action** and **Forward Hunt Busy Action** drop down lists offer respective Hunt Call treatment settings.

An option is available not to forward hunt calls, but if the selected option is to specify the calling search space and destination, the respective CSS and Destination input boxes are enabled to allow for data input. **CFNA Destination** and **CFB Destination** indicate the directory number to which calls are forwarded. **CSS CFNA** and **CSS CFB** apply to all devices that are using this directory number. Drop-down displays all the CSSs in the system. Default = Default line CSS of the site.

When the drop down option **Use Forward Settings of Device that Forwarded to Hunt Pilot** is selected, the call forward settings of the line group member are used.
 - If under the **Queueing** group you select the **Queue Calls** check box, the Forward Hunt Groups are disabled. Fields are enabled for input and mandatory fields take default values:
 - * **Maximum Number of Callers Allowed in Queue:** 32
 - * **Maximum Wait Time in Queue:** 900

Hunt List

A Hunt List lists a set of Line groups in a specific order. A hunt list then associates with one or more hunt pilots and determines the order in which those line groups are accessed. The order controls the progress of the search for available directory numbers for incoming calls. A hunt list comprises a collection of directory numbers as defined by line groups.

A hunt list can contain only line groups. Each hunt list should have at least one line group. Each line group includes at least one directory number. A single line group can appear in multiple hunt lists.

- **Name** - The name can comprise up to 50 alphanumeric characters and can contain any combination of spaces, periods (.), hyphens (-), and underscore characters (_). Make sure each hunt list name is unique to the route plan.

Best practice is to use concise and descriptive names for your hunt lists. The CompanynameLocationCalltype format provides enough detail and is short enough so you can easily identify a hunt list.
- **Cisco Unified Communications Manager Group** - Choose a CUCM group from the drop-down list. The hunt list registers to the first node in the CUCM group.

If you choose a CUCM group that has only one node that is configured, you receive a warning. To avoid this issue, choose a group that is configured with more than one node.
- **Enable this Hunt List** - Select this check box to enable your hunt list immediately when you click **Save**. No system reset is required.
- **For Voice Mail Usage** - If this hunt list is to be used for voicemail, select this check box. If you select this check box, the route list control process keeps a count of the setups that are being served to the hunt list, and will not allow more setups than the number of available devices. As a result, each device in the hunt list is treated as if it has a Busy Trigger and related Maximum Number of Calls of one.

Line Groups

A line group allows you to designate the order in which directory numbers are chosen. CUCM distributes a call to idle or available members of a line group based on a call distribution algorithm and on the Ring No Answer (RNA) Reversion Timeout setting.

Note: Although you can configure an empty line group with no members (directory numbers), CUCM does not support this configuration for routing calls. If the line group contains no members, the hunt list stops hunting when the call gets routed to the empty line group. To avoid this, make sure that you configure at least one member in the line group.

You must define one or more directory number before configuring a line group. After you configure or update a line group, you can add or remove members from that line group.

- **Line Group Name** - This field is a drop-down list, which allows you to choose an existing line group. The drop-down list displays all existing line groups available at the site.

This field can also be used as a free text field. To create a new line group, enter a name in this field.

The name can comprise up to 50 alphanumeric characters and can contain any combination of spaces, periods (.), hyphens (-), and underscore characters (_). Make sure that each line group name is unique to the route plan.

Best practice is to use concise and descriptive names for your line groups. The CompanynameLocationGroup format usually provides a sufficient level of detail and is short enough to enable you to quickly and easily identify a line group.

- **RNA Reversion Timeout** - Enter a time, in seconds, after which CUCM will distribute a call to the next available or idle member of this line group or to the next line group if the call is not answered and if the first hunt option, Try next member; then, try next group in Hunt List, is chosen. The RNA Reversion Timeout applies at the line-group level to all members.
- **Hunt Options No Answer** - Choose a hunt option for CUCM to use if a call is distributed to a member of a line group that does not answer. This option gets applied at the member level. Choose from the options in the drop-down list.
- **Automatically Logout Hunt Member on No Answer** - If this check box is selected, line members will be logged off the hunt list automatically. Line members can log back in using the "HLOG" softkey or PLK.
- **Hunt Options Busy** - Choose a hunt option for CUCM to use if a call is distributed to a member of a line group that is busy. Choose from the options in the drop-down list.
- **Hunt Options Not Available** - Choose a hunt option for CUCM to use if a call is distributed to a member of a line group that is not available. The Not Available condition occurs when none of the phones that are associated with the DN in question is registered. Not Available also occurs when extension mobility is in use and the DN/user is not logged in. Choose from the options in the drop-down list.
- **Member** - Configure Line Group Members as required by choosing a **Directory Number** and **Partition** from the drop-down list.

20.18.3. Hunt Group Management Workflows

When adding a new hunt group, the following workflow is executed:

- A hunt list is added with the details input by the user.
- A hunt pilot is added with the details input by the user.
- One or more line groups are created with the specified directory numbers as members.

When modifying a hunt group, the following workflow is executed (depending on what was modified):

- The line group details are modified.
- Added line groups are added.

A removed line group is deleted *only* if it is the last instance. If a shared line group is removed, it is deleted from the specified hunt group *only*, but is still included in other hunt groups that are also using it.

If the hunt group uses existing line groups, then the existing line groups are updated when the hunt group is modified.

- The hunt list is modified.
- The hunt pilot is modified.

When deleting a hunt group, the following workflow is executed:

- The line groups that are members of the hunt list are deleted (if they are not used by any other hunt group in the system).

If a shared line group is removed, it is deleted from the specified hunt group *only*, but is still included in other hunt groups that are also using it.

- The hunt pilot is deleted.
- The hunt list is deleted.

20.19. Call Pickup Groups

20.19.1. Call Pickup Groups: Overview

Certain default values for call pickup groups are populated by the site defaults menu item, which can be viewed and edited (depending on your log in level). Choose **Dialplan Management > Site Defaults** and click on the required site name in the list view.

The Call Pickup Groups feature provides an administrator with the following:

- A single interface on which to create call pickup groups, and to select one or more lines as members of a pickup group.
- The ability to add Unified CM call pickup groups and to modify the call forward and call pickup settings of each Unified CM directory number for membership to a newly added call pickup group. When adding a call pickup group, if your administrator has enabled the number inventory feature, the Pattern can be selected from a drop-down list of available numbers. If the feature is disabled, the **Pattern** field is a free text field or a drop-down containing only selected available numbers.

- The ability to add lines to an existing call pickup group by selecting the pattern (directory number). When adding a member line, if your administrator has enabled the number inventory feature, the Pattern can be selected from a drop-down list of available numbers. If the feature is disabled, the **Pattern** field is a free text field or a drop-down containing only selected available numbers. The **Route Partition Name** field is populated automatically based on the selected Pattern.
- The ability to delete a pre-existing call pickup group, and to delete one or more lines from an existing call pickup group.

The first member of the associated pickup group name is set the newly created pickup group, and associated pickup groups can be added as part of the workflow.

20.19.2. Add a Call Pickup Group

Use this procedure to add a call pickup group in VOSS-4-UC.

1. Log in as provider, reseller, customer, or site administrator.
2. Set the hierarchy to the Customer or Site level.
3. Choose the Network Device List only if you have set the hierarchy to Customer level. For Site level this step is not required.
4. Choose **Subscriber Management > Call Pickup Groups**.
5. Click **Add** on the button bar to open the **Call Pickup Groups** input form.
6. On the **Call Pickup Group** tab, enter the **Name** and a **Description**.
7. From the **Call Pickup Group Number** drop-down, choose the pickup group pilot number.
8. From the **Route Partition Name** drop-down, choose the required route partition.
9. From the **Pickup Notification** drop-down, choose the method (**No Alert**, **Audio Alert**, **Visual Alert** or **Audio and Visual Alert**, and then enter the required **Pickup Notification Timer** period (in seconds).
10. If the Call Pickup Group is associated with other pickup groups, click the + next to **Call Pickup Groups** to expose the **Pickup Group Name**. This allows users to pick up incoming calls in a group that is associated with their own group.

Note that the first member is automatically added, so there is no need to specify the first member as itself in an Add request.

- a. For included **Pickup Group Names**, ensure that the **Priority** always starts at 1. When more than one included group exists, the group with Priority 1 has the highest the priority of answering calls for the associated group. Integer values are added in order of priority.
 - b. The associated Directory Name and Partition is automatically selected, based on the Call Pickup Group Name.
 - c. Set any required Pickup Notification settings.
11. On the **Member Lines** tab, click the + (Add) button next to **Line** to expose the Line section.
 12. Choose a **Directory Number** from the drop-down. The **Route Partition** Name is automatically selected, choose a different **Route Partition** if necessary. Call Pickup Group members will only be successfully added if their directory number exists in a valid route partition. Directory numbers in a 'null' route partition, appear as selectable members, but saving them results in an error.
 13. Repeat steps 11 and 12 to add more members to the **Call Pickup Group**.
 14. Click **Save** on the button bar when complete to save the **Call Pickup Group**.

Note: If you are using partitions with the call pickup numbers, ensure that the directory numbers that are assigned to the call pickup group have a Calling Search Space that includes the appropriate partitions. We recommend using `CU{macro}-PreISR-PT` partition for the call pickup groups added at the customer hierarchy.

The selected Call Pickup Groups drop-down lists the call pickup groups created at the customer and the site level. Select the required call pickup group from both the customer and the site level.

Adding a Call Pickup Group at customer level with members across child sites, succeeds without error, and the configuration is pushed to the associated Unified CM. However, when viewing the Call Pickup Group configuration after it was added, the added members will not be seen. Added members are only seen if the Call Pickup Group and its members are at the same hierarchy level.

Verify the individual Member Line association with the Call Pickup Groups by navigating to **Subscriber Management > Lines**. The Call Pickup Group under Lines displays associated Call Pickup Group.

20.19.3. Delete a Call Pickup Group

Use this procedure to delete a call pickup group in VOSS-4-UC.

1. Log in as provider, reseller, customer, or site administrator.
2. Set the hierarchy to the Customer or Site level.
3. Choose **Subscriber Management > Call Pickup Groups**.
4. Choose the call pickup group, and then click **Delete**.

20.20. Contact Center

20.20.1. Contact Center Management

The Cisco Contact Center Express (CCX) feature in VOSS-4-UC allows administrators to manage Agents and related configuration from a single pane of glass.

In addition to managing these configuration elements directly, the VOSS-4-UC Day 2 features also provide seamless CCX management.

As a part of Contact Center management, VOSS-4-UC provides a number of interfaces. The associated Contact Center device models that will also be synced to the Contact Center server (CCX device) upon a data sync.

- CCX Server Management:
 - *Contact Center Servers*
- Day 2 Integration:
 - When a CCX device has been added to a hierarchy and Entitlement Profiles have been added that have Contact Center entitlement enabled, subscribers can be configured as Contact Center Agents.

Further management can be carried out in VOSS-4-UC, including VOSS-4-UC Overbuild (*Objects that are Moved During the Overbuild*).

- [Contact Center Agent Quick Add](#)
- [Add Subscribers \(Contact Center\)](#)
- Direct Management:
 - **Agents** (device/uccx/Agent): see [Agents](#).
 - **Skills**: these are associated with competency levels - see [Skills](#).
 - **Teams** (device/uccx/Team): see [Teams](#).
 - **Resource Group** (device/uccx/ResourceGroup): see [Resource Groups](#).
 - **Contact Service Queues** (device/uccx/ContactServiceQueue): see [Contact Service Queues](#).
- Agent Device association with Unified CM Application users

Administrators can specify the agent's controlled device via:

 - Quick Add Subscriber
 - Subscriber
 - Direct Agent management

The device is associated with the list of Unified CM application users specified as part of the CCX server configuration.

Care is taken to keep this association in sync when Phones and Extension Mobility profiles are deleted or replaced.
- VOSS-4-UC also provides a number of interfaces to simplify Contact Center management:
 - **Agent Profiles**: see [Agent Profiles](#).
 - **Re-skilling**: VOSS-4-UC provides functionality so that skills and their competency levels can easily be managed in bulk (add, remove) by means of a set of side-by-side transfer boxes that are available for:
 - * Agents
 - * Teams
 - * Resource Groups

See: [Re-skill Contact Center Agents](#)

Agents

Agents that have been synced in or added when adding subscribers at a specific customer or site hierarchy are listed here.

The detail view of an Agent opened from the list also shows the Agent's devices and tagged lines.

Synced agents from CCX that have not been moved to a site may show the agent to be at the Customer hierarchy level.

It is possible to manage agents directly. An agent can also be added: choose **User ID** from the drop down.

The following agent properties can easily be managed from a single interface:

- **Alias**: agent alias on the device - note there are restrictions on allowable characters in the alias.
- **Type**: agent type: Agent or Supervisor

- **Team:** agents who are not assigned to a specific team, belong to the Default team.
- **Resource Group:** not mandatory; groups can be created
- **Automatically Available:** A check box enabled by default. If enabled, the agent is automatically in an available or ready state after finishing a call and disconnecting.
- **Skills:** not mandatory; skills can be defined.
- **Controlled Device:** select the agent's device type: either Extension Mobility or Phone. If Phone is selected, the phone needs to be selected from **Phone Name**.

Teams

Contact Center Agent Team names, their primary and secondary supervisors, team members and team availability to Contact Service Queues can be defined and managed by a set of side-by-side transfer boxes on the user interface.

It is possible to manage Teams at a customer level. When creating a new team at the customer level, the user must select a Network Device List.

Resource Groups

A list of Resource Groups can be defined that will comprise of one or more Agent Profiles. When creating these directly in VOSS-4-UC, they should therefore be defined *before* Agent Profiles are created.

When the Agent Profiles are created or maintained, the Resource Groups are referenced.

Also, when a Contact Service Queue can be configured to use Resource Groups.

Skills

A list of skills can be defined and competency levels are assigned to a selected skill when it is applied to an Agent, Agent Profile or a Skill Group in a Contact Service Queue.

Contact Service Queues

Incoming contact center calls are placed in the queue and sent to a specific agent in accordance with the specific queue configuration.

The Contact Service Queues (CSQs) interface allows for the properties of the configuration to be defined, for example associating Resource Groups or Skills.

If Voice, Chat and Email types of Contact Service Queues exist on CCX, data from these are included when a Contact Center server is imported. The queue types can then be managed.

Note: When a **Queue Type** is EMAIL, then the **Email Username** (`accountUserId`) and **Email Password** (`accountPassword`) fields are exposed on the input form and are mandatory.

Agent Profiles

An Agent Profile comprises of a:

- Team
- Resource Group: profiles can be grouped together as Resource Groups.
- Skill

These should therefore be defined *before* creating an Agent Profile.

Note: Agent Profiles should be created *before* creating an Agent using Quick Add Subscriber.

Re-skill Contact Center Agents

As a part of Contact Center agent management, re-skill menu items are available with access to user interface controls such as side-by-side transfer boxes or drop down lists.

These controls provide functionality to easily re-skill a selected number of contact center agents:

- By Agent: for selected skills and their selected competency levels, these can be added or removed for one or more agents.
- By Team: for a selected team, skills and their selected competency levels can be added or removed - thereby updating the team skills. (not for Business Admin Portal)
- By Resource Group: for a selected resource group, skills and their selected competency levels can be added or removed - thereby updating the resource group. (not for Business Admin Portal)

Example Setup Journey

1. Configure Unified CM and CCX server integration (this is done directly on the UC apps).
2. Create a new CCX server at the relevant customer hierarchy level:
 - a. Use CCX admin user credentials
 - b. Pick the list of Unified CM application users to be used for agent device association.
3. Update the Network Device List (NDL):
 - a. The relevant Unified CM and CCX servers must be referenced in the NDL.
 - b. This NDL must be set for each site hierarchy where agents will be managed.
4. Sync the existing configuration from the CCX server.

This can be done either directly from the CCX server page or via the **Data Sync** menu.
5. Create Agent Profiles under the **Contact Center** menu (usually under **Subscriber Management**).
6. Create a new Agent:
 - a. Using Quick Add Subscriber
 - b. Using Subscriber feature
 - c. Directly using the Agent feature under the **Contact Center** menu (usually under **Subscriber Management**).

21. Microsoft Subscriber Management

21.1. Microsoft Overview

VOSS-4-UC provides a management interface for managing Microsoft users and services, either as a stand-alone, Microsoft-only implementation, or as part of a multi-vendor implementation.

The flowchart provides a high level workflow for the Microsoft solution in VOSS-4-UC. Detailed workflows for each step are indicated.

Microsoft Overview Flowchart

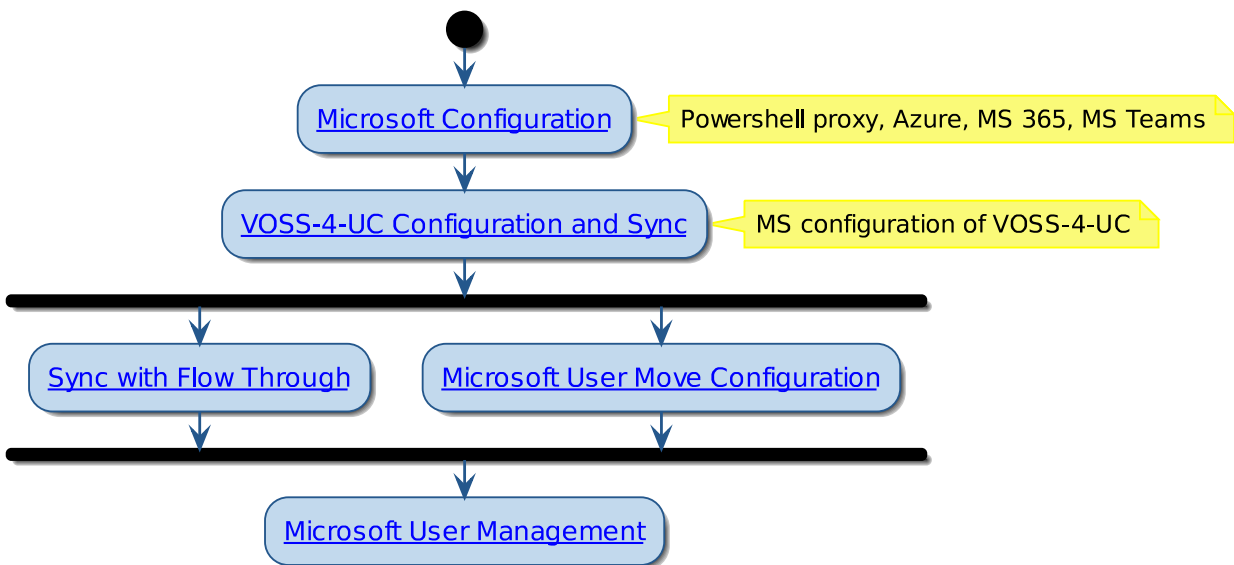

Related Topics

- *Microsoft Configuration*
- *Configure Microsoft Tenant on VOSS-4-UC*
- *Microsoft Licenses*
- *Introduction to Microsoft Teams Dialplan Management*
- *Configure Microsoft Tenant Dialplan*

- *Introduction to Microsoft Teams Policies*
- *Overbuild for Microsoft*
- *Model Filter Criteria*
- *Flow Through Provisioning Criteria*

21.2. Microsoft Configuration

An organization using Microsoft to manage UC provisioning requires at least three different portals in a tenant: Azure, Microsoft 365 Admin Center, and (once users are licensed through Microsoft Office 365), a portal on the Microsoft Teams side for telephony.

VOSS-4-UC combines these functions into a single management interface, allowing service providers to import data from multiple Microsoft tenants and to manage these customers (or tenants) from a single portal and login.

The diagram describes the initial configuration required to integrate Microsoft with VOSS-4-UC:

- You will need to install and configure a Microsoft Windows PowerShell Proxy server (one or more). This is to allow VOSS-4-UC to access Azure via the PowerShell. For details, see: [Microsoft Windows PowerShell Proxy Server Installation and Upgrade Guide \(Microsoft Teams\)](#)
- Once the Microsoft Windows PowerShell service is installed, you will use the IP address and credentials of the proxy server to configure the Microsoft tenant.

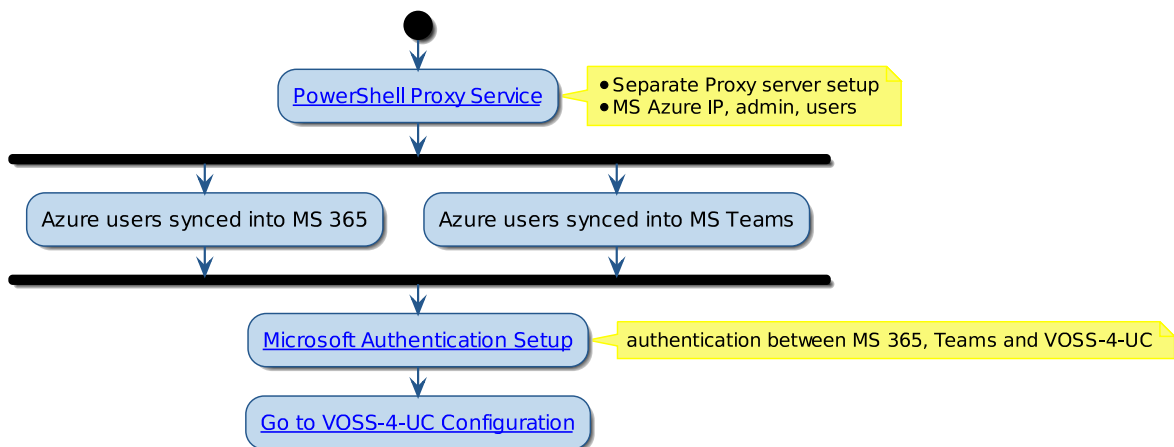

21.2.1. Next Steps

VOSS-4-UC Configuration and Sync in the Core Feature Guide

21.2.2. Related Topics

Microsoft Overview in the Core Feature Guide

21.3. Onboard and Offboard Microsoft Users

Onboarding a Microsoft user involves importing users and related data to the customer level from the Microsoft Cloud service, and then moving users to the correct sites as fully provisioned subscribers.

Automated workflows configure imported objects once changes are synced in, and apply the required configuration, policies, and licenses. This means administrators won't need to continually monitor the sync, or to perform additional steps to complete the process.

Once synced in (at the customer or site level), administrators can manage Microsoft users and subscribers via a single interface and login, from within the VOSS-4-UC Admin Portal. To maintain data integrity, to manage licenses, and to automate number auditing for synced in users, regular, targeted backend syncs poll for changes made at the device model layer.

21.3.1. Onboard Microsoft Users

VOSS-4-UC provides two onboarding options for Microsoft users:

Sync users to customer level, and then to sites	<p><i>VOSS-4-UC Configuration and Sync</i></p> <p>This option starts with an initial import of dial plans, policies, licenses, and Microsoft users, to the customer level (sync all to the tenant). Then you will need to set up the configuration and user move criteria before moving users to the sites (set up model filter criteria, site defaults, quick add groups, subscriber profiles, and number inventory). Finally, you have two options to move users to the sites as fully provisioned subscribers:</p> <ul style="list-style-type: none"> • Run the overbuild to move multiple users to your sites at once. • Add single users via Quick Add Subscriber (QAS) <p>When moving users to site, the VOSS-4-UC automated workflow applies the required configuration, services, lines, policies, and licenses.</p>
Sync users directly to sites	<p><i>Sync with Flow Through</i></p> <p>In this option, you run the initial sync together with flow through provisioning. In this case, you start by setting up the configuration and user move criteria before running the initial sync. That is, to set up the model filter criteria, site defaults, quick add groups, and subscriber profiles.</p> <p>In addition, you will need to:</p> <ul style="list-style-type: none"> • Configure flow through provisioning criteria • Enable flow through in the Global Settings <p>Once changes are synced in from the Microsoft Cloud, VOSS-4-UC automated workflows move the tenant dial plan, policies, and licenses to the customer level, and moves users directly to the appropriate sites as fully provisioned subscribers.</p>

21.3.2. Offboard a User

This procedure offboards a user.

1. Log in to the Admin Portal.
2. Go to **MS Subscriber Management > Subscribers**.
3. Click on the relevant subscriber.
4. On the **MS Licenses** tab, delete the licenses.

21.3.3. Related Topics

- Microsoft Overview in the Core Feature Guide
- VOSS-4-UC Configuration and Sync in the Core Feature Guide
- Sync with Flow Through in the Core Feature Guide

21.4. Microsoft Licenses

Microsoft license data is synced in to VOSS-4-UC from the Microsoft cloud, and are specified in the quick add group (QAG) configuration templates as part of the provisioning workflow.

Users are placed in staging (an unsaved state) while the license data is synced in to VOSS-4-UC. A licensed user may be assigned with the Enterprise Voice service in VOSS-4-UC, and is given an available number.

Note: To view staged users, go to (default menu) **Subscriber Management > Subscriber Staging**.

Targeted syncs may be scheduled from VOSS-4-UC to poll the Microsoft cloud for changes at regular intervals. Users are automatically provisioned in VOSS-4-UC, based on their service profiles and assigned licenses. The sync process moves Microsoft users to appropriate sites with the correct configuration, based on the site defaults, filter criteria, and user service profiles. The number assigned to the user is added to a number inventory in VOSS-4-UC, and is flagged with the user's name.

View Microsoft Licenses by Customer

To view all Microsoft licenses synced currently synced in to VOSS-4-UC, go to (default menu) **Subscriber Management > Licenses**. The Licenses summary list view provides the following license details per customer:

- SKU ID
- Number of active licenses
- Number of used licenses
- Customer name

View a Subscriber's Microsoft Licenses

To view the license details of individual subscribers via the Subscriber management functionality:

1. Go to (default menu) **Subscriber Management > Subscribers**.
2. Click on a subscriber to open the Subscribers [subscriber name] page.
3. Select the **MS Licenses** tab.
4. View currently enabled licenses for the subscriber.

Offboarding Users and Licensing

Offboarding a user in VOSS-4-UC simply involves removing the user's licenses. See *Onboard and Offboard Microsoft Users*

Related Topics

- Microsoft Overview in the Core Feature Guide

21.5. VOSS-4-UC Configuration and Sync

When using VOSS-4-UC with Microsoft (as a single or multiple vendor deployment scenario), you'll need to pre-configure several settings in VOSS-4-UC before importing Microsoft users, licenses, policies, and dialplans.

The flowchart sets out the initial configuration of VOSS-4-UC for Microsoft services.

Prerequisites:

- *Microsoft Configuration*

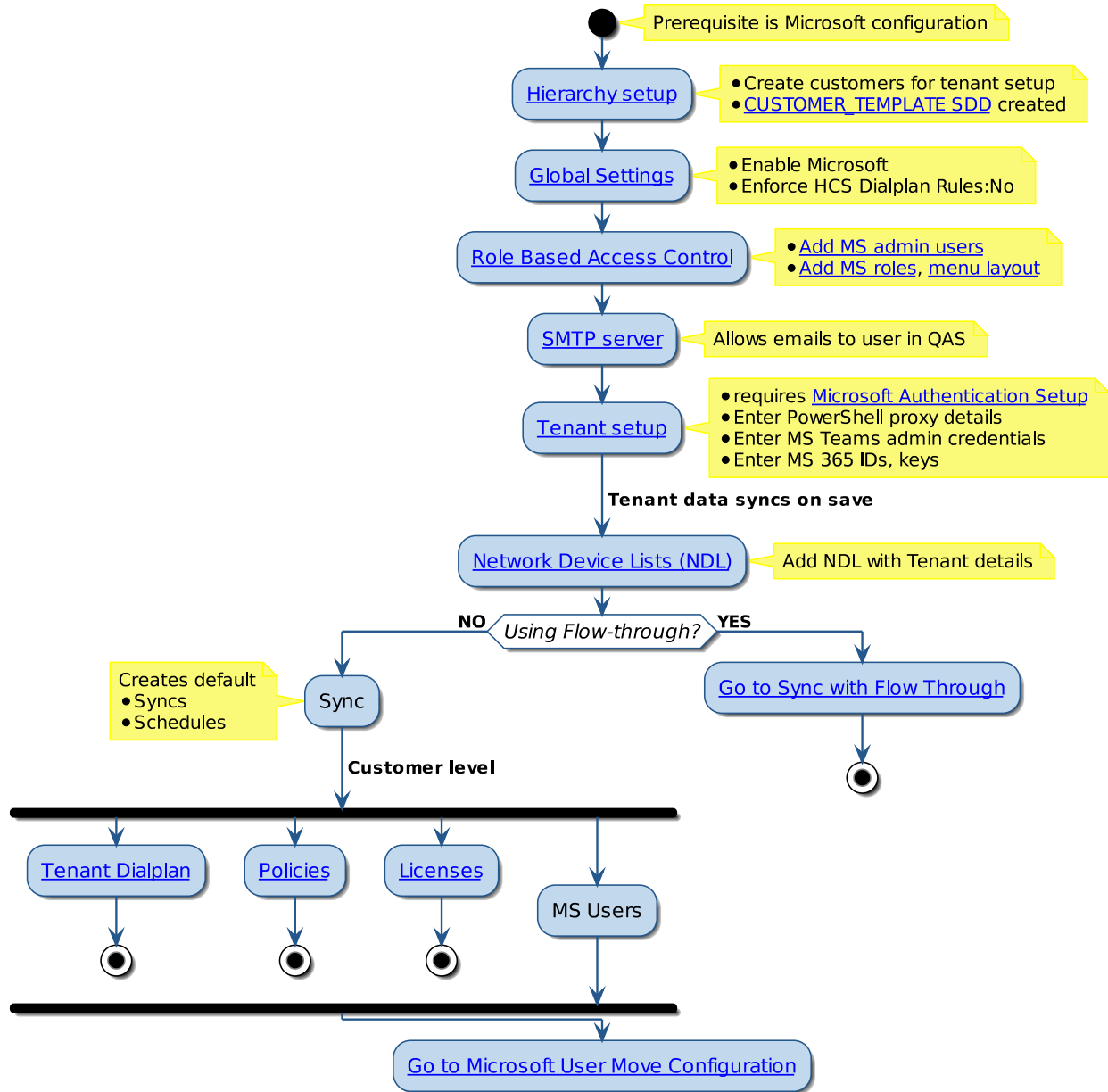

21.5.1. Workflow for the VOSS-4-UC and Microsoft Configuration and Sync

The high-level workflow for the steps in the flowchart are as follows:

1. Log in to VOSS-4-UC as a provider admin.
2. Add customers.
3. Go to **Customizations > Global Settings** to enable Microsoft:
 - On the **Enabled Services** tab, enable Microsoft services.
 - If you have a Microsoft-only environment, on the **Number Inventory** tab, set the following to **No** (False): **Enforce HCS Dialplan Rules**

Note: HSC dialplan is relevant only when using Cisco (in a single vendor or multi vendor installation).

4. Configure role-based access controls to apply to users on import:

VOSS-4-UC allows an admin user to set up pre-defined role-based configuration, which will be applied to users on import. This allows users to be auto-provisioned on import, with the correct services, lines, policies, and licenses.

When preparing for import, you'll need to create the admin users, service profiles, user roles, and role-based menu layouts (to hide or display functionality for different categories of users. For example, you can assign a Microsoft-only Business Admin Portal profile and Microsoft-only FDP to user roles for the Business Admin Portal in a Microsoft-only scenario. See Business Admin Portal Profiles in the Core Feature Guide for details.

- Add an admin user. See [Add an Admin User](#).
- Configure menu layouts, See [Create a Menu Layout](#).
- Add user roles, and choose menu layouts for the roles. See [Add and Edit Roles](#).
- Configure a SMTP server, if required. See [SMTP Server](#).

5. Configure a tenant, one for each customer. See [Configure Microsoft Tenant on VOSS-4-UC](#)

The tenant configuration defines how VOSS-4-UC connects to the Microsoft Cloud, to allow syncing of data between VOSS-4-UC and Microsoft Azure, Microsoft 365, and Microsoft Teams. Saving the tenant creates the default syncs and schedules.

6. Configure the network device lists (NDLs), which are required creating the sites. See [Add a Network Device List \(NDL\)](#)

7. Go to the Tenant and click **Action > Sync All** to run a full pull sync.

The tenant dialplan, policies, licenses, and Microsoft users are synced to the customer level.

Note: If you're using flow through provisioning for Microsoft users, additional steps are required before running the initial sync. See [Sync with Flow Through](#)

21.5.2. Next Steps

- Move users to the sites. See [Microsoft User Move Configuration](#)

21.5.3. Related Topics

- Microsoft Overview in the Core Feature Guide
- Sync with Flow Through in the Core Feature Guide

21.6. Microsoft User Move Configuration

This topic provides a workflow overview for moving Microsoft users to the sites once the Microsoft tenant has been added and a full pull sync has been performed. The sync imports the tenant dialplan, policies, licenses, and Microsoft users to the customer level. Now users must be provisioned and moved to the appropriate sites.

Prerequisites:

- *Microsoft Configuration*
- *VOSS-4-UC Configuration and Sync*

The flowchart sets out the steps to move Microsoft users to the sites after an initial sync to move users to the customer level:

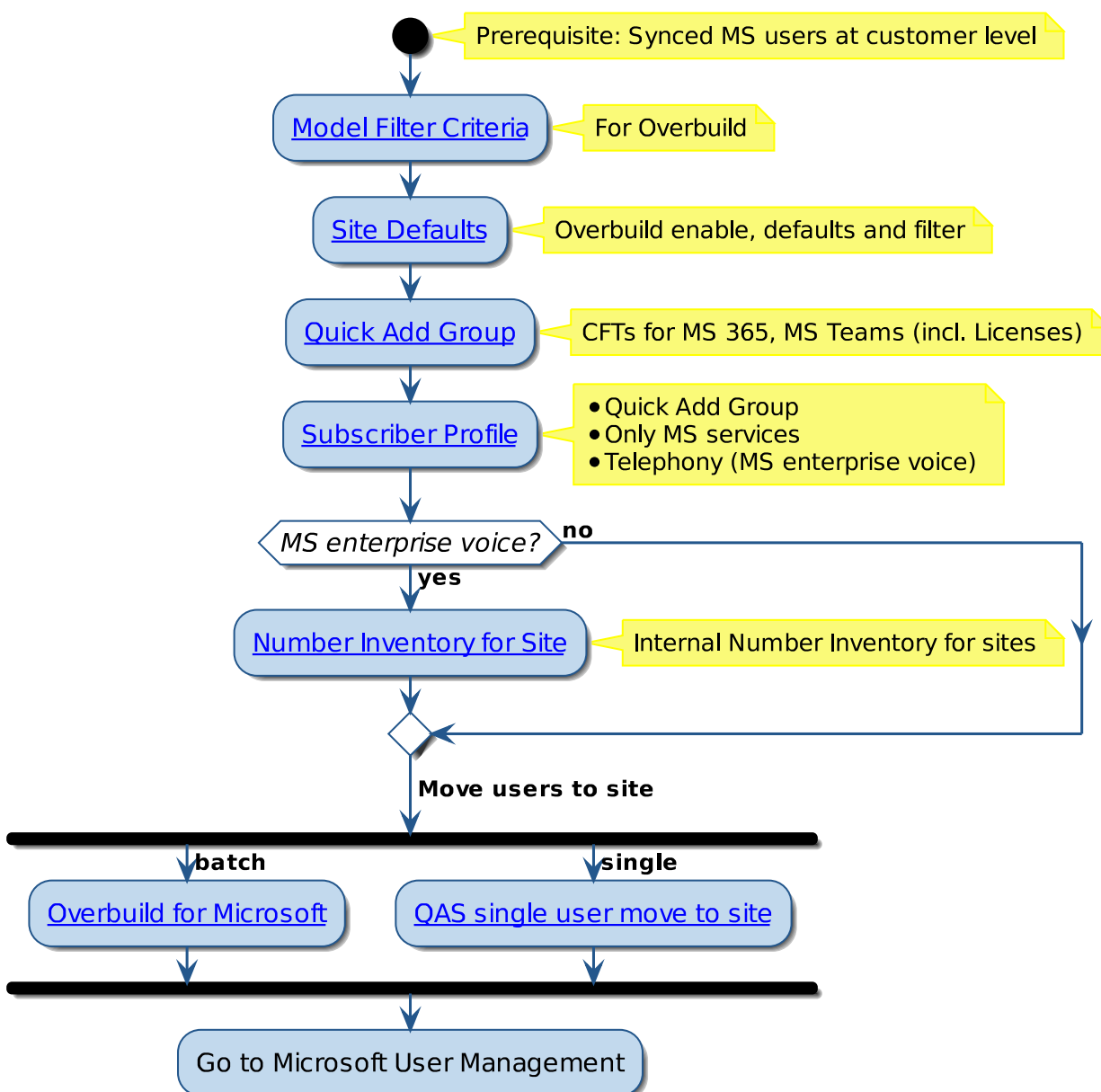

21.6.1. Related Topics

- [Microsoft Overview](#)
- [Sync with Flow Through](#)

21.7. Model Filter Criteria

Model filter criteria defines how the MSOL user is matched to corresponding data in VOSS-4-UC, and allows users and related data to be moved to the correct system levels (customer or site) on import (in a sync or overbuild), based on attributes defined for the user in Microsoft Azure.

Administrator users with access to the `data/ModelFilterCriteria` model can manage instances of this model so that these are available for selection in the Site Defaults Doc of a site.

The Site Defaults Doc provides a **MS 365 User Model Filter Criteria** drop down field to select the created model filter.

21.7.1. Create a Model Filter

1. Identify the source and target model and field that will be used in the filter.
2. Go to (default menu) **Customizations > Model Filter Criteria**.
3. Click Add to add a new record, or clone an existing model filter criteria and update it to create a new model filter.
4. Provide a **Name**, **Description**, and **Usage** (e.g. Overbuild) for the filter.
5. From the **Type** drop-down, select the source model, for example `device/msgraph/MsolUser`.
6. Click the Plus sign (+) in the **Criteria** group to add one or more criteria.

Each criteria is defined by the following:

Field	Description
Unary Operator	None, or NOT: to operate on the match Condition with the target value
Attribute	The field from the source model, for example <code>City</code> from <code>device/msgraph/MsolUser</code> .
Condition	Options are exact and non-exact types of contains and equals, as well as a regex search option.
Value	The target value that identifies the site in VOSS-4-UC. The value can also be a named macro, for example, <code>{{ macro.OVERBUILD_SITE_CITY_NAME }}</code> .
Conditional Operator	AND or OR: only needed and used to indicate the type of Boolean combination with the following criteria instance, if an additional instance is added.

7. Save the model filter.

The new model filter will now be available for selection in the Site Defaults Doc of a site, and will for example be applied in the Microsoft overbuild if **Include Site for Overbuild** and **Microsoft Users** is enabled.

When running the overbuild, the system loops through the site defaults to identify sites with **Include Site for Overbuild** enabled, and moves related user data to the site based on the chosen model filter criteria rule.

In this example, all `device/msgraph/MsolUser` instances synced in will be moved to the site matching `{{ macro.OVERBUILD_SITE_CITY_NAME }}` if their `City` value matches.

21.7.2. Related Topics

- Microsoft Overview in the Core Feature Guide
- Sync with Flow Through in the Core Feature Guide

21.8. Quick Add Subscriber for Microsoft Users

This procedure adds a single Microsoft user via quick add subscriber (QAS), and moves the user to the correct site, with all configuration and licensing applied.

Note: The Quick Add Subscriber (QAS) feature simplifies onboarding with the use of Quick Add Groups (QAGs). Quick Add Groups are service and policy assignment templates that allow you to pre-configure how calling rights, policies, and services are assigned to users based on their user role. When adding a user via QAS, you select the relevant QAG, and the automated workflows in VOSS-4-UC handles the required cloud sync and licensing. The workflow also removes the need for an administrator to check the licensing, or to flag the required policies and settings individually, and then to wait for the cloud to sync in.

Prerequisites:

- The Microsoft Teams user must be synced in at the customer level in VOSS-4-UC.
- The site defaults and Quick Add Group (QAG) must be set up with the correct model filter criteria rule to allow the workflow to move the user to the site with the appropriate configuration and licenses.

Perform these steps:

1. Log in to the Admin Portal as a provider admin, at the customer level.
2. Go to (default menu) **MS Subscriber Management > Quick Add Subscriber**.
3. From the organization picker, choose the relevant site.
4. On the Quick Add Subscriber page:
 - In the **Username** field, select the user.
 - Select **Include users at higher hierarchy** to show these users in the **Username** drop-down.
 - Select **Send welcome email** (if you wish to send the subscriber a welcome email once they've been added and configured via QAS, and if you have a SMTP server set up).
 - Select **Enterprise Voice Enabled** to display the Line URI field, where you can assign a line.

- From the **Line URI** drop-down, select a number.

Note: Only available numbers display. The INI will eventually update to this number.

- From **Calling Line Identity**, assign a calling line identity for this user.
- From the **Quick Add Group** drop-down, select the relevant Quick Add Group (to license the user to be enabled for telephony enterprise voice).
- Click **Save**.

5. Go to **MS Subscriber Management > Subscriber Staging** to view the user in the staging queue.

VOSS-4-UC places the user in staging (with all configuration applied), while waiting for the cloud to sync in. Once the licensed user appears in the Microsoft Teams portal, a second, targeted sync is triggered, which searches only for staged users (not all users from the tenant).

Once the sync completes, the user becomes a fully provisioned subscriber, and the number is flagged as used. The subscriber receives a welcome email (if you've chosen this option, and you have a SMTP server configured).

6. Verify that the subscriber is configured and licensed:

- Go to (default menu) **Subscriber Management > Subscribers**.

Note: The **Located At** column on the Subscriber list displays the hierarchy location of each subscriber added to the system, for example, customer or site.

- Click on the subscriber to open the Subscribers[name] page.
- On the **MS Licenses** tab, view the subscriber's license details.
- On the **MS Teams** tab, verify the following:
 - Enterprise voice is enabled
 - The user's number is allocated
 - Policies are assigned

21.8.1. Related Topics

- Microsoft Overview in the Core Feature Guide
- Microsoft User Move Configuration in the Core Feature Guide

21.9. Overbuild for Microsoft

Important: It is recommended that VOSS-4-UC training and/or VOSS Services are engaged during the initial use of the feature to help ensure optimized processes and guidance.

The Overbuild feature enables Provider and Reseller Administrators to integrate existing, deployed Microsoft Tenants into VOSS-4-UC without reprovisioning, unless required.

In VOSS-4-UC, a Microsoft Tenant shows the combined and specific details of a MS Office 365 and MS Teams tenant.

Overbuild provides tools to help the administrator manage Microsoft Tenant data synced from existing configurations.

While a Microsoft Tenant does not contain such VOSS-4-UC components as a hierarchy or a subscriber, the relationship with Microsoft Tenant components makes it possible to, for example, create a VOSS-4-UC subscriber at a site hierarchy during the Overbuild process. The necessary filters can be set up and workflows, macros and brownfield move processes are available for this purpose.

After overbuild is run for the first time, a schedule is created in VOSS-4-UC that can be set up to run at a selected interval.

Prerequisites

- Refer to [Microsoft User Move Configuration](#)

Overbuild logic

- **Users** - The synced in Microsoft Tenant user is moved to the site as mapped by the selected **MS 365 User Model Filter Criteria** dropdown of the sites Site defaults setting under **Overbuild Defaults** of sites if **Include Site for Overbuild** and **Microsoft Users** is enabled.

The **Overbuild Tool** screen shows a summary of **MS 365 Users** and **MS Teams Users** ..

- **Subscribers** - a MS Tenant user is can be set up for Enterprise voice using Quick Add Subscriber - see: [Quick Add Subscriber for Microsoft Users](#).

Site Defaults for Microsoft

- Under **Overbuild Defaults**:
 - **Include Site for Overbuild** is enabled
 - **Microsoft Users** is enabled.
 - **MS 365 User Model Filter Criteria** dropdown has a required filter selected. See [Model Filter Criteria](#).

Run Overbuild

1. Go to **Overbuild > Run Overbuild** to run configure and run the overbuild.
2. Choose the site.
3. In a Microsoft-only environment, select only **Microsoft Users** to include in the overbuild.
4. Save your changes to run the overbuild.

Note: The overbuild imports and provisions subscribers, including number assignment (INIs). It moves assigned numbers to the number inventory, flagged with the user's name, location (customer or site), number status (**Used** when assigned, else, **Available**), and the relevant vendor (Microsoft, in this case).

The number management step occurs on sync, overbuild, as well as in a number audit. You can run a number audit anytime to verify that numbers are correctly flagged as used or available (via **Number Management > Audit Number Inventory**) - see [Audit Number Inventory](#).

21.10. Sync with Flow Through

When using sync with flow through provisioning for Microsoft users, you will need to configure several settings in VOSS-4-UC (including flow through provisioning criteria) before the initial sync from the Microsoft Cloud. This allows VOSS-4-UC to apply the correct configuration, licenses, policies, and services to imported users, and to move users to sites.

Once you run the sync, the tenant dialplans, policies, and licenses are imported to the customer level, while users are imported, provisioned, licensed, and moved to the correct sites, as subscribers.

The flowchart sets out the sync with flow through of Microsoft user and services.

Prerequisites:

- Microsoft Configuration in the Core Feature Guide
- VOSS-4-UC Configuration and Sync in the Core Feature Guide

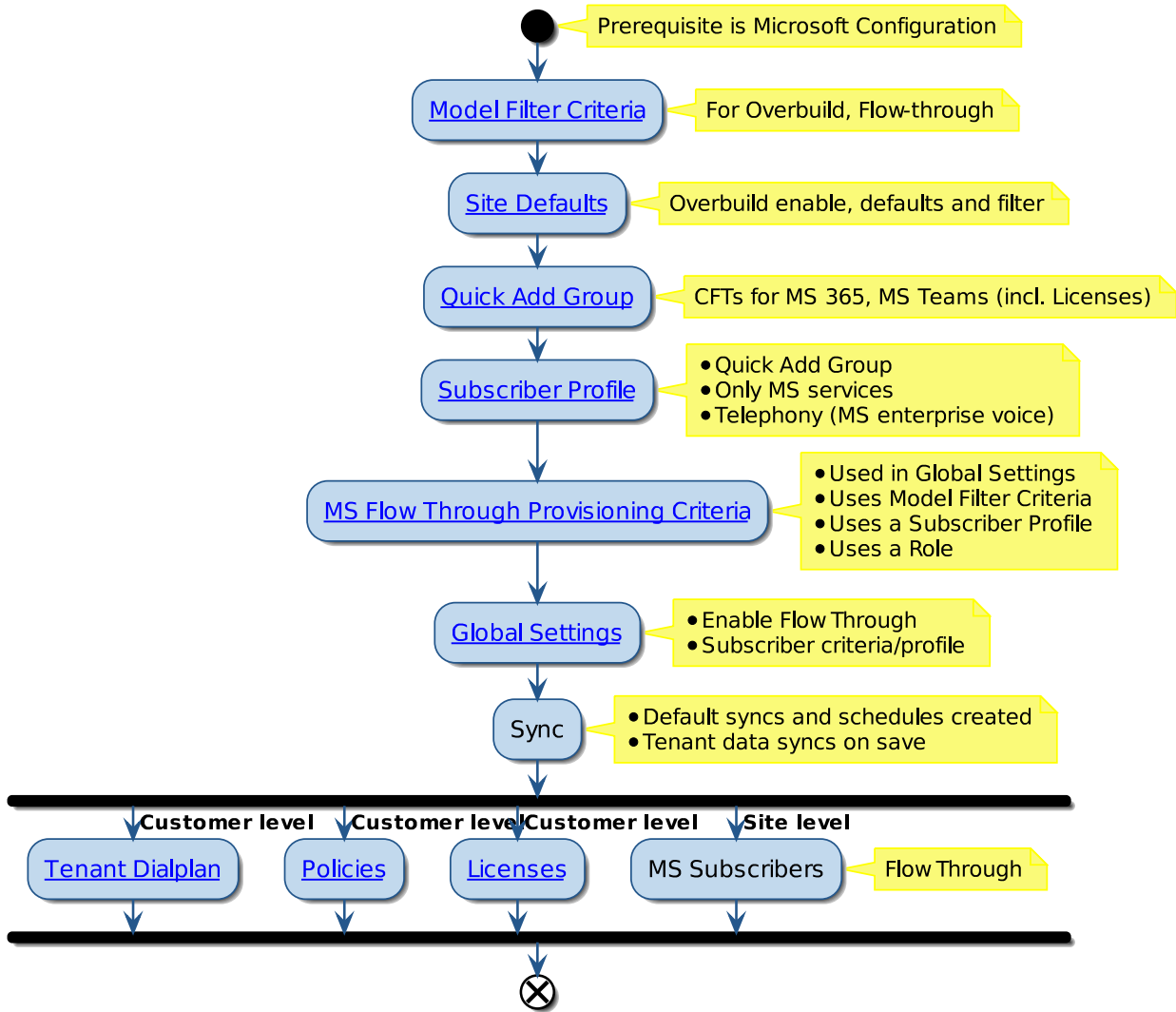

21.10.1. Related Topics

- Microsoft Overview in the Core Feature Guide

21.11. Flow Through Provisioning Criteria

VOSS-4-UC allows for flow through provisioning, in other words, for auto-provisioning users and services during user sync from devices.

Auto-provisioning typically references user attributes such as a user's department, division or city address. This filter is set up as *Model Filter Criteria*.

When setting up a **Flow Through Provisioning Criteria** instance, this initial **Model filter criteria** definition of user attributes is then further associated with additional properties for the user in VOSS-4-UC:

- **Profile:** Subscriber Profile that allows you to provision one or more subscribers with the same (or similar) set of resources and services.

- **User role**

An instance of **Flow Through Provisioning Criteria** that can be selected in the **Subscriber Criteria** drop down list of the **Global Settings, Flow Through Provisioning Criteria** tab. See: [Global Settings](#).

Related Topics

- Microsoft Overview in the Core Feature Guide
- Sync with Flow Through in the Core Feature Guide
- Subscriber Profiles in the Core Feature Guide
- User Roles in the Core Feature Guide

22. Services

22.1. Webex Teams

22.1.1. Webex Teams Feature Workflow

Webex Teams Feature Reference

Note: Only steps 1 and 2 below are mandatory for Webex Teams to function in VOSS-4-UC. The other steps are dependent on your particular requirements.

A typical Webex Teams workflow is:

1. Create Webex Teams Service (see [Create Webex Teams Service](#)).
2. Make sure that the **Webex Teams** check box is selected at the required hierarchy level under both **Entitlement > Catalogs** (see [Create an Entitlement Catalog](#)) and **Entitlement > Profiles** (see [Create an Entitlement Profile](#)).
3. Sync existing Webex Teams users for the customer by clicking **Action > Sync Webex Teams Users** on the **Customer Access** form. A sync can also be run by executing **SyncSpark[Customer]** from **Administration Tools > Data Sync**.
4. Add a Webex Teams user in VOSS-4-UC (see [Add Webex Teams User](#)).
5. Add Webex Teams users using **Subscriber Management > Subscribers**.
6. If you want to add a Webex Teams user using Quick Add Subscriber (QAS), choose the **Webex Teams User Template** to use for the user. This selection overrides the default user template referenced in the **Quick Add Subscriber Groups** associated to the user. If a **Webex Teams User Template** is not selected from the drop-down, selection falls back to the **Webex Teams User Template** referenced in the associated **Quick Add Subscriber Groups**. If you want customized values, clone the **Webex Teams User Template (Customizations > Configuration Templates)**, and edit as required.
7. Add Webex Teams users using **Subscriber Management > Quick Add Subscriber** (see [Webex Teams Quick Add](#)).
8. Provision Webex Teams for an existing user (see [Provision the Webex Teams Service](#)).

22.1.2. Create Webex Teams Service

This procedure adds a Webex Teams service.

Webex Teams Feature Reference

Prerequisites:

To allow VOSS-4-UC to connect to the Webex Teams Cloud API, obtain the following from the Cisco Webex page:

- a Webex Teams Organization Account Number
- an Access and Refresh token

Perform these steps:

1. Log in to the Admin GUI as a provider or reseller administrator.
2. Select the hierarchy path to the correct customer node.
3. Select **Services > Webex Teams > Access Token** to display **Webex Teams Account**.
The form opens on a separate tab, at the following URL: `https://us-centrall1-webex-teams-auth-token.cloudfunctions.net/webex_teams_oauth`
4. Click the **GET TOKENS** link.
5. In the **Email address** field on the **Cisco Webex** page, enter a valid email address; then, click **Next**.
An email address and password are only required the first time you log in to the Cisco Webex site.
6. In the **Password** field on the **Cisco Webex** page, enter a valid password; then, click **Sign In**.
7. View the codes/tokens generated and displayed on the form:
 - **Organization ID**
 - **Access Token** (14 days)
 - **Refresh Access Token** (90 days)

Note:

- VOSS-4-UC automatically refreshes the access tokens every 7 days. To manually refresh the access tokens, click **GET TOKENS** on the **Webex Teams Account** form or **Action > Refresh Access Token** on the **Customer Access** form.
 - The Refresh Token is valid for 90 days. The number of valid days remaining for the access token is displayed in the **Refresh Token Expires in** counter on the **Webex Teams Access Token Management for VOSS4UC** page.
 - See <https://developer.webex.com/docs/integrations> for more details on access token management.
-

8. Click on each **Copy** button in turn to copy the item, return to the VOSS-4-UC tab, and paste in the appropriate field on the **Customer Access** form. Note that the access tokens must also be pasted into the 'Repeat' fields.
9. Fill out, at minimum, the other mandatory fields on the **Customer Access** form under **Account Details**:

Field	Description
Webex Teams Customer Name	Populated automatically, using the customer name.
Default Calling Behaviour	Can be applied to synced in users, if also set in Global Settings (Automatically apply default calling behaviour on Webex Teams user data sync)
Use Organization's Domain	Can be enabled if you select option Calling in Webex Teams (Unified CM) (same as Webex Teams Control Hub behavior) When selected, you may also enable Default UC Manager Profile
Email Domain for Hybrid Calling in Workspaces	When hybrid calling is enabled for a workspace, a dummy subscriber email domain can be added.
Subscription ID	Fill out the subscription ID (as seen on the Control Hub portal) to selectively manage multiple subscriptions in multiple sites. If required, fill out the newly managed subscription ID here.
Site URL	The site URL for Webex Enterprise Edition meeting services. When syncing licenses and subscriptions, VOSS-4-UC only syncs in subscriptions matching the ID and services from the site. See also Webex Teams Licenses
Enterprise Content Management Enabled and	These settings match the configuration setting on the
Jabber Team Messaging Mode Enabled	user feature of the Webex Teams Control Hub, and apply to the corresponding Default Calling Behaviour selection: Calling in Webex Teams (Unified CM) and Cisco Jabber app. Note that with these calling behaviour options, Quick Add Group Templates for Jabber devices under the Webex Teams group are applied. See Quick Add Subscriber Groups Default Model
UC Manager Profiles	Added for use when managing users.
HTTP Proxy String	Required only if a proxy server is required to connect to the Webex Teams cloud, for example: <code>http://[ip address]:port</code>
HTTPS Proxy String	Required only if a proxy server is required to connect to the Webex Teams cloud, for example: <code>https://[ip address]:port</code>

10. Click **Save**. The Webex Teams Service is added.
11. Sync the Webex Teams Users for the customer. To do this, click **Action > Sync Webex Teams Users** on the **Customer Access** form.

Note: Webex Teams Users can also be synced from **Administration Tools > Data Sync**, and then running the SyncSpark[Customer] data.

Workflow Animation

The animation demonstrates how to create a Webex Teams service.

22.2. Auto Attendant (Call Handler)

22.2.1. Call Handler (Auto Attendant)

A call handler transfers telephone calls to the extension of a user or department without the intervention of a receptionist or operator, via a system of voice menus that the person initiating the call interacts with, using their telephone keypad or voice commands.

Note: Auto Attendant is a comprehensive service that provides for the provisioning, configuration and management of call handlers, greetings, schedules, and related dialplan components in Cisco Unity Connection (CUC) and Cisco Unified Communications Manager (CUCM).

Some call handler systems are comprised of message-only information menus and voice menus, which allow organizations to provide business information such as hours, directions to their premises, information about job opportunities, and to answer other frequently-asked questions. Once the message plays, the caller can be forwarded to a receptionist or they can return to the main menu.

Call handlers can be created at either customer level or at site Level:

- When created at customer level, a Network Device List (NDL) must be selected to instruct the workflow which UC Application Servers to provision.
- When created at site level, the NDL associated to the site is chosen automatically.

Related Topics

- Add a Call Handler (Auto Attendant) in the Core Feature Guide
- Modify a Call Handler (Auto Attendant) in the Core Feature Guide
- Manage Greeting Files in the Core Feature Guide
- Call Handler (Auto Attendant) Schedule in the Core Feature Guide
- Create a Call Handler (Auto Attendant) Schedule in the Core Feature Guide
- Modify a Call Handler (Auto Attendant) Schedule in the Core Feature Guide
- Add a Language Filter in the Core Feature Guide
- Add a TimeZone Filter in the Core Feature Guide

22.2.2. Add Call Handler (Auto Attendant)

This procedure adds a call handler to VOSS-4-UC and to Cisco Unity Connection (CUC).

Prerequisites:

- The relevant Cisco Unity Connection (CUC) call handler template must have been synced from CUC.

Note: Some of the configuration parameters required to provision the call handler are defined via the configuration templates and are not exposed in the user interface. For example, the following settings are hardcoded in the **AddCucmRoutePatternForCallhandlerCFT** configuration template:

- **Provide Outside Dial Tone = False**
- **Call Classification = OnNet**

To change these settings or any other values defined via the configuration template, clone the template (via **Customizations > Configuration Templates**) to the relevant hierarchy level, and edit the fields as required.

Perform these steps:

1. Log in as provider, reseller, or customer administrator.
2. Set the hierarchy path to the required customer or site node.
3. Choose (default menu) **Services > Auto Attendant > Call Handler**.
4. Click **Add** to add a call handler.
5. On the **Call Handler Basics** tab:

Note: Other tabs on this screen remain read-only until you've saved and added the new call handler: Transfer Rules, Caller Input, Greetings, Record/Playback, Upload Greeting. Once you've saved the new call handler, you can edit these settings. See **Modify a Call Handler (Auto Attendant)**.

- (Mandatory) From the **Network Device List** drop-down, choose the required network device list (NDL).

Note: This field is auto-populated (read-only) if you're adding the call handler at site level.

- (Mandatory) In the **Name** field, enter a name for the call handler.
- (Optional) From the **Pilot** drop-down, select a number that you want to associate with the call handler.

Note: This list displays a list of directory numbers that are available at the selected hierarchy. Selecting a pilot number displays the **Route List** drop-down.

- From the **Route List** drop-down, select the Cisco Unified CM route list to apply to the call handler.

Note: This drop-down displays if you've selected a pilot number. The NDL determines the route lists available in this drop-down. If the NDL changes, the drop-down list or route list options changes, based on the updated NDL.

- From the **Call Handler Template** drop-down, choose the CUC call handler template to apply the call handler.

Note: For more information about the call handler template, see the “Call Handler Templates” section of the “Call Management” chapter of the System Administration Guide for Cisco Unity Connection, Release 11.x.

6. Click **Save**.

Adding a call handler through VOSS-4-UC also adds a route pattern on the Cisco Unified CM designated in the NDL. The pattern is the value of the pilot selected.

The rest of the pilot configuration (including partition) is driven through a configuration template that can be cloned and modified. A direct routing rule is also created on the Cisco Unity Connection designated in the NDL. This rule accepts inbound calls into Cisco Unity Connection, and routes them to the relevant call handler.

Related Topics

- Call Handler (Auto Attendant) in the Core Feature Guide
- Modify a Call Handler (Auto Attendant) in the Core Feature Guide

22.2.3. Modify a Call Handler (Auto Attendant)

This procedure modifies a call handler.

Perform these steps:

1. Log in as provider, reseller, or customer administrator.
2. Choose the relevant hierarchy.
3. Go to (default menu) **Services > Auto Attendant > Call Handler**.
4. On the Call Handler page, click the call handler you want to modify.
5. On the **Call Handler Basics** tab, edit settings in the following fields, as required:

- **Pilot**

Note: If you're changing the pilot value, you'll need to select a value in the **Route List** drop-down.

- **Time Zone**
- **Schedule**
- **Phone System**
- **Language**
- **Partition Name**
- **Call Handler Owner** (User/owner)

Note: In the Call Handler Owner fields, selecting an owner associates a Unity Connection user to the owner of this call handler.

6. On the **Transfer Rules** tab, enable or disable the required transfer rules. Note the following:
 - The **Standard** transfer rule can't be disabled.
 - By default, the **Transfer Call To** action is set to **Greeting**. If the action is changed to **Extension or URI**, additional controls are exposed that allow you to enter an extension number or URI as well as the transfer type (Release to Switch or Supervise Transfer).
7. On the **Caller Input** tab, edit the default caller input.

Note: Choosing certain options on this tab displays additional fields. For example, choosing **User with Mailbox** (from the **Action** drop-down in the **Callhandler Menu Entry** fieldset) displays the **Transfer/Greeting** drop-down.

8. On the **Greetings** tab, edit the greeting settings.
9. On the **Record/Playback** tab, configure the greeting you want to record and playback on the chosen extension.

This interface allows administrators to trigger a call to a physical device, which allows for recording or playback of a greeting. The extension to dial must be an accessible extension for the administrator (or user) to answer and record or listen to greetings.

- From the **Extension** drop-down, select an extension, or manually type in the number of the device you want to call to record or listen to a greeting.
 - To record or playback a greeting for a specific purpose, select the **Specific Greeting** checkbox; else, the action applies to the main call handler.
 - In the **Duration (seconds)** field:
 - Specify a time period (in seconds) that the system allows for recording a greeting.
This time duration does not apply when playing back a recording. Ensure you set this timer appropriately. Setting it too low may result in an incorrect configuration.
 - Before saving the settings on this tab, go to **Action > Record Greeting**, or to **Action > Playback Greeting** (as applicable) to record or playback the greeting you wish to use.
10. On the **Upload Greeting** tab:
 - From the **Greeting File** drop-down, choose the greeting file (.wav) to upload to the call handler.
 - Configure the specific greeting (if required).
 11. Click **Save**. Changes are saved to the call handler in VOSS-4-UC and in Cisco Unity Connection.

Delete a Call Handler

To delete a call handler, click on the call handler you want to delete; then, click **Delete**. On the pop-up, click **Yes** to confirm.

Related Topics

- See “System Call Handlers” in the “Cisco Unity Connection System Administration Guide for more information about Call Handlers.
- Call Handler (Auto Attendant) in the Core Feature Guide
- Manage Greeting Files in the Core Feature Guide

Call Handler Basics Tab

Title	Field Name	Description
Network Device List *	HF.target_ndl	Mandatory input-field for the option (if hierarchy is at Site-node, however, this value is derived automatically). The workflow (and GUI rules) will target the UC devices that is linked to this Network Device List (NDL). In the Mod use-case, this should also be derived automatically and can thus be omitted from Updates.
Cisco Unity Connection	HF.cuc_info	Informative (non-input) field. Indicates the target CUCx host/IP, which is automatically derived from the input NDL.
Cisco Unified CM	HF.cucm_info	Informative (non-input) field. Indicates the target CUCM host/IP, which is automatically derived from the input NDL.
Name *	DisplayName	The text name of the handler to be used when displaying entries in the administrative console, e.g. Cisco Unity Connection Administration. For example, the display name for the default opening greeting call handler is “Opening Greeting.”
Route List	route_list	The CUCM Route List to use. The valid options are dependent on the selected NDL/CUCM. console, e.g. Cisco Unity Connection Administration. For example, the display name for the default opening greeting call handler is “Opening Greeting.”
Pilot	DtmfAccessId	The DTMF access id (i.e., extension) for the call handler. The dialable number.
Call Handler Template	cuc_template	Select the Unity Template for Call Handler.

Transfer Rules Tab

Title	Field Name	Description
Message	callerInput_tab_message	Caller Input
Callhandler Menu Entry	CallhandlerMenuEntry.[n]	
Object Id	ObjectId	The primary key for this table. A globally unique, system-generated identifier for a MenuEntry object.
Call Handler *	CallHandlerObjectId	The unique identifier of the CallHandler object to which this menu entry belongs.
Touchtone Key	TouchtoneKey	The character on the touch-tone keypad that this menu entry corresponds to (* , #, 0,1...9).
Ignore Additional Input (Locked)	Locked	A flag indicating whether Cisco Unity Connection ignores additional input after callers press this key. Values: 0: Additional input accepted 1: Additional input ignored; Cisco Unity Connection performs the action assigned to the key.
Call Action	Action	The type of call action to take, e.g., hang-up, goto another object, etc.
Extension or URI	TransferNumber	This setting only applies if "Call Action" is set to 'Transfer to Alternate Contact Number'.
Description	DisplayName	This setting only applies if "Call Action" is set to 'Transfer to Alternate Contact Number'.
Transfer Type	TransferType	This setting only applies if "Call Action" is set to 'Transfer to Alternate Contact Number'.
Rings to Wait for	TransferRings	This setting only applies if "Call Action" is set to 'Transfer to Alternate Contact Number'.
Target Conversation	TargetConversation	The name of the conversation to which the caller is routed.
Target Handler Object Id	TargetHandlerObjectId	The unique identifier of the specific object to send along to the target conversation.

Caller Input Tab

The table describes fields on this tab:

Wait for Additional Digits (milliseconds)	The amount of time (in milliseconds) that Cisco Unity Connection (CUC) waits for additional input after a caller presses a single, unlocked key. If there's no input within this time, CUC performs the action assigned to the key.
Enable Prepend Digits to Dialed Extensions	Defines whether to prepend digits when dialing an extension number to transfer to.
Digits to Prepend	The touch-tone digits to prepend to the extension when dialing the transfer number.

Note: These fields are exposed automatically in the default FDP for relation/CallhandlerREL. If the FDP has been customized, you'll need to expose these fields manually by exposing the following field names: OneKeyDelay, EnablePrependDigits, PrependDigits

The table describes options in the **Call Handler Menu Entry** fieldsets:

Title	Field Name	Description
Message	callerInput_tab_message	
Callhandler Menu Entry	CallhandlerMenuEntry.[n]	
Object Id	ObjectId	The primary key for this table. A globally unique, system-generated identifier for a MenuEntry object.
Call Handler *	CallHandlerObjectId	The unique identifier of the Call Handler object to which this menu entry belongs.
Touchtone Key	TouchtoneKey	The character on the touch-tone keypad that this menu entry corresponds to (* , #, 0,1...9).
Ignore Additional Input (Locked)	Locked	A flag indicating whether Cisco Unity Connection ignores additional input after callers press this key. Values: 0: Additional input accepted 1: Additional input ignored; Cisco Unity Connection performs the action assigned to the key.
Call Action	Action	The type of call action to take, e.g., hang-up, goto another object, etc.
Extension or URI	TransferNumber	This setting only applies if "Call Action" is set to 'Transfer to Alternate Contact Number'.
Description	DisplayName	This setting only applies if "Call Action" is set to 'Transfer to Alternate Contact Number'.
Transfer Type	TransferType	This setting only applies if "Call Action" is set to 'Transfer to Alternate Contact Number'.
Rings to Wait for	TransferRings	This setting only applies if "Call Action" is set to 'Transfer to Alternate Contact Number'.
Target Conversation	TargetConversation	The name of the conversation to which the caller is routed.
Target Handler Object Id	TargetHandlerObjectId	The unique identifier of the specific object to send along to the target conversation.

Greetings Tab

Title	Field Name	Description
Message	greetings_tab_message	
Greeting	Greeting.[n]	
Greeting Type	Enabled	The type of greeting, e.g. "Standard," "Off Hours," "Busy," etc.
Enabled	Enabled	If TimeExpires is set, this field is ignored.
Time Expires	TimeExpires	The date and time when the greeting rule expires. The greeting rule is considered not expired (enabled), if the value is NULL or a future date. The greeting rule is considered expired (disabled), the value is in the past.
Callers Hear	PlayWhat	The source for the greeting when this greeting is active.
Play the "Record Your Message at the tone" Prompt	PlayRecordMessage Prompt	A flag indicating whether the "Record your message at the tone?" prompt prior to recording a message.
Callers See My Personal Recording	EnablePersonal Video-Recording	It will Enable the Personal video Recording in CUCA.
Callers See Play the "Record Your Message at the Tone" Prompt	PlayRecordVideo MessagePrompt	A flag indicating whether the "Record your message at the tone?" prompt prior to Video recording a message.
Ignore Caller Input During Greeting	IgnoreDigits	A flag indicating whether Cisco Unity Connection takes action in response to touchtone keys pressed by callers during the greeting.
Allow Transfers to Numbers Not Associated with Users or Call Handlers	EnableTransfer	A flag indicating when an extension is dialed at the greeting and the extension is not available whether to transfer to another extension.
Times to Re-prompt Caller	Reprompts	The number of times to reprompt a caller. After the number of times indicated here, Cisco Unity Connection performs the after-greeting action.
Delay between Re-prompts	RepromptDelay	The amount of time (in seconds) that Cisco Unity Connection waits without receiving any input from a caller before Cisco Unity Connection prompts the caller again.

Title	Field Name	Description
After Greeting	AfterGreetingAction	The type of call action to take, for example, hang-up, goto another object, etc.
After Greeting Target Conversation	AfterGreetingTarget Conversation	The name of the conversation to which the caller is routed.
After Greeting Target Handler Object Id	AfterGreetingTarget HandlerObjectld	The unique identifier of the specific object to send along to the target conversation.
Call Handler Object Id	CallHandlerObjectld	The unique identifier of the Call Handler object to which this greeting rule belongs.
Callhandler URI	CallhandlerURI	
Greeting Stream Files URI	GreetingStreamFilesURI	
Greetings Type	GreetingType	The type of greeting, e.g. "Standard," "Off Hours," "Busy," etc.
URI	URI	

Record/Playback Tab

Title	Field Name	Description
Message	RecordPlayback.note	A special interface, which allows administrators to trigger a call to a physical device, which allows for recording or playback of a greeting. The extension to dial must be an accessible extension for the admin (or user) to answer and record or listen to greetings.
Call Handler Name	RecordPlayback.call_handler	Call Handler Name.
Extension	RecordPlayback.extension	Extension to Record message on.
Specific Greeting	RecordPlayback.specific_greeting	The unique identifier of the Call Handler object to which this menu entry belongs.
Greetings	RecordPlayback.greeting	Greetings.
Duration	RecordPlayback.duration	Duration to allow enough time to make recording/playback.

Upload Greeting Tab

Title	Field Name	Description
Message	note	Upload a greeting to the selected Call Handler.
Greeting File	Upload.filename	Call Handler Name.
Call Handler Name	Upload.call_handler	Call Handler Name.
Specific Greeting	Upload.specific_greeting	Specific Greeting.
Greetings	Upload.greeting	Greetings.

22.2.4. Call Handler (Auto Attendant) Schedule

Note: You can only manage schedules at the same hierarchy level (or lower) as your log in level. For example, if you login as a customer administrator, you can view schedules at your own customer hierarchy level, and add new schedules at (or below) your hierarchy level.

During initial installation, VOSS-4-UC imports two predefined schedules from Cisco Unity Connection. These are accessed via **Services > Auto Attendant > Schedule**:

- **All Hours**
- **Weekdays**

By default, the **All Hours** schedule is configured to be “active” 24 hours a day, 7 days a week, with no holidays. Routing rules that follow this schedule will always be active, and call handlers that use this schedule ‘as is’, will never use off hour transfer settings or play closed greetings.

The **Weekdays** schedule is configured to be active from 8 a.m. to 5 p.m. (in the time zone of the Cisco Unity Connection server) from Monday through Friday. It is also configured to observe any days and times that are set in the default Holidays schedule.

Note: By default the **Holidays** schedule is not configured for any days or times. — at a minimum you may want to add days and times to this holiday schedule when your organization will be closed.

Designating Holidays

When a Holiday setting is in effect, holiday greetings are played (if enabled), and off hours transfer rules are observed. You can set up several years of holidays at a time. Because many holidays occur on different dates each year, confirm that the holiday schedule remains accurate annually.

See also:

- [Create a Call Handler \(Auto Attendant\) Schedule](#)
- [Modify a Call Handler \(Auto Attendant\) Schedule](#)

22.2.5. Create a Call Handler (Auto Attendant) Schedule

You may want to create a new schedule for your organization.

On the **Schedule** form (modify or add), take note of the following field:

Uses Holiday Schedule - If you want your schedule to recognise days that are included as holidays in a holiday schedule, then choose a holiday schedule from the **Uses Holiday Schedule** drop-down list. Any day included in the selected holiday schedule will be recognized as a holiday.

If you want to create a new holiday schedule:

1. Select the **Is Holiday** check box.
2. Click **Holiday Details +** enter the following fields:
 - **Name**
 - **Holiday Start Date**
 - **Holiday End Date**

- **Start Time**
- **End Time.**

3. Add more days to the holiday as required by clicking **+** next to the entered holiday, and entering new details in the fields.
4. Click **Save** when complete.

Note: Another method to create a new schedule is to:

1. Select an existing schedule from the **Schedule** list view.
 2. Clone it (**Action > Clone**) to the desired hierarchy level.
 3. Edit as required.
 4. Click **Save**.
-

22.2.6. Modify a Call Handler (Auto Attendant) Schedule

To edit a Call Handler schedule:

1. From the **Schedule** list view, click on the schedule that you want to edit.
2. Select the **Schedule Details** link name and edit the required fields (as described under [Create a Call Handler \(Auto Attendant\) Schedule](#)).
3. Click **Save** when complete.

To delete a Call Handler schedule:

1. From the **Schedule** list view, select the check box next to the schedule you want to delete. If you want to delete more than one schedule, select multiple check boxes.
2. Click **Delete** on the button bar.
3. Click **Yes** on the dialog box to delete.

22.3. Manage Greeting Files

22.3.1. Manage Greeting Files

This option allows you to independently upload previously created greeting (.wav) files, which can be used when adding or updating call handlers at a hierarchy level.

Note: The Unity Connection server port that is used when uploading greeting files is the port specified during Unity Connection Publisher setup - see [Set up Cisco Unity Connection](#).

1. Click **Auto Attendant > Manage Greeting Files**.
2. Click **Add**.
3. Click **Browse** to select the required greeting file from the directory in which it was saved.

4. Enter an optional description to uniquely identify the greeting file.
5. Click **Save**.

Uploaded greeting files are available to use on the **Record/Playback** and **Upload Greeting** tabs when you modify a call handler, see *Modify a Call Handler (Auto Attendant)*.

22.4. Cisco Unity Connection (CUC) Localization

22.4.1. Cisco Unity Connection Localization

Provider administrators or higher can manage multi-site, multi-country customers by setting geo-specific information using the Site Defaults Doc. Using this information, administrators can use custom Configuration Templates (as in the Quick Add Group for Quick Add Subscriber), to set this information on a per-site level.

Timezones and languages in VOSS-4-UC are populated with the required CUC timezones and languages. These are typically selected from the relevant drop-down lists as described under Modify Site Defaults.

Note: You must only add timezone and language codes in VOSS-4-UC that match the installed timezones and languages on the associated CUC Server. The names entered must uniquely describe the timezone and code.

See also:

- [Add a TimeZone Filter](#)
- [Add a Language Filter](#)

22.4.2. Add a TimeZone Filter

To add a custom Cisco Unity Connection timezone filter:

1. Log in as provider administrator or higher.
2. Choose **Services > Cisco Unity Connection Localization > TimeZone Filters** to see a list of timezone filters currently in VOSS-4-UC.
3. Click **Add**.
4. Enter the following:
 - a. **TimeZone Code** - this is a mandatory field, and must match a timezone code installed on the associated Cisco Unity Connection Server.
 - b. **TimeZone Name** - this is a mandatory field, and must be a unique description for the timezone code above.
5. Click **Save**.

22.4.3. Add a Language Filter

To add a custom Cisco Unity Connection language filter:

1. Log in as provider administrator or higher.
2. Choose **Services > Cisco Unity Connection Localization > Language Filters** to see a list of language filters currently in VOSS-4-UC.
3. Click **Add**.
4. Enter the following:
 - a. **Installed Language Code** - this is a mandatory field, and must match a language code installed on the associated Cisco Unity Connection Server.
 - b. **Language Name** - this is a mandatory field, and must be a unique description for the language code above.
5. Click **Save**.

23. Overbuild

23.1. Overbuild Introduction

23.1.1. Overbuild Overview

Important: It is recommended that VOSS-4-UC training and/or VOSS Services are engaged during the initial use of the feature to help ensure optimized processes and guidance.

Note: References to HCM-F and Shared Data Repository (SDR) are only relevant if installed.

The Overbuild feature enables Provider and Reseller Administrators to integrate an existing, deployed Unified Communications (UC) system into VOSS-4-UC without reprovisioning, unless required. This option is available for single-cluster dedicated deployments only. Overbuild provides tools to help the administrator manage the data synced from existing configurations in Cisco Unified Communications Manager and Cisco Unity Connection.

Although a deployed Unified CM system does not contain such VOSS-4-UC components as a hierarchy or a subscriber, the relationship between Unified CM components makes it possible to, for example, create a VOSS-4-UC subscriber at a site hierarchy during the Overbuild process. The necessary workflows, macros and brownfield move processes are available for this purpose. You will not need to access these tools directly; they are part of the **Run Overbuild** menu interface.

The Overbuild logic can be summarized as follows:

- **Phones** - This is based on the device pool of the phone. It will be moved to a site based on the device pool matching one of the device pools set up under the site defaults for a site.
- **Dual Mode Remote Destinations** - This will move the remote destination to the site of the dual mode device
- **Users** - If the user has an associated phone then the user is moved to the same site as the phone.

If the user does not have an associated phone then the user must be manually moved to the relevant site using the Move Users menu option under either **User Management** or **Overbuild**.

It is recommended this happens prior to the Overbuild process so that all their related services are moved during overbuild; otherwise the Overbuild will need to be run again after moving the user to handle their related services.

- **Device Profiles** - this will move the device profile to the same site as the user associated to the device profile.

- **Remote Destination Profiles** - this logic is the same as phones - based on the device pool of the RDP. It will be moved to a site based on the device pool matching one of the device pools setup under the site defaults for a site.
- **Remote Destinations** - this will move the RD to the same site as the associated RDP
- **Lines** - this will move the line to the same site as the phone/device profile/RDP it is associated to.
- **CUC Users** - this will move the voicemail user to the same site as the base user.
- **Webex Teams Users** - this will move existing Webex Teams Users that are synced into VOSS-4-UC to the same site as the base user (if it finds a matching email address).
- **Contact Center Agents** - this will move contact center agents to the same site as the base user (if it finds a matching Unified CM user ID).

The Overbuild process involves five broad steps:

- Perform initial manual setup and configuration on VOSS-4-UC.
 - The business information of the existing, deployed system is identified and entered into VOSS-4-UC, optionally by the bulk load process. This means hierarchy information is created with customers, sites and site codes. Some configuration data is initially generated, for example Site Defaults data. This data should be modified if required according to Unified CM data, so that Overbuild processing can move data to required sites.

For example, the default, generated VOSS-4-UC Site Defaults for a site have the Site name as the Device Pool name. Since the Site Defaults are used in the Overbuild process, this name should be modified to match the Device Pool name on the imported Phones before the Overbuild process is run. VOSS-4-UC allows Provider and Reseller Administrators to modify Site Defaults in order to modify the configuration of an Overbuild process.

Note:

While Customers and Sites have access to the Site Defaults under the **Site Management** menu, the **Overbuild Defaults** tab is only visible to Provider and Reseller Administrators.

- Network device connections are identified, created, associated with a Network Device List, and imported. This includes Unified CM and CUCX clusters.

Caution:

Whenever this data is synced in, it becomes managed by VOSS-4-UC and, as a result, would be deleted by any hierarchy delete. See [Delete Issues and Purges](#) for information on managing these issues.

One Unified CM typically belongs to a customer and resides in a cluster, so this device import takes place at the created customer hierarchy. The device can also be associated with a Network Device List on VOSS-4-UC that is mapped to a created hierarchy.

- If the **Users** check box is selected on the **Run Overbuild** tool, users exposed under the **User Management** menu are moved to the site of their associated phones as specified in the Site Defaults Doc Device Pools.

Users without phones will not be moved and can be moved separately - see [Move Users](#).

The following model instances are moved from customer level to the site level:

- data/User
- data/HCSHcmfUserDAT
- device/cucm/User
- device/hcmf/User (only if HCM-F is installed)

- If the **Lines** check box is selected on the **Run Overbuild** tool, lines are moved to the relevant site, and marked as in use in the Directory Number (DN) inventory. If a matching DN inventory entry does not exist then one is created. DN entries are created at site by default unless the **Create Internal Number Inventory at Customer** check box is selected on the Site Defaults Doc **Overbuild Defaults** tab.
- The **Run Overbuild** tool selects which data to move based on device pool configurations. You can run the tool for all sites, or a particular site.

Note:

The existing system's provisioned phones that have been imported should have their Device Pools matched with Site Default Data values on each specific site.

The imported elements are moved according to Overbuild Move Workflows, which are triggered by the **Run Overbuild** tool. These workflows identify imported network device data and move it to the site hierarchy that corresponds to the existing deployed site.

- Manually validate and modify the overbuild run by reviewing the moved items using **Overview Tool**. Use Device Models and/or Relations to move, update, delete, and in a few limited cases add instances of device types for the selected hierarchy.
- Perform post-move operations:
 - Perform Self Care authentication provisioning steps for non-LDAP, LDAP, and SSO-enabled scenarios - see [User Authentication](#).

23.1.2. Overbuild Steps

Important: System Integrator Support Recommended - For all Managed Services: Day 2 Overbuild Projects, we recommend support from a System Integrator.

Provider and Reseller Administrators can follow these general steps to use the Overbuild tool:

1. Provision the business hierarchy. This can be done manually in VOSS-4-UC or by bulk load (see "Bulk Administration" topics and [Bulk Loading a File](#)).
2. Provision Cisco UC Applications, network device lists, and network device list references. Once UC Applications are configured, the sync from Cisco Unified Communications Manager will be scheduled and executed. See "Data Sync" topics.
3. Choose the device pool and devices for the site on both the **Site Defaults > General** and **Overbuild Defaults** tabs. See [Overbuild Site Defaults: Overview](#).
4. Choose **Run Overbuild** to move the imported UC Applications data into the site hierarchy that corresponds with the existing deployed site. See [Run Overbuild: Overview](#).
 - Users exposed under the **User Management** menu are moved to their associated phones if the **Users** check box is selected on the **Run Overbuild** tool.

Users are moved to their phones if the phones have the user set as the OwnerUserID, if the **Users** check box is selected on the **Run Overbuild** tool.

Note: The User's role is not changed when moving to Site.
 - Lines are moved and marked as in use in the Directory Number (DN) inventory if the **Lines** check box is selected on the **Run Overbuild** tool. A Site DN inventory is created.

If the DN instance already exists, it is updated as in use. The DN inventory instance is created at the site level by default. This can be set to Customer in the SiteDefaultDoc before running OverBuild.

Note: Adding Directory Number inventory at Customer level is only possible if the DialPlan in use is non SLC(Site Location) Based, or if no DialPlan is in use.

5. Choose **Overview Tool** to verify the number of Unified Communications elements at the selected hierarchy and below. See *Summary of the Overview Tool*.
6. Optionally, review the device model types listed with hierarchy in the Device Models or **Subscriber Management** menu. See *Device Models: Overview*.

23.2. Moving Model Instances

23.2.1. Moving Model Instances: Overview

If the Move operation is enabled for a model, instances can be moved from its current hierarchy level to another level. Data models, Device models and Relations can be enabled for the Move operation. For lists of objects moved during a move operation, see *Objects that are Moved During the Overbuild* for data and device models, and *Subscriber Management Models* for Subscriber Management models.

Instances can only be moved up in the hierarchy if the administrator is at a higher hierarchy. For example, for an instance at level cust1.site1 and the level cust1.site2 also exists, then the user needs to be at level cust1 to carry out a move of this instance 'sideways' to cust1.site2 by going up and back down the hierarchy levels.

The move is typically used in conjunction with data sync, which pulls the entities in, for example users, phones, dial plan, and so on. By default the entities reside at the level of the cluster, so the move feature allows them to be allocated to a different hierarchy (if needed).

23.2.2. Move Rules

From the user interface, the following move rules apply:

- On the Admin Portal, the only option shown on the drop-down is to move an item to a lower hierarchy.
- For the core application and the Overbuild tool:
 - LDAP device models can be moved to a hierarchy that is at or below the hierarchy where the device is located, regardless of the Network Device List Reference (NDLR).
 - Non-LDAP device models can be moved to a hierarchy where the device is located.
 - Non-LDAP device models can be moved to a hierarchy where the NDLR references the associated device.
 - Other instances at a hierarchy node can only be moved to a hierarchy that is below their current hierarchy.

Once the resource is moved, metadata of all the resources at the moved hierarchy and below is updated to indicate the latest changes in the hierarchy path.

Note: For User Management local administrators and users, where the language is derived from the default hierarchy language, the default language is recalculated based on the new hierarchy tree location.

23.2.3. Subscriber Management Models

Administrators have privileges to manually move these Subscriber Management Menu models:

- Lines
- Voicemail
- WebEx
- Webex Teams
- Hunt Groups
- Call Pickup Groups

It is recommended to use the dedicated tools to move subscribers and phones between customer and site hierarchy levels.

23.2.4. Move Subscriber Management List View Items

Perform these steps:

1. Log in as a Customer Administrator or higher.
2. Choose the hierarchy level of the **Subscriber Management** menu item from which you want to move the items.
3. From the list view, choose the items to be moved by selecting the check boxes next to the items.
4. Click **Action > Move**. A form prompts you to choose the target hierarchy from a drop-down list.
5. Choose the target hierarchy and click **OK**.

The items are moved to the selected hierarchy, and will then be shown in their new hierarchy.

23.3. Overbuild Site Defaults

23.3.1. Overbuild Site Defaults: Overview

Important: System Integrator Support Recommended - For all Managed Services: Day 2 Overbuild Projects, we recommend support from a System Integrator.

While Customers and Sites have access to Site Defaults under the Site Management menu, the Overbuild Defaults tab is only visible to Provider and Reseller Administrators.

The settings on the Overbuild Defaults tab of Site Defaults determine if and how imported objects are moved to the site hierarchy during an Overbuild process.

The settings on this tab work as follows:

- **Include Site for Overbuild:** If selected, the site is included in the Overbuild and all the settings on the Site Defaults tabs apply.

The list of defaults when the menu **Site Management > Defaults** is selected, show “true” in the Include Site for Overbuild column.

- **Create Internal Number Inventory at Customer:** If clear, the internal number inventory is created at site level only. If selected, the internal number inventory is created at customer level only, and will be used by all sites belonging to that customer, default = cleared.

Caution: If Overbuild has already been run for a site and the Internal Number Inventory has been created for the Site, if the option ‘Create Internal Number Inventory at Customer’ is enabled and Overbuild is run for the same Site, then a duplicate set of Internal Number Inventory will be created at the Customer. The same applies if the ‘Create Internal Number Inventory at Customer’ is enabled when Overbuild is run for the Site, if it is then disabled and Overbuild is run again, a duplicate set of Internal Number Inventory will be created at the Site.

- **Additional Device Pools:** By default, if a site is included for the Overbuild process, the Default CUCM Device Pool on the General Defaults tab has to match the Device Pool of the phones that have been imported in order for these and their related objects to be moved to the site at which the Site Defaults Doc exists. The Run Overbuild tool uses the Device Pool in order to determine which devices and models are to be moved to the site where the site defaults are defined.

However, additional Device Pools can be added, so that more than one Device Pool from those of the imported phones can be moved to the same site. Additional Device Pools are selected from the Device Pool Name drop-down list as instances of the Additional Device Pools group control.

The names of the additional Device Pools can be renamed to the Default Device Pool name as entered on the General Defaults tab if the Replace with Default Device Pool box is selected.

- **Overbuild Device Control:**
 - **Move All Devices:** If selected, all matching and related imported devices are moved to the site.
 - **Limit Moved Devices:** If selected, check boxes appear for selecting devices to import to the site. This corresponds with the controls and logic on the Run Overbuild interface. For details on the interdependency and available options when check boxes are selected, see [Run Overbuild: Overview](#).

23.4. Run Overbuild

23.4.1. Run Overbuild: Overview

Run Overbuild processes Unified CM imported objects for all sites in the current customer. It must be run at the Customer hierarchy.

A device model is moved to a site on condition that there is a Network Device List Reference (NDLR) referencing the device at the site.

Note: The line goes to the first site that the Run Overbuild tool finds. The site selection is not deterministic.

The conditions for creating or updating the INI (Internal Number Inventory) during Overbuild are listed in the table below:

Given	Then
<ul style="list-style-type: none"> • INI exists at Site. • Site Defaults “Create Internal Number Inventory at Customer” check box is clear. 	The lines in the INI at the Site are updated to “Used”.
<ul style="list-style-type: none"> • INI exists at Customer. • Site Defaults “Create Internal Number Inventory at Customer” check box is clear. 	The lines in the INI at the Customer are updated to “Used”.
<ul style="list-style-type: none"> • No INI exists. • Site Defaults “Create Internal Number Inventory at Customer” check box is clear. 	The INI is created at the Site.
<ul style="list-style-type: none"> • INI exists at Customer. • Site Defaults “Create Internal Number Inventory at Customer” check box is selected. 	The lines in the INI at the Customer are updated to “Used”.
<ul style="list-style-type: none"> • INI exists at Site. • Site Defaults “Create Internal Number Inventory at Customer” check box is selected. 	The lines in the INI at the Site are updated to “Used”.
<ul style="list-style-type: none"> • No INI exists. • Site Defaults “Create Internal Number Inventory at Customer” check box is selected. 	The INI is created at the Customer.

The options available in the **Overbuild Action** drop-down are:

- **All Enabled Sites Using Settings Below**

- All selected devices on the **Run Overbuild** form are included.
- The Site Defaults Doc for each site contains an **Overbuild Defaults** tab. If the **Include Site for Overbuild** check box is selected, the site is included.
- An internal number inventory is created at customer level if the **Create Internal Number Inventory at Customer** check box is selected or at site level if the check box is cleared (if **Lines** are included).
- The Device Pools are from the **General Defaults** tab of the Site Defaults Doc and the Additional Device Pools from the **Overbuild Defaults** tab.
- The devices displayed when the **Limit Move Devices** option is selected on the **Overbuild Defaults** tab are ignored. Runs Overbuild for all sites, and uses the devices selected on the **Run Overbuild** form.

When the Run Overbuild tool executes with this option, it will apply to all sites and use the devices selected on the **Run Overbuild** form. Run Overbuild devices supersede the devices selected in **Limit Move Devices**.

- **All Enabled Sites Using Site Defaults Doc Overbuild Settings**

- Selected devices on the **Run Overbuild** form are hidden and ignored. All selected devices when **Limit Moved Devices** is chosen on the **Overbuild Defaults** tab of Site Defaults are moved.
- The site is included only if the **Include Site for Overbuild** check box is selected.
- An internal number inventory is created at customer level if the **Create Internal Number Inventory at Customer** check box is selected or at site level if the check box is clear (if **Lines** are included).
- The Device Pools are from the **General Defaults** tab of Site Defaults and the Additional Device Pools from the **Overbuild Defaults** tab will be used.

- **Single Enabled Site Using Settings Below**

- Overbuild is applied to the single site specified in the **Select Site** drop-down, which is exposed when this Overbuild option is selected.

Only sites that have the **Include Site for Overbuild** check box selected in the Site Defaults Doc are available in the drop-down.

- All selected devices on the **Run Overbuild** form are included.
- An internal number inventory is created at customer level if the **Create Internal Number Inventory at Customer** check box is selected or at site level if the check box is clear (if **Lines** are included).
- The Device Pools are from the **General Defaults** tab of the Site Defaults Doc and the Additional Device Pools from the **Overbuild Defaults** tab.
- The devices displayed when the **Limit Move Devices** option is selected on the **Overbuild Defaults** tab are ignored. Runs Overbuild for the selected site, and uses the devices selected on the **Run Overbuild** form.

When the Run Overbuild tool executes with this option, it applies to the selected site only, and uses the devices selected on the **Run Overbuild** form. Run Overbuild devices supersede the devices selected in **Limit Move Devices**.

Available device types include:

- Phones
- Phone Remote Destinations
- Users:
 - `device/cucm/User`
 - `device/hcmf/User` (only if HCM-F is installed)
- Device Profiles
- Remote Destination Profiles (RDP)
- RDP Remote Destinations
- Lines (a number inventory entry is also added for all `device/cucm/Line` instances that are in the system at the customer or site level)
- CUC Users
- Webex Teams Users
- Pexip Users
- Contact Center Agents

The specific device models that are affected by the Overbuild move, are:

- device/cuc/User
- device/cuc/UserPassword
- device/cuc/UserPin
- device/cuc/AlternateExtension
- device/cuc/ExternalServiceAccount
- device/cuc/SntpDevice
- device/cuc/SmsDevice
- device/cuc/PagerDevice
- device/cuc/PhoneDevice
- device/cuc/HtmlDevice
- device/cuc/Callhandler
- device/cuc/CallhandlerMenuEntry
- device/cuc/CallhandlerTransferOption
- device/cuc/Greeting
- device/cuc/MessageHandler
- device/cucm/Phone
- device/cucm/User
- device/cucm/DeviceProfile
- device/cucm/RemoteDestinationProfile
- device/cucm/RemoteDestination
- device/cucm/Line
- device/hcmf/User (only if HCM-F is installed)
- device/pexip/Conference
- device/spark/User
- device/uccx/Team
- device/uccx/Skill
- device/uccx/ResourceGroup
- device/uccx/Agent

Data models affected when the user is moved during Overbuild:

- data/User
- data/HCSHcmfUserDAT

The availability of certain device type check boxes depends on the status of other device type check boxes. For example, the **Dual-Mode Remote Destinations**, **Users**, and **Lines** check boxes are only available if the **Phones** check box is selected. The **Device Profiles**, **Remote Destination Profiles**, and **CUC Users** check boxes are only available if the **Users** check box is selected.

Overbuild workflows do not stop on any transaction failures and no transaction rollback takes place on errors. For example, device instance move operations to Sites continue for all selected devices. Inspect the transaction log for errors.

In the Transaction log, subtransactions of a successful overbuild workflow show their Status as “Fail” if a model (such as a User) already exists. The subtransaction logs also show details of the duplicate model and an “ignore error code” information message.

23.4.2. Objects that are Moved During the Overbuild

The overbuild processes the imported Unified CM objects for selected sites in the current customer. During overbuild, some objects are moved to the site hierarchy, while others remain at the customer hierarchy.

Objects That Are Moved to the Site Hierarchy

Unified CM models	device/cucm/Line device/cucm/Phone device/cucm/RemoteDestinationProfile device/cucm/RemoteDestination device/cucm/DeviceProfile device/cucm/User
HCMF (if installed)	device/hcmf/User
Cisco Unity Connection models	device/cuc/User device/cuc/UserPassword device/cuc/UserPin device/cuc/AlternateExtension device/cuc/SntpDevice device/cuc/SmsDevice device/cuc/PagerDevice device/cuc/PhoneDevice device/cuc/HtmlDevice device/cuc/CallHandler device/cuc/CallhandlerMenuEntry device/cuc/CallhandlerTransferOption device/cuc/Greeting device/cuc/MessageHandler
Voicemail related models	device/cuc/User device/cuc/UserPassword device/cuc/UserPin device/cuc/AlternateExtension device/cuc/SntpDevice device/cuc/SmsDevice device/cuc/PagerDevice device/cuc/PhoneDevice device/cuc/HtmlDevice
Self-care models	device/cuc/Callhandler. By default, one CallHandler entry is created when a Cisco Unity Connection user is created. device/cuc/CallhandlerMenuEntry

- [Contact Center Management](#)

After the initial sync, agents will be located at the customer hierarchy level. The overbuild tool will attempt to move these agents to the correct site hierarchy levels, based on matching Cisco Unified CM users. This matching is done according to the Unified CM user ID and the agent user ID.

Contact Center models	device/uccx/Team device/uccx/Skill device/uccx/ResourceGroup device/uccx/Agent
-----------------------	---

Data models affected when the user is moved during Overbuild:

- data/User
- data/HCSHcmfUserDAT

Objects That Remain at the Customer Hierarchy

Unified CM models	device/cucm/DevicePool device/cucm/Region device/cucm/Location device/cucm/VoiceMailPilot device/cucm/VoiceMailProfile device/cucm/Css device/cucm/RoutePartition device/cucm/HuntList device/cucm/HuntPilot device/cucm/LineGroup device/cucm/CallPickupGroup device/cucm/DirectedCallPark device/cucm/CallPark device/cucm/CtiRoutePoint
Cisco Unity Connection models	operator undeliverablemessagesmailbox
Call-Handler device models	Goodbye Opening Greeting Operator operator undeliverablemessagesmailbox
Call Pickup Groups	no objects moved

23.5. Overbuild Tool

23.5.1. Summary of the Overview Tool

Use the Overview Tool to validate your Run Overbuild process. Overbuild users can use individual device models to make sure that the required Unified CM elements have been moved to the right hierarchy.

Choose the **Overbuild > Overview Tool** menu option. It can be used at the Customer or Site hierarchy. The report shows the numbers of each Unified CM customer-specific data, for example phones, lines, users, etc. at the selected hierarchy and below. This is displayed in the format “current hierarchy/below.” For example, “390/20” means that 390 elements are at the current hierarchy and 20 elements are at hierarchies below the current hierarchy. Change the hierarchy to inspect the overbuild overview at that hierarchy.

When you run the Overview Tool at Site level, the number on the right will always show as 0, since Site is the lowest VOSS-4-UC hierarchy level.

To verify the individual device models after running Overbuild, choose **Overbuild > Device Model > (desired model name)**. The hierarchy where each device model instance exists will be listed in the right-most column in the list view of the device model.

23.6. User Phone Association

23.6.1. User Phone Associate Tool

VOSS-4-UC uses the associated or controlled devices value on the Unified CM user (Subscriber in VOSS-4-UC) to determine which phones are associated to that Subscriber.

This User Phone Associate tool will ensure that Unified CM phones in the system with the ownerID value set, are correctly associated to the Unified CM user (Subscriber) for correct association in VOSS-4-UC.

A common situation where this might be the case is in the event of phones synced in from an existing environment for Overbuild - where the ownerID on the phones were set, but were not associated from the Unified CM User perspective. The symptom to look for is when you do not see the phones under the Subscriber view, but that you think they are owned by the user - an indication that this tool needs to be run to correct the association.

Note: When adding phones and subscribers from *within* VOSS-4-UC, the phone-user relationship is bi-directional.

Perform these steps:

1. Navigate to the hierarchy of the Unified CM and choose it from the **CUCM** dropdown list.

The **Number of Phones that will be checked** value that is displayed is the number of phones on the Unified CM at the hierarchy that have been synced in to VOSS-4-UC and have an ownerID set, but cannot be found to be an associated device of any subscriber at the hierarchy or lower.

2. Click **Save** to run the tool. Subscribers will be searched on VOSS-4-UC that match the ownerID and if found, their associated devices will be updated with the phone.

If the tool is now re-run for the selected Unified CM and any of the checked phones were set as associated devices, the **Number of Phones that will be checked** value will decrease accordingly.

Note: If a subscriber already has other associated devices, any new associated devices will be appended to the existing list.

23.7. Overbuild Analog Gateway

23.7.1. Overbuild Analog Gateway

Overview

VOSS-4-UC offers management of analog gateways (FXS ports) using the SCCP and MGCP protocols. This feature also provides an overbuild capability.

VG2XX and VG3XX models are supported providing a range of port capacities from 2 – 160 ports. VG400 (8 ports max) and VG450 (144 ports max) models are also supported.

How Does this Feature Work?

This feature is initiated via the **Overbuild Analog Gateway** form (accessed via the default menu location **Overbuild > Overbuild Analog Gateway**).

The only required attribute is the **CUCM IP Address**, which is selected from a drop-down list. When executing the overbuild, all MGCP and SCCP gateways are discovered.

For each gateway not already at site level, a new IOS device is created, and the gateway and ports are moved to the site level based upon the device pool found on the first port. The gateway can then be managed in the normal way.

Note: Since the device pool associated with the first gateway port is used to identify the location of the gateway, a gateway with no configured ports cannot be moved.

23.8. Device Models

23.8.1. Device Models: Overview

With the Device Models menu item, you can view details about the devices by model in the selected hierarchy. Like the Overview Tool, this can be useful to help you see where devices have moved as a result of the Overbuild process. When you select a device model type in the menu, a table presents you data about the devices of that model type in the hierarchy: the device names or identifiers, their device pools, their hierarchies at and below the one currently selected, and other data that varies with the device model selected.

Within a device model, you can modify, delete, and export the individual devices by selecting them. Additionally, you can change settings all at once for all the devices in a device model by selecting the **Select All** check box, located at the top-left on the table header, and choosing **Action > Bulk Modify**.

Caution: We do NOT recommend that you directly edit the device models in this menu, but use the other menus in VOSS-4-UC such as the Subscriber Day 2 menus. The Device Models menu items should be used for manually moving device models that the Overbuild tool cannot move or that need additional manual moves after Run Overbuild is executed.

For CUC models, there are two system users, operator and undeliverablemessagesmailbox, which will remain at Customer level. All associated CUC device models for the two system users will remain at the Customer hierarchy and will show in the device model counts and device model lists at the Customer hierarchy.

For call handler device models, there are 5 default instances that remain at the Customer hierarchy:

- Goodbye (a CUC system default call handler)
- Opening Greeting (a CUC system default call handler)
- Operator (a CUC system default call handler)
- operator (the system user 'operator' call handler)
- undeliverablemessagesmailbox (the system user 'undeliverablemessagesmailbox' call handler)

These 5 call handlers remain at the Customer hierarchy and appear in the device model count and device model lists for call handlers at the Customer hierarchy.

These device models also allow you to add device instances. Note that adding device instances here in the Overbuild menu is not recommended.

- CUCM CtiRoutePoint
- CUCM DirectedCallPark
- CUCM Phone
- WebEx User

23.8.2. Find a User Associated with a CUC Device Model

The CUC device models use internal UUID references to the CUC user objects. As a result, most CUC device models do not have a field showing the ID of the user to which the device model is associated. The VOSS-4-UC search function can be used to find this associated user information.

Perform these steps:

1. Choose **Overbuild > Device Models**.
2. Click the desired CUC device model in the menu. A list of the CUC device models appears.
3. Click the desired device model instance.
4. In the CUC device model output, find the field Subscriber Object ID.
5. In the search box at the top right of the Admin Portal, type this string:

```
device/cuc/User WITH object_id like 9b16c8ce-edd9-43c4-9262-c25296d3560b
```

where 9b16c8ce-edd9-43c4-9262-c25296d3560b would be replaced with the output of the Subscriber Object ID.

The equivalent VOSS-4-UC API request would be:

```
https://<host-or-proxy>/api/tool/Search/?  
format=json&  
device%2Fcuc%2FUser%20  
with%20object_id%20like%20  
9b16c8ce-edd9-43c4-9262-c25296d3560b
```

24. Administration Tools

24.1. Import

24.1.1. Import: Overview

Model definitions and instances can be imported using JSON files. These can be compressed (`.json.zip`) or be uncompressed files with extension `.json`.

The format of the JSON files should correspond with the JSON schema for the model or instance that is imported. Typically, a model instance is exported as a JSON file in order to obtain such a schema. The export can then for example be edited as required.

For each model instance in a JSON file, if it contains the same values for a business key as an existing model instance, then the import will update the existing instance. Otherwise, the import will add a model instance. The business key of a model is specified on its design form and can be seen in the Add Form schema of the Model API Help Reference.

When exporting items that belong to a package, all hierarchy information will be removed from item meta business keys so that the packages have no hierarchy.

The importing process will still adhere to the hierarchy specified in the meta of each item except for a data/Package instance, which will be imported at the import hierarchy (breadcrumb hierarchy). For items other than Packages, the hierarchy where the items is loaded can be overridden (to the same or lower hierarchy level only) by specifying the hierarchy in the meta of the item.

If no hierarchy is found in the meta of the item, then the hierarchy will be taken from the import hierarchy (breadcrumb hierarchy).

24.1.2. Import a File

1. Choose the hierarchy level for the import (not applicable to packages - see [Import: Overview](#) for more details).
2. Access the **Import** form (default menu **Administration Tools > Import**).
3. Choose the file (`.json`, `.json.tar.gz`, or `.json.zip`) that you want to import. Wait until the file name is displayed on the form.
4. Click **Import** to import the file to the hierarchy.

24.2. Bulk Administration

24.2.1. Bulk Load Overview

The bulk loader tools enable the quick and easy management of system data using pre-populated MS Excel formatted spreadsheets.

A spreadsheet template can be generated by the system for any of the resources in the system - either from the Admin Portal or the API.

The data on the sheet includes column headers to indicate the hierarchy, action, search criteria and attribute names of the model to which the data applies. Rows include the data for model individual instances.

Note: To carry out a bulk load, the selected model should allow add operations in the Access Profile for the user.

Use a single sheet in the file to manage multiple templates by adding additional header rows and data under them. A file can include multiple sheets with a single or multiple templates on each.

When the file is loaded, it can either be processed immediately or scheduled for a date and time. A scheduled bulk load file is listed on the Schedule list view as a Single Execution schedule type and with resource type of data/BulkLoad. Items on the Schedule list are deleted once the scheduled item has been executed. This means that after a scheduled bulk load has been executed, you will no longer see it in the list of schedules.

A single parent transaction is created for the entire bulk load. Unless a sheet is set to execute rows in parallel, each row in the bulk load sheet results in a separate sub-transaction that is executed sequentially and synchronously. If a single sub-transaction fails, the bulk load transaction continues and does not roll back the preceding sub-transactions. In the case where a bulk load sub-transaction has other sub-transactions - for example a provisioning workflow with multiple steps - failure in any of the steps will cause a roll back of all the steps in the bulk load sub-transaction.

If a sheet is set to process rows in parallel, then by default, 14 rows are processed in parallel. Refer to the topic on the bulk load sheet layout for more details.

If a file is processed and further files are loaded, they are processed in parallel. Thus, bulk load transactions are executed in parallel, as with all transactions. Bulk load transactions are executed immediately.

Transactions, once started, cannot be canceled.

24.2.2. Data Export

Data can be exported in JSON format and as MS Excel spreadsheets.

The system JSON file format is used to Export and Import various operations on model instances. The operations available via JSON files are: Add, Modify, Delete. This Import and Export task is carried out from the Admin Portal or API using the file Export and Import functionality.

The JSON file format for the different operations is available when you **Export** a specific model and choose **JSON** as the export format. The API provides a request URL and parameter for this task - refer to the API documentation. The export file format is a compressed JSON file. The import filename and format can be <filename>.JSON, <filename>.JSON.zip or <filename>.JSON.gz.

The Excel file format for data export of selected items can be carried out in the list or instance view of a model.

Commands can be exported from the Admin Portal by choosing **Export** and then selecting either **Excel** or **Excel (formatted)** as the export format. The API provides a request URL and parameter for this task - refer to the API documentation. The export file format is a MS Excel XLSX file.

The Field Display Policy that applies to a menu item from which an Excel (formatted) export of data is carried out, is reflected in the Excel (formatted) exported sheet as follows:

- Titles of attributes
- Sequence of the attributes
- Group names
- Hidden fields, with the exception of mandatory fields.

24.2.3. Bulk Export of Model Data

1. Choose the hierarchy to which the model belongs.
2. Choose the items to be exported from the List view and click **Export**.
3. From the **Export format** list, choose the required export format and export the selected items. The following file formats correspond with the selected item in the list:
 - JSON - an export containing data in JSON format as in the system database. Item properties such as strings that are empty or Boolean values that are not set, are not included. The export filename also contains a date stamp.
 - Excel - an export containing data and Excel columns for all fields as shown in the JSON export format. The export filename also contains a date stamp and reference to the export data type.
 - Excel(formatted) - an export containing data and Excel columns as arranged by any Field Display Policies that apply. The columns correspond with those of a Bulk Load Template export sheet. This sheet can therefore be used to modify and update data if required. The export filename also contains a date stamp and reference to the export data type.
4. If required, the export JSON file can be decompressed, and the JSON file (.json) can be opened in a text editor. The XLSX file can for example be opened in MS Excel.

Note: The bulk export of Device Model data will export locally *cached* data, not data on the device itself.

24.2.4. Bulk Load Template Export

You can use the MS Excel format spreadsheet bulk load template of a model to easily create a template of a sheet from the user interface. See [Bulk Load Template Sheet Layout](#).

The VOSS-4-UC multi-domain core supports the ability to generate a MS Excel format spreadsheet bulk load template for any of the resources in the system directly from the user interface.

You can populate the template sheet with data and then load it using the Bulk Load administration tool.

Excel Bulk Load operations using spreadsheets support multiple (tabbed) worksheets that are loaded in tab sequence. Defined Configuration Templates on the system can be referenced in the sheets and applied during the Bulk Load operation.

The field specific help of the product can be used to assist the user with populating the bulk loaders with the correct data. See [Bulk Load Template Sheet Layout](#).

24.2.5. Carry out a Bulk Load Template Export

The export of a bulk load template of a model is available on the list view.

1. Choose the hierarchy where the model is available.
2. Choose the required form and choose the export option **Bulk Load Template**.

A MS Excel sheet is created that contains the bulk load template for the selected model. The sheet is available in the download directory of the browser application.

Use the bulk load template sheet to enter data.

Use the Bulk Load administration tool to upload the bulk load template sheet.

24.2.6. Bulk Load Sheets

An exported bulk load template is a workbook containing a single sheet and serves as the basis for bulk loading. A workbook can also be created that contains more than one sheet as a tabbed workbook.

For tabbed workbooks, bulk load transactions are carried out from the leftmost sheet or tab to the rightmost. For example, if a site is to be added under a customer, the customer sheet tab should be to the left of the associated site.

The spreadsheet workbook is in Microsoft Excel .xlsx format. Any name can be provided for the workbook and the same filename can be loaded multiple times, although the best practice is to use different names.

To bulk load data, preliminary steps need to be carried out. Verify existing information on the sheet and determine required information in order to complete the required data and prepare the spreadsheet.

24.2.7. Bulk Load Limitations

The VOSS-4-UC automation templates include a rich set of features that incorporate the use of Configuration Templates, customizable Field Display Policies and GUI rules that are used to enhance the user experience of the user interface.

Generated bulk load templates for certain resources that make use of such advanced features are limited in their ability to produce the same provisioning results that can be obtained when using the user interface and as such require additional consideration.

An overview of these limitations is provided below, whilst the implications of these limitations, how they may apply to specific resources in the system as well as how best to use the generated loaders, are documented in the Bulkload Reference Guides under resource specific sheet notes.

- Certain fields are used to link together different resources.

These fields may not be exposed in the user interface or may, for some resources, be exposed as read-only in the user interface. Such fields are currently exposed as mandatory fields in the generated bulk load templates. The fields and the specific conventions that are used in the template to link the fields together are highlighted in notes specific to the resource. For example, the value for remote destination name should be specified as `RDP-<username>`.

- Certain fields are derived from other data in the system. The notes specific to the resource highlights where to get the possible values for such fields. Examples of this are key-value type fields of a phone's vendor configuration settings.

- GUI Rules defined in the user interface that are not replicated in the backend workflow need to be considered in the loader to get the same provisioning results as the GUI. For example, the GUI rules may:
 - Set a default value for a visible field (fixed value or derived from other data in the system). This column and corresponding value will have to be included in the loader for this to be provisioned.
 - Set a value for a hidden field - This column and corresponding value will have to be included in the loader for this to be provisioned. Note that this means that fields may be included in the loader that would not be visible in the user interface.
 - Make a field visible depending on some condition such as the value of another field (for example, a check box being selected). The column(s) need to be included in the loader and populated under the appropriate conditions.

A GUI Rule may for example disable input fields based on the state of a check box. On the sheet, the ticked check box is represented as TRUE in the column. The columns associated with the disabled fields should not be filled.

	Y	Z	AA	AB
1				
2	forwardHuntNoAnswer_destination	forwardHuntNoAnswer_usePersonalPreferences	forwardHuntNoAnswer_callingSearchSpaceName	forwardHuntBusy_destination
3				
4	# Destination	# Use Personal Preferences	# Calling Search Space Name	# Destination
5		TRUE		

To overcome the complexities introduced by the above limitations, a set of sample bulk load sheets have been generated that enable users to get started quickly and to leverage the best practices developed by VOSS.

24.2.8. Sample Bulk Loaders

Sample loaders enable a quick start by providing working examples of the most frequently used loaders. These can be customized according to user requirements and data.

Furthermore, sample bulk load sheets incorporate best practices for using bulk loaders; ensuring rapid customer and subscriber on-boarding.

Note that the sample loaders are built according to the default Field Display Policies and Configuration Templates that are shipped with the product. Since these are configurable, the use of non-default Field Display Policies or Configuration Templates may result in a change of the sample loaders. For example, if an additional field is exposed by the Field Display Policy, it needs to be added if it is to be managed in the loader.

The latest sample bulk loaders can be obtained from your account team.

24.2.9. Bulk Load Template Sheet Layout

This topic describes a typical generated sheet when using the Export Bulk Load Template menu option.

Colors and styles are applied to the exported sheet:

- dark colors style for header rows
- yellow text for base group titles
- mandatory fields have red title text headers
- optional fields text headers are in white

Although an attribute that has nested attributes may be optional, if this attribute has mandatory nested attributes, then the containing attribute becomes mandatory. If a field is mandatory, it is shown on the sheet regardless of any Field Display Policy instruction to hide it.

The Field Display Policy that applies to a menu item from which a Bulk Load Template Export is carried out, is applied to the exported sheet as follows:

- Titles of attributes
- Sequence of the attributes
- Group names
- Hidden fields, with the exception of mandatory fields.

Note:

- Macros can be included in the loader to either be loaded as text or evaluated as part of the load. See documentation in this guide around *evaluate_macros* header for more details on macro behavior in the loaders.
- A single sheet of a file can be used to manage multiple templates by adding additional header rows and data under them. A workbook file can include multiple sheets with single or multiple templates on each.

\$hierarchy	\$action	\$search_fields	\$device	\$template	\$ndl	\$pkid	pattern	name
# Base							# Hunt Pilot Pattern	
Comment	Hierarchy	Nod#	Action	Search	Fiel	#	Device:FT	Templa
Network	Device	Li#	Unique	Identifie	#	Hunt	Pilot	Pattern
#	Name							

Refer to the example sheet snippet. A bulk load sheet contains the following information:

Sheet name (tab on spreadsheet workbook)

Any name can be provided on the tab or sheet. If the name is prefixed with a # on the tab, the sheet is ignored during loading.

Row 1 - Resource and instructions

The exported bulk loader template will have the resource as target entity (model) as well as the hierarchy shown on the top row of the sheet. Verify the entity in the first row of an exported sheet. The reference data in the first row is of the format shown below, with variable values indicated in {}:

```
entity: {entity name}; \
hierarchy: {hierarchy}; \
parallel: {True | False}; \
parallel_transaction_limit: {n}; \
template: {config_template}; \
meta_prefix: {c}; \
evaluate_macros: {True | False}
```

- *entity: {entity name}*: the name of the model, in the format *{modeltype}/{model name}*, for example *data/User*
- *{hierarchy}*: the hierarchy, in the format *{level1}.{level2}.{level3}*, where *{level1}* is the first system level. Verify the hierarchy at which the bulk load should take place.
- *parallel*: True or False. By default, the value is False and rows are processed sequentially. If multiple templates are entered on a single sheet, they should all *only have a single value*: True or False.

Sheet rows can be processed in parallel. The sheet should then not contain multiple, sequence dependent models. If there are a large number of rows for complex models on the sheet, the duration of a bulk load transaction is significantly reduced by parallel processing.

By default, 14 rows are processed in parallel, since bulk loads are low priority transactions that are limited to 50% of the maximum allowed parent transactions, which is by default set to be 30 per unified node. The default value supposes that one slot is used by the parent bulk load transaction itself.

The maximum allowed parent transaction limit can be modified from the Command Line Interface (CLI) using the command: **voss workers <number>**.

- *parallel_transaction_limit*: the maximum number of rows that can be processed in parallel by the bulk load at any given time. The minimum value that can be set is 1 and the maximum is 100.
- *template*: The Configuration Template *{config_template}* that is associated with the user's menu item for the *{entity_name}* from which the export was carried out. The exported sheet will show a row of values from the Configuration Template.

When a sheet is created to bulk load, the Configuration Template should be available on the target system and it will only apply to rows on the sheet that has **add** specified in the # *Action* column.

Note: this header item is not used when Configuration Templates are loaded.

- *meta_prefix*: By default, the value is \$. The # character cannot be used, as it is used for comments. The character is prefixed to the # *Base* group of columns in Row 2.

The purpose of the prefix is to distinguish a special set of base columns from the entity attributes on bulk load sheets.

Note that the bulk load sheets will fail to load if the # character is used as prefix. An error message will be shown in the transaction log.

- *evaluate_macros*: By default, the value is False. When set to True, named macros can be added as values to be evaluated before the sheet is loaded. Otherwise, the value is a string.

The format of the macro is *{{ fn.bulkload_evaluate macro.NamedMacro }}*, where *NamedMacro* is the name of an existing *data/Macro* instance. The function prefix *fn.bulkload_evaluate* is required in the value for the macro to be evaluated.

- For examples, see *Bulk Load Sheet Macro Evaluation*.

Note: `fn.bulkload_evaluate` is not available via the Macro Evaluator. For testing purpose using the Macro Evaluator, please use the `fn.evaluate` function prefix.

Base columns (grouped by # Base in Row 3)

The list below describes the column values with the default value of `meta_prefix`, in other words, column names by default prefixed by `$`.

The purpose of the columns is to provide more detailed instructions or overriding data for a row.

- **Comments:** Any row that contains a `#` character in column A is considered a comment row and will be ignored. Empty rows are also ignored. Column A - the first column - is also a `# Comment` column, so that any value entered in it is considered a comment. If all rows on a tab are commented, but the tab name itself is not commented, the tab sheet load will fail.
- **\$hierarchy:** A hierarchy column with the name `# Hierarchy Node` is also available so that individual rows of a sheet can be loaded to a specified hierarchy. If a hierarchy is specified in this column for the row, it takes precedence over the hierarchy in the first row. The format for the hierarchy in the row is the same as for the first row: the full hierarchy, with levels separated by dots.
- **\$action:** Any row that contains an action in the `# Action` column : **add**, **delete**, **modify**, **execute** or a custom action name, will have the action carried out. The action values in the column are case insensitive.

If no action is entered, the **add** action is carried out. The list below shows the functionality for the values entered in the row. Also refer to the Search Fields entry below.

- **add** or empty - the data in the attribute columns is added. Any values in the `# Search Fields` column are ignored.
- **delete** - the row matching the unique criteria in the `# Search Fields` column is deleted.
- **modify** - the row matching the unique criteria in the `# Search Fields` column is updated with values in the attribute columns. Refer to the Search Fields entry below.
- **execute** - if the action is available for the model, the row matching the unique criteria in the `# Search Fields` column is executed, using any values entered in attribute columns.
- custom action name - if the custom action is defined for the model, it is carried out for the row matching the unique criteria in the `# Search Fields` column.
- **\$search_fields:** The column applies to rows where the action is not **add** and consists of a colon-separated list of attribute names and values, for example, `fullname:'John Smith', username:jsmith`.

Note however that the `pkid` field takes precedence over search fields criteria.

- **delete** - the search fields and corresponding attribute values uniquely identify the model instance to delete.
- **modify** - the search fields and corresponding attribute values uniquely identify the model instance to modify, with the values to modify in the attribute columns.
- **execute** - the search fields and corresponding attribute values uniquely identify the model instance to execute.

Where the sheet is for a Relation model, only the left model attributes in the Relation can be in the Search Fields column. This is the standard search behavior for Relations.

- `$device`: The column is used when a sheet includes attribute columns that belong to a device model. This column then contains the comma-separated list of business keys of the device model, as well as its hierarchy. These values narrow the search for the device to which the data in the sheet applies. Examples of such sheets would contain device models or relations that have device model attributes in the left hand association of the relation.

The format of the values in this column is:

```
<business_key1>,<business_key2>,...,<business_keyn>,<device_hierarchy>.
```

For example, if a CM instance in a model `data/CallManager` has `host` and `port` as business keys, the value would for example be: `10.120.2.175,8443,sys.Varidion.InGen.Tokyo`.

- `$template` (Configuration Template): If a row that contains a Configuration Template name that applies to the model, this template is applied to the row when it is loaded. Upon bulk loading, values in this column will override any value for `template` in the sheet header.
- `$ndl` (Network Device List): The column is used when a sheet includes attribute columns that belong to a device model. This column then contains the name of the Network Device List that includes the required device in the list of devices. The NDL can be filled in as either the business key friendly name or in the NDL business key format, for example [`"322-CL1-NDL"`, `"hcs.MTLAB.Ops.IBM"`]. The friendly name (`"322-CL1-NDL"`) will then be used during the bulk load.

If the Device column is also filled in, then the value in the Network Device List column overrides it.

- `$pkid` (Unique Identifier): On modify, delete, execute, and custom action operations, this `pkid` is used to identify the resource represented in the row data. The `pkid` field takes precedence over the search fields criteria when locating a resource. The `pkid` is unique to the resource on the particular database and cannot be relied upon when attempting to manipulate an identical resource on a different database.

Note: Macros inserted into the Base columns will not evaluate. See: [Bulk Load Sheet Macro Evaluation](#).

Row 2 - Column names

- base column names (prefixed by the `meta_prefix` character and listed above)
- attribute names. Entity attribute names show as column header data in the spreadsheet.

Columns can be in any order in a row. Nested object attribute names follow a dot notation.

Array objects will be sorted, so that attributes with names such as `filter_fields.<number>.xx` will be in sequence: `filter_fields.0.xx`, `filter_fields.2.xx`, and so on - before further ordering (represented by `.xx` here) is applied.

- If a column header starts with a `#`, the column will not be loaded.
- If a column header is blank, this indicates the end of the sheet header. Subsequent columns will not be loaded.

entity: relation/HuntGroupRelation; hierarchy: sys; parallel: False; parallel_transaction_limit: ; template: ; meta_pref																
Hierarchy	Section	Search_fields	Device	Template	ndl	pkid	pattern	name								
# Base					# Hunt Pilot Pattern											
# Comment	Hierarchy	Nod	Action	Search	Field	# Device_FT	Templa	Network	Device	Li	Unique	Identifie	# Hunt	Pilot	Pattern	# Name
	sys.Provider1Customer52													33121		
#	svs.Provider1Customer52													33122		

Row 3 - Group or description

The row provides a description of a column or columns (as for example # `Base` for the sheet base columns), or else the group name of attributes that are grouped on the GUI as tabs on the detail or input GUI form.

A group is specified in the row by merging the group name across all the columns of the group. For attributes that are required and are not grouped in the GUI (or may be hidden in the GUI), the group name: Not Grouped Fields is given on the sheet.

“Default” values of attributes in this group need to be removed from an exported sheet before the sheet is used to bulk load rows.

Row 4 - Title

Title of:

- the reference for base column names (hierarchy, action and so on)
- the column attribute as on the GUI. This title may be modified by a Field Display Policy.

Data rows

The exported template contains no data.

Important: As a part of bulk loader sheet design, attention should be paid to the API payload posted to the system. The data entered in the loader sheet columns should correspond with the API payload.

GUI drop-down lists may contain user-friendly titles, while the actual value sent to the API may differ.

24.2.10. Export Data Sheet Layout

This topic describes an exported sheet, either formatted or not formatted.

For both exported sheet formats, the header and column layout shows correspondences with the Bulk Load Template sheet.

The following items apply to sheets containing data exports:

- The # `Comment` column shows the text “Exported data” in green for each row of data.
- The # `Hierarchy Node` column shows the source hierarchy of the exported row. The `hierarchy:` value in the sheet header shows the hierarchy from which the data export was run.
- If device instances were exported, the # `Device` columns shows the business key of the device (for example, comma-separated: host, port, hierarchy).
- If a Configuration Template was applied during the export - for example if it applied to the Admin Portal form - # `CFT Template` column will show this name for each row, as well as the `template` value in the sheet header. If a sheet is used for loading, the row value overrides the sheet header value.
- The # `Unique Identifier` contains the `pkid` that is used to identify the exported resource represented in the row data. On modify, delete, execute, and custom action operations, this `pkid` is used to identify the resource instance on the database represented in the row data.

The `pkid` field:

- takes precedence over the search fields criteria when locating a resource

- is unique to the resource on the particular database and cannot be relied upon when attempting to manipulate an identical resource on a different database
- For a formatted Excel export, the columns in the sheet correspond with an exported Bulk Load Template sheet.
- For a non-formatted Excel exported sheet, the columns correspond with the properties of an exported JSON file. For example, only properties where strings are not empty and boolean values are set, are exported.
- A formatted, exported sheet of data can be used just as a Bulk Load Template sheet to bulk load data. For other Actions, the # Search Fields column needs to be completed. Refer to [Bulk Load Template Sheet Layout](#).
- “Default” values of attributes in any Not Grouped Fields group need to be removed from a sheet before it is used to bulk load rows.
- The rows and data in the columns of an exported sheet are bound by the limitations of the MS Excel format. For example, model data with property values longer than 32,767 characters (maximum length of MS Excel cell contents) will be truncated in the exported sheet.

24.2.11. Bulk Loading a File

Completed Bulk Load XLS sheets can be loaded immediately. Verify the following:

- Ensure that:
 - The file has a valid file extension `.xlsx`. An error message will display on the user interface to indicate that the file does not have a valid file extension.
 - Any Configuration Templates that are referenced, are available.
 - Any comments that your spreadsheet application allows you to add (for example showing as a marker in the cell with a pop-up) have been removed. Otherwise, an error message is shown: “An error occurred while opening the workbook. For possible resolution, please remove all comments from the worksheets and try again. If the problem persists, contact your administrator for support.”
 - To send *empty values* for a field, two options are available:
 - Type a space in the cell of the value column on the sheet.
 - Type `<NULL>` in the cell of the value column on the sheet.
 - Spreadsheet formulas (such as `'=7+2'`) in data will not be evaluated.
1. Browse to the hierarchy level at which you want to perform the bulk load.
 2. Open the **Bulk Load** form (default menu **Administration Tools > Bulk Load**).
 3. Browse to the file you want to bulk load and click **Bulk Load**.
 4. Go to the **Transaction** menu to inspect the bulk load in the transaction log if necessary. The **Execute Bulk Load** sub-transaction list shows the transaction for each row of the sheet.
 5. Alternatively, to schedule the bulk load, clear the **Execute Immediately** check box and add scheduled date and time values in the mandatory **Execution Date**, **Execution Time** and **Execution Timezone** fields. A scheduled bulk load is shown on the list view of the Schedule and has the name and upload load date of the sheet.

24.2.12. Bulk Load Sheet Macro Evaluation

Bulk load sheets can be configured to allow for macro evaluation.

The first row of a bulk load sheet has a variable to enable or disable macro evaluation (see [Bulk Load Template Sheet Layout](#)):

```
evaluate_macros: {True | False}
```

- If the variable is set to `True`, macros in a sheet will be evaluated upon loading. In this case, it is important that:
 1. The macro be prefixed with `fn.bulkload_evaluate`.
 2. A named macro must be used, in other words, a `data/Macros` instance.
 3. If the named macro that is used evaluates to a boolean or integer value, it will be evaluated and the sheet will be processed with that value.

For example:

1. If the sheet is used to update a site at its hierarchy, and the `evaluate_macros`: value is set to `True` in the first row, then:
 - The macro `{{ fn.bulkload_evaluate macro.SITENAME }}` will be evaluated to the site name when the sheet is loaded, but inserted as plain text.
 - The macro `{{ fn.evaluate macro.SITENAME }}` will be *not* evaluated to the site name when the sheet is loaded, but inserted as plain text.
 - The macro `{{ macro.SITENAME }}` will be *not* evaluated to the site name when the sheet is loaded, but inserted as plain text.
 - The macro `{{ input.sitename }}` will be *not* evaluated to the site name when the sheet is loaded, but inserted as plain text.
 - Rows containing entries with a *combination* of the type `{{fn.bulkload_evaluate <named macro> }}` and other types macros will *only evaluate* the former type and load others as plain text.
 - Macros (in any format above) entered into the Base columns of a sheet will *not* evaluate - for details on the Base columns, see [Bulk Load Template Sheet Layout](#).
2. If the sheet is used to update a site at its hierarchy, and the `evaluate_macros`: value is set to `False` in the first row, then *all* macros entered will be inserted as plain text.

Note: If the named macro needs to be tested with the macro evaluator, the format is `{{ fn.evaluate macro.SITENAME }}`.

- See the topic on macros in VOSS-4-UC documentation for named macro examples.
- For further details, also refer to the Advanced Configuration Guide and Named Macro Reference.

24.2.13. Bulk Load Transactions

The transaction log is available on the user interface after a bulk load transaction has been run. Refer to the topics on transactions and viewing transactions in the documentation.

Go to the **Transaction** menu. Bulk load transactions show in the log:

- In the list view, the bulk load is shown in the Action column of the log. If the bulk load was scheduled, this is shown as a schedule with the detail column indicating it to be a bulk load. The Action column will show “Execute Bulk Load” or “Execute Schedule” respectively.
- The submitted, start and stop time for the entire bulk load transaction is also shown.
- The Detail section will hold the name of the file that is bulk loaded as well as the workbook sheet number and the number of successful rows out of the total, for example:

```
[ 8/9 ] succeeded from [ 1 ] sheet in data_Users_bulkloadsheet.xlsx.
```

Checks are made to validate the user’s access profile, the provided hierarchy information and data constraints for the bulk load transaction when updating the target models. The parent bulk load transaction will show the error message if this validation fails and no rows will be loaded.

Where rows are loaded, each row in the bulk load sheet appears as a sub-transaction within the bulk load transaction. The Message box shows the number of successful and failed rows loaded.

For each loaded sheet, bulk load transactions are run in series for each row. Multiple bulk load sheets can be loaded and these transactions will load in parallel.

Sheet rows can be processed in parallel. The sheet should then not contain multiple, sequence dependent models. Refer to [Bulk Load Template Sheet Layout](#).

For each row of the bulk load sheet carrying out the default add action, a Create action is shown on the list of transactions. Sheet rows that led to a successful Create action have a Success status, while rows that failed show a Fail status. If a row fails, the load process continues. For failed actions, the transaction can be selected to show the error message.

If one or more rows of the sheet failed to load, the Bulk Load Sub Transaction shows a Success status, while the Log list will show “error” for failed rows.

On the list of sub transactions, you can inspect the details of each sub transaction. For example, the submitted, start, and stop time for the bulk load sub transaction corresponding with a row on the bulk load sheet is shown. In the case of a failed sub transaction, further information about the failure - such as the error message and row data - is shown in the sub transaction.

A canceled bulk load transaction means the Processing worksheet sub transaction, as well as all sub transactions within the worksheet transaction in a Processing or Queued state, will fail.

For parallel transactions, multiple resource transactions may be in a Queued or Processing state. By default, 14 rows are processed in parallel. Refer to [Bulk Load Template Sheet Layout](#) for more details. If a worksheet transaction fails as a result of bulk load transaction cancellation, subsequent worksheet tabs in the bulk load workbook will not be processed by the bulk loader.

24.3. Alerts

24.3.1. Alerts

Administrators can view alerts at the hierarchy level at which they are logged in, and the levels below that hierarchy. For example, if an alert is raised at the customer level, for example *sys.hcs.provider.reseller.customer*, then the provider, reseller, and customer administrators can see that alert but not site administrator. A Site administrator doesn't have access to view the alert. All administrators have read and delete permissions to the alerts.

When an alert is raised, the messages or notifications indicator on the **Messages** button will show this. Clicking the button will show a message that alerts have been raised: "There are one or more alerts. Click here to view them." When clicking on this message, the user is directed to the list of alert messages.

The Alerts list can be viewed and managed on the Admin Portal from the **Alerts** list view (default menu **Administration Tools > Alerts**) or by clicking **Messages** on the top menu bar.

The Alert list is summarized by:

- **Category:** A specific category to which the alert belongs, for example: "Device Change Notification Collector/CallManager".
- **Code:** an error or warning code associated with the alert.
- **ID:** A reference to the source of the alert. Alerts with the same ID and code will update the count of this alert as well as the last time that the alert occurred. This means that a single alert is shown on the list for each alert with the same ID and code.

Administrators can also filter alerts by any of these fields.

When features are enabled to send alert messages, these are recorded in the list. Each alert also has such properties as a severity (Error, Warning or Info), the number of times that the same alert has been raised and the time stamp of the last alert instance.

Alert messages can be inspected and then acted upon by the administrator. If an issue that raised the alert has been resolved, the administrator can delete the alert from the list. If no alerts are present in the list, no notification is shown.

24.3.2. Alert Types and Alert Field Reference

For alert codes also see:

the Error Messages topic in the Platform or API Guides and SNMP Traps in the Platform Guide.

Database Maintenance Alerts

If database maintenance schedules have not been set up from the Command Line Interface (CLI), alerts are shown *at the provider level hierarchy* for each required schedule.

The schedules are required to periodically:

- Archive or delete database transaction logs (CLI: **voss transaction archive** or **voss transaction delete**)

Refer to the Platform Guide topic "Enable Database Scheduling " for details.

The format of the alert is:

- ID: A generated identifier:
 - TRANSACTION_DATABASE-<hostname>

Note: The <hostname> will be a primary unified node. These are where alerts are generated.

- Code: An error or warning code associated with the alert. (-1)
- Alert category: Database Maintenance
- Severity: Warning
- Message:
 - TRANSACTION DATABASE MAINTENANCE NOT SCHEDULED
- Count: Displays the number of times the alert has occurred.
- Latest Alert: Displays the last time this alert occurred.

Alert Code	Alert ID	Alert Category
-1	TRANSACTION_DATABASE-<hostname>	Database Maintenance
-1	CACHE_DATABASE-<hostname>	Database Maintenance

Licensing

Alert Code	Alert ID	Alert Category
36200	Hierarchy Resolution Failure	Licensing
36100	License Audit File Transfer or data/SmtpDestination, data/HttpDestination, etc.	License Audit File Transfer

Change Notification

Alert Code	Alert ID	Alert Category
calling exception code: 40000-40006, 40008	device pkid OR business key	Device Change Notification Collector <model type>

Alert Field Reference

- The field Title is indicated in bold. An asterisk * indicates the field is mandatory.
- If the field Type is an array, its the Field Name has a .[n] suffix, where n is the array index placeholder.
- Object and array names are listed to provide the context of fields.
- If a field belongs to an object or an array, the full name is in dot separated notation.
- Where cardinality is shown, the range is [MinItems..MaxItems].
- If a field has a Default value, the value is shown.

- If a field has a Pattern, the regular expression pattern is shown.

ID *	
Field Name	alert_id
Description	The unique ID of the alert
Type	String
Code *	
Field Name	alert_code
Description	The code of the alert
Type	String
Category *	
Field Name	alert_category
Description	The category of the alert
Type	String
Severity	
Field Name	alert_severity
Description	The severity of the alert
Type	String
Choices	["Error", "Warning", "Info"]
Message	
Field Name	alert_message
Description	The message describing the alert
Type	String
Count	
Field Name	alert_count
Description	The number of times this alert has occurred
Type	Integer
Latest Alert	
Field Name	alert_timestamp
Description	The last time this alert occurred
Type	String
Format	date-time

24.4. Transactions

24.4.1. Transaction Logging and Audit

Activity on the VOSS-4-UC system results in transactions that are recorded. The **Transaction** list view provides auditing information for each transaction.

View specific transaction details by clicking on a transaction. The **Back** button on the button bar (or the **See all transactions** link on the transaction details screen) can be used to navigate to the previous screen, for example from the parent transaction screen to the list view of all transactions.

Details

Information recorded includes data such as:

Info	Details
Transaction ID	Identifier of the transaction.
Action	The type of action recorded in the transaction, for instance Execute, Create, Modify, Data Import and so on.
Detail	A brief description of the processed transaction.
User	The user who initiated the transaction.
Priority	The priority of the transaction, for example Normal.
Status	For running transactions, this is In Progress; for completed transactions it is Fail or Success.
Message	The message displayed upon completion of the transaction.
Submitted Time, Started Time and Completed Time	The date and time indicating the transaction progress.
Submitted on Node	The host name of the application node that scheduled the transaction. On a clustered system, this can differ from the 'Processed on Node' name below.
Processed on Node	The host name of the application node that processed the transaction (this value will only be set once the transaction is processed). On a clustered system, this can differ from the 'Submitted on Node' name above.
Rolled Back	Indicates whether the transaction was rolled back or not.
Duration	The duration of the selected transaction. If there are sub-transactions, this parent transaction duration is the total duration of the transaction. This includes the total duration of import transactions that carry out provisioning workflows asynchronously.

On the Admin Portal, details of a specific transaction are displayed when the transaction is selected from the list view. Refer to [Bulk Load Transactions](#).

When a transaction is selected, the **Base** tab shows details of the columns of the transaction list view. The button bar on the detail list view shows **Help** and **Refresh** buttons if the transaction is still running. If the transaction is running, click the **Refresh** button to update the Progress field.

Lists of transactions can also be filtered. Refer to “Filtering Lists” for details.

Cancel

If you want to cancel a transaction while it is still running, click the **Cancel** button. If a transaction, with sub-transactions, is canceled, the sub-transaction currently in progress will complete. This sub-transaction as well as all preceding sub-transactions will then roll back to their previous states. Note that bulk load transactions do not follow this behavior. Each bulk load sub-transaction is seen as a main transaction, and only the ‘in progress’ sub-transaction will roll back to its previous state.

Replay

A **Replay** button is available if the transaction is complete. A transaction can be replayed if required, for example if a transaction failed because a target system service was not running. The replay of the transaction can then be used instead of re-entering data on an Admin Portal form.

Edit and Replay

An **Edit and Replay** button is also available for completed transactions. This is similar to the **Replay** button, but allows you to first make changes to the previously submitted form before the transaction is resubmitted.

The button is available for transactions that did not originate from bulk loads, or pop-up forms.

Edit and Replay opens the original input form that resulted in the transaction. The form also contains the original data that was posted. This data can be edited and the form can be submitted to replay the transaction. This functionality can therefore be used to for example edit a failed transaction or to modify data of a successful transaction.

Since GUI Rules apply to a form from a specific hierarchy, the Edit and Replay functionality should only be used from the same hierarchy as the original transaction was executed.

Note:

- Replay and Edit and Replay functionality are not supported by the bulk loader, because the bulk load files are not stored by default. The bulk loader extracts data from the spreadsheets and then performs the necessary action(s). The only time a bulk load file is stored in the database is when the bulk load is scheduled. In this case, the bulk loader keeps the file until it is triggered by the scheduler to execute the actions in the file. When the data is extracted from the file, it is deleted.
- When using Edit and Replay for a failed Quick Add Subscriber transaction, the following user information fields will not automatically update when changing the Username field:
 - Entitlement Profile
 - Firstname
 - LastName
 - Email

These need to be edited manually.

Sub-transactions

If a transaction has sub-transactions, a sub-transaction list is available on the form with links to their details. The sub-transaction form displays a link to a parent transaction.

Failed transactions show a Message of the error. However, a sub-transaction with a Create action that has a “fail on error” workflow condition for *duplicates*, may show its Status as Fail when not creating a duplicate, while the parent transaction then shows its Status as Success.

For asynchronous transactions and sub-transactions, refer to Parent and Sub-transactions for Asynchronous Transactions.

Logs

The Logs section displays a time stamp, Message and Severity details of transactions.

If the Severity has the status of `error`, the Message section can be expanded to inspect the error, and optionally copy it and send it to Support.

If a workflow is inspected, a separate log entry provides details of each step with a log message as *Step n*, starting with Step 0.

Resource or Record

Depending on the transaction type, an option is available to navigate to the original record where a resource changed.

24.4.2. Parent and Sub-transactions for Asynchronous Transactions

Parent and sub-transactions for asynchronous transactions are shown in the transaction logs as follows:

- Parent transactions are in a “Processing” state until the last asynchronous child transaction completes (with either “Success”, “Success With Async Failures”, or “Fail”). These include:
 - Asynchronous workflows triggered by Device Import
 - Asynchronous operations triggered by Bulk Load (with `parallel = true`)
 - Asynchronous workflow steps
- Asynchronous transactions for non-bulk operations are not grouped under the parent transactions. These include:
 - Asynchronous device import triggered by DataSync execute
 - Asynchronous event execute triggered by another operation
- The status of top level transactions with failed asynchronous at any level of sub-transactions is “Success With Async Failures”. The detail view of the top-level transaction also shows the list of failed async transactions below the list of sub-transactions. This list allows for easy access to all failed async transactions. The Detail column of the sub-transactions also show the number of failed async transactions.
- The details of parent transactions with the status “Success” also show the number of failed sub-transactions for the following:
 - Device Import

– Workflows

24.4.3. View a Transaction

You can only view transactions that are relevant to your specific hierarchy level. For instance, if you are logged into the system as a Customer Administrator you will be able to view all transactions that were performed at the customer for which you are the administrator. This includes transactions that were performed at any of the sites that belong to the customer. If you are logged in as a Site Administrator you will be able to view only the transactions that were performed at your specific site. Refer to the topic on Data Partitioning in the Core Feature Guide and to the API Guide to view transactions by means of the API. The steps below can be followed on the Admin Portal.

1. Choose **Administration Tools > Transaction**.

By default, the **Transaction** list view shows all parent transactions in progress or executed. This is indicated in the **Status** column of the list.

If you also want to see the child transactions (sub-transactions) in the list view, select the parent transaction. The list view shows both parent and sub-transactions.

For completed transactions, the **Status** column displays either **Success**, **Success With Async Failures**, or **Fail**. Failed transactions are highlighted in red by default, but this can be overridden in the Theme if required. An exclamation icon is also displayed next to the word **Fail**.

The **Detail** column provides additional details on the transaction if available. See “Transaction Details” for more information.

2. Click an individual transaction or sub-transaction (if required) to show a detailed view. If the top-level transaction has the status **Success With Async Failures**, the list of failed async transactions show below the list of sub-transactions. The failed async transactions can be at any level below the top-level transaction. Click the transaction to see the details of the failed async transaction(s). The **Detail** also shows the number of failed async transactions.

24.4.4. Transaction Log Levels

For users that have access to the `data/Settings` model or `view/DataSettings`, the global levels of logging can be managed.

This level will affect the Log block of messages at the bottom of a selected transaction on the Transaction interface and does not for example affect the transaction or sub transaction Action and Detail information.

Log levels are *cumulative*, in other words, more detailed levels include all details from less detailed levels. The levels includes messages and have severity values as follows:

Level	Description	Severity
Disabled	disables all transaction log messages	999
Error	only displays error messages	40
Warning	also adds warning messages to above	30
Info	also adds informational messages to above	20
Verbose	also adds messages used for diagnostic purposes to above	15
Debug	also adds advanced diagnostic messages - for future use	10

- The Severity values are referenced (from value - to value) in transaction details when the log level is changed on this setting or changed by lower level administrators from the **System Settings** menu. See: [Manage System Settings](#).
- If a transaction fails, the Log block will include all entries with severity values larger than that of the default or selected level of logging.
- The log levels of data syncs can be set to override these global levels.

The transaction log level used for data sync and its immediate sub-transactions is by default set to Warning when it is not set.

For details, refer to the Create a Custom Data Sync topic in the Core Feature Guide.

24.4.5. Transaction Details

This Detail column of the list of transactions in the transaction log user interface shows information according to the type of entity and the operation carried out by the transaction.

The rules listed below should be considered when creating a transaction filter and specifying the value of the filter text.

The following conditions apply to content in the Detail column:

Action	Entity	Comment
Create, Update, Clone and Delete	all models	Detail will only contain the name on the model
Execute	DataSync, Workflow, Event, Scheduler	Detail will contain the instance name
Bulk operations on Modify, Delete, Move	all models	<ul style="list-style-type: none"> • The parent transaction detail contains: “[no. of succeeded / no. of total] were [updated / deleted / moved to destination_hierarchy] successfully.” • Bulk move from different hierarchies to one hierarchy show the destination hierarchy name in the parent transaction detail. • Each child transaction detail will contain the name of instance that is deleted.
Data Import	all models	Detail shows only the imported file name.
Device Import	all devices	Detail shows host name or device address
All operations	all models	The following attribute values are considered first for inclusion in the Detail column: <code>country_name</code> , <code>DialPlanName</code> , <code>name</code> , <code>ip</code> , <code>host</code> , <code>address</code> , <code>description</code> , <code>username</code> , <code>type</code> , <code>entity_id</code> , <code>userid</code> , <code>pattern</code> , <code>RoleCurrent</code> . Otherwise, the Detail column will be empty.

Note that the contents of the Detail column of transaction lists are not localized.

24.4.6. Filtering Transactions

Choose **Administration Menu > Transaction** to open the list of parent transactions. When a parent transaction is selected and opened from the list view, its details and sub-transactions are shown.

To open the **Transaction Search Filter** pop-up, use either:

1. the **Filter** button at the bottom of the list
2. one of the filter icons in a column header of the list

A transaction filter is a logical AND operation over a number of active search criteria related to column values that are entered in the **Transaction Search Filter** pop-up form:

- **Transaction ID:**
 - Equal: Default setting. The search only matches on the entered transaction or sub-transaction ID value.
 - If a value is entered, all other criteria are disabled.
 - If no value is entered, any transaction ID is matched according the other criteria.
 - Range: Start and End ID input boxes are available to specify the search ID range.
- **Include Sub-transactions:**
 - Criteria in the search filter also apply to sub-transactions. Only one level of sub-transactions are filtered, in other words, if sub-sub-transactions are for example present, these are not included.
 - The search result list view shows both parent and sub-transactions.
 - By default, sub-transactions of a parent are listed *above* the parent in the search result list view, latest date at the top.
- **Select to exclude system transactions in results:**
 - Transaction filter result list rows where the **Username** column value is `system` are *excluded*. By default, these are included in the filter result list.
- **Status:**
 - A drop-down is available to select the transaction status
- **Date Range:** a drop-down is available so that the last day, week or month can be selected quickly.

Note that if a date range: Last Day, Last Week or Last Month is selected, the subsequent re-opening of this filter will show it as a *Custom* date range, since the range is then less than the selected interval.

All and Custom date options will enable **Start Date** and **End Date** controls.
- **Start Date** and **End Date** and **Time:** specify a transaction date and time range in the format of the system locale. For example, for language code `en-us`, the typed format is `mm/dd/yyyy`. The number format “9” instead of “09” is also valid.

Date picker widgets and time drop-downs can be used to specify the range, but values can also be typed in. While time drop-down values only show 15 minute intervals, any valid minute value can be typed in. The widget values also follow the system locale format.

 - If a Username, Detail or Message filter is added, a warning about possible slow filtering will show if the transaction date range is more than 7 days.
 - By default, all transaction dates are searched, but if used, *both* Start Date and End Date values are required.

- **Action:** a drop-down to select a value from the **Action** column.
 - The drop-down options are filtered while text is entered.
 - If text is entered that does not match any action exactly, all actions containing the text (case-insensitive), will be listed.
 - If the transaction date range is more than 7 days, a warning about possible slow filtering will show.
- **Username:** filter on the **Username** column text.
 - The column should contain the entered text, case-insensitive.
 - If the transaction date range is more than 7 days, a warning about possible slow filtering will show.
- **Detail:** filter on the **Detail** column text.
 - The column should contain the entered text, case-insensitive.
 - If the transaction date range is more than 7 days, a warning about possible slow filtering will show.
- **Message:** filter on the transaction message
 - The message contains the entered text, case-insensitive
 - If the transaction date range is more than 7 days, a warning about possible slow filtering will show.
 - For *failed transactions*, hover over the **Status** column to see the message or inspect it in the detail view.
 - Some *successful transactions* also show messages when viewing its details, for example data import and bulk load.

Since transaction filters can take a long time, a filter timeout is added to limit the filter duration to 2 minutes.

Active transaction, sub-transaction and transaction log filters are displayed - according to the Admin Portal in use, either:

- In text above the column headers

or

- at the bottom of the list view, as an **X** button next to the active Filter funnel icon. Select this **X** button to cancel a running filter. If the filter is a modification of a previous successful filter, the running filter will be reverted to the successful filter.
- in the columns headers that have been filtered, as highlighted funnel icons on the right hand side of the column header.

24.4.7. Filtering Sub-Transactions and Logs

Some transactions have sub-transactions as well as a log list on the transaction detail view. The filtering of sub-transactions and logs works like the list view filter, in other words, a range of matching operators are available.

If a sub-transaction has further sub-transactions, click the Link in its Transaction column to carry out any filtering on nested sub-transactions. To navigate up the sub-transaction hierarchy, click the parent Link.

The sub-transactions and log columns to filter by, are:

- Sub-Transactions:
 - Action
 - Status

- Detail
- Logs:
 - Severity
 - Message
 - Duration (some logs - only equals and not equals)

For details on matching operators when filtering sub-transactions and logs, refer to “Filtering Lists”.

24.4.8. Transaction Behavior

The VOSS-4-UC transaction engine ensures that configuration changes are made efficiently and reliably.

In the event of a transaction failure or error, VOSS-4-UC allows for transactions to be rolled back to a state preceding the failed transaction.

For example, where a workflow step fails, all successful steps prior to a failed step are rolled back.

Transactions are hierarchical and have parent-child relationships with other transactions. Sub-transactions are always executed sequentially and synchronously, in other words the child transactions of a workflow parent transaction are executed one after another.

Transaction behavior is different for the following actions in the system:

- API

The API supports executing transactions in both synchronous and asynchronous modes. When executed in synchronous mode the API responds only once the transaction has completed. When executed asynchronously, the API responds immediately with a transaction ID so that the progress and status of the transaction can be polled.

- Bulk Loaders

With bulk loading, the load of each row on a sheet is a separate transaction. These transactions are run in series. There is no rollback of rows that have loaded successfully prior to, or subsequent to, a failed transaction (a failed row on a sheet). Multiple bulk load sheets can be loaded in parallel.

- Data Import

A single transaction is created for each record in the import file. If a single transaction fails, the import continues and does not roll back the preceding successful transactions.

- Data Sync

A single parent transaction is created for a data sync action. The subsequent device API requests are not handled as sub transactions but are executed in-line.

- Events

Events can be triggered as part of data sync operations or as triggers on operations performed on certain model types. The provisioning workflow executed when the event triggers is executed as a new parent transaction. Transaction failures with the workflow executed after an event do not affect the original transaction that triggered the event.

All transactions are placed on a queue before they are actioned. If the system queue service is restarted while a long-running transaction such as data sync or bulk load is running, all running transactions that are a part of this transaction will be marked as failed and finalized.

Parent transactions can run concurrently, but their subtransactions run serially. There is priority in parent transactions so that user input such as adding on a Admin Portal form will be prioritized over a running import or bulk load process.

24.4.9. Transaction Priority

Transactions can currently have two levels of priority: normal and low.

Normal priority transactions will be processed ahead of any low priority task in the queue.

Low priority transactions have a time limit associated with them. This means that if a low priority transaction is in the queue for more than a day, it will be processed as a normal priority transaction.

The following transactions have a low priority:

- Data sync
- Bulk load
- Data import (JSON import)

Any sub-transaction of these transactions also have a low priority.

24.4.10. Transaction Log Example

This section aims to examine the transactions, sub-transactions and logs that are displayed when an example wizard is executed.

The aim of the wizard is to provide the user with a series of steps to allow input and choices. When the wizard is executed, a Workflow is run and this is displayed as an Action on the Transaction list.

The workflow executes tasks to:

- Add a hierarchy.
- Add devices at the created hierarchy if selected.
- Add a user to the system and if selected, add a user to devices and also LDAP and SSO users if selected.

After the wizard is run, the sub-transactions show the actions of the workflow. In the example, only the Unified CM is selected. The first action in the wizard is to execute a workflow, that results in three sub-transactions. The first sub-transaction is itself a workflow that carries out three actions:









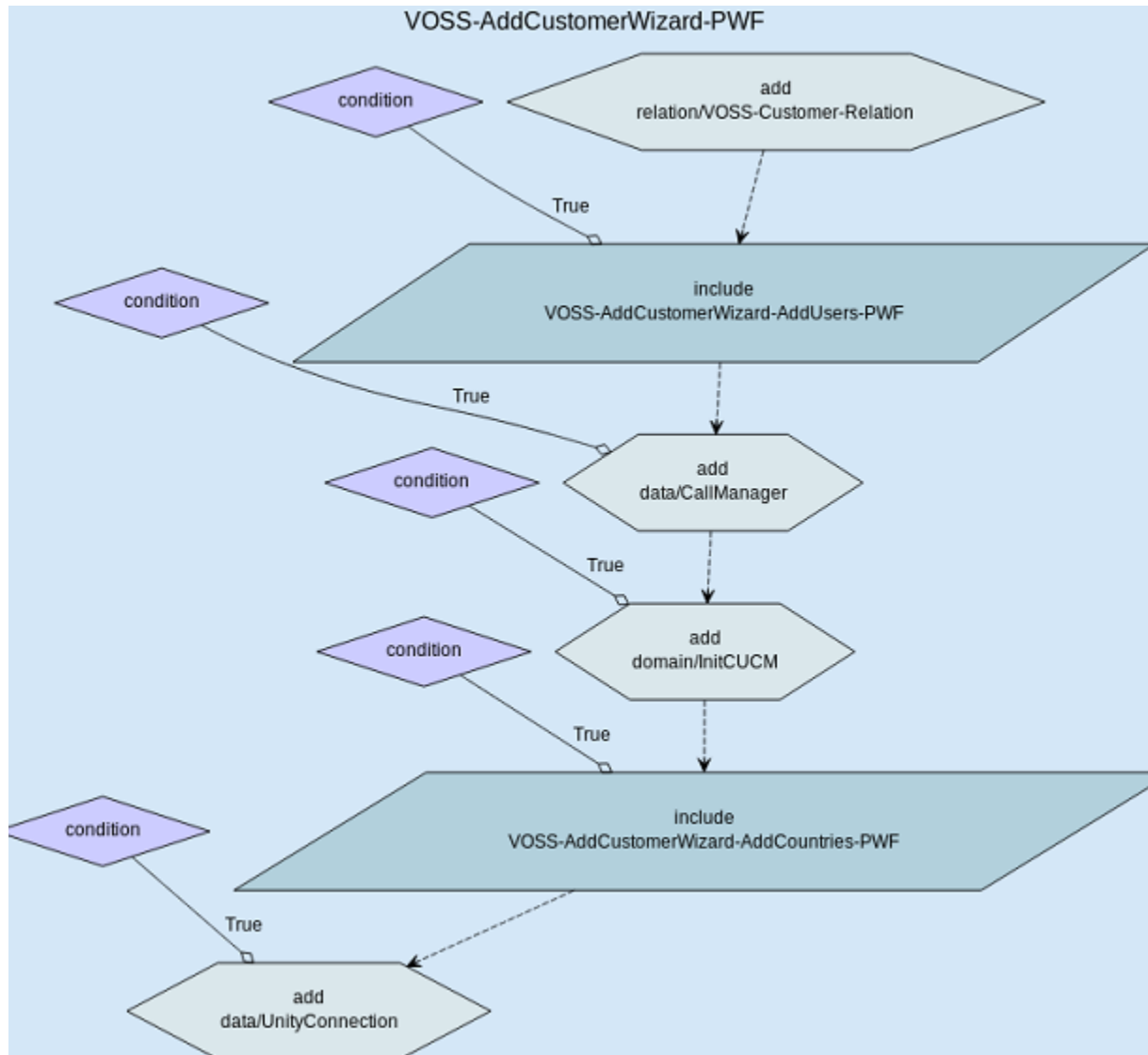



















Execute : VOSS-AddCustomerWizard-PWF

1. Create Voss-Customer-Relation Execute : VOSS-Relation-Add-Customer-PWF
 - a. Create Hierarchy Node
 - b. Create Base Customer Dom
 - c. Create Voss Cust Dp
2. Create User
3. Create Call Manager

The transaction log shows all the steps of all the workflows that are executed. The first log entry of the wizard is at the bottom of the log list. The first step of each workflow is marked as *Step 0*.

The figures below show the example wizard flow and the corresponding logs.



Transaction		
Mar 27, 2014 15:26:1 SAST	info	Step 5 - Start include VOSS-AddCustomerWizard-AddCo 
Mar 27, 2014 15:26:1 SAST	info	Step 4 - End 
Mar 27, 2014 15:26:1 SAST	info	Step 4 - Condition unmet, skipping step. 
Mar 27, 2014 15:26:1 SAST	info	Step 4 - Start add domain/InitCUCM 
Mar 27, 2014 15:26:1 SAST	info	Step 3 - End 
Mar 27, 2014 15:26:1 SAST	info	Step 3 - Template (AddCustomerWizard_CUCM_CFT) aft 
Mar 27, 2014 15:26:1 SAST	info	Step 3 - Template (AddCustomerWizard_CUCM_CFT) be 
Mar 27, 2014 15:26:1 SAST	info	Step 3 - Template after merging AddCustomerWizard_Cl 
Mar 27, 2014 15:26:1 SAST	info	Step 3 - Start add data/CallManager 
Mar 27, 2014 15:26:1 SAST	info	Step 1 - End 
Mar 27, 2014 15:26:1 SAST	info	Step 1 - End 
Mar 27, 2014 15:26:1 SAST	info	Step 1 - Template (AddCustomerWizard_User_CFT) after 
Mar 27, 2014 15:26:1 SAST	info	Step 1 - Template (AddCustomerWizard_User_CFT) befo 
Mar 27, 2014 15:26:1 SAST	info	Step 1 - Template after merging AddCustomerWizard_U: 
Mar 27, 2014 15:26:1 SAST	info	Step 1 - Start add data/User 
Mar 27, 2014 15:26:1 SAST	info	Step 0 - Executing workflow (dynamic_workflow) with thi 
Mar 27, 2014 15:26:1 SAST	info	Step 1 - Executing workflow for each [1] 
Mar 27, 2014 15:26:1 SAST	info	Step 1 - Start add data/User 
Mar 27, 2014 15:26:1 SAST	info	Step 0 - Executing workflow (VOSS-AddCustomerWizard: 
Mar 27, 2014 15:26:1 SAST	info	Step 2 - Including_workflow, name: VOSS-AddCustomer) 
Mar 27, 2014 15:26:1 SAST	info	Step 2 - Start include VOSS-AddCustomerWizard-AddUs 
Mar 27, 2014 15:26:1 SAST	info	Step 1 - End 
Mar 27, 2014 15:26:1 SAST	info	Step 1 - Template (AddCustomerWizard_VOSS-Custome) 
Mar 27, 2014 15:26:1 SAST	info	Step 1 - Template (AddCustomerWizard_VOSS-Custome) 
Mar 27, 2014 15:26:1 SAST	info	Step 1 - Template after merging AddCustomerWizard_W 
Mar 27, 2014 15:25:56 SAST	info	Step 1 - Start add relation/VOSS-Customer-Relation 
Mar 27, 2014 15:25:56 SAST	info	Step 0 - Executing workflow (VOSS-AddCustomerWizard 
Mar 27, 2014 15:25:56 SAST	info	Step 0 - Executing workflow (VOSS-AddCustomerWizard 



Direction

24.4.11. Device Data Sync Errors in Transactions

The DataSync from a device has two steps:

1. A list request for all the resources of a specific type is made, for example for a User or Phone.
2. Requests for detailed information of each resource of the specific type.

The tables below show errors raised by devices and how these are handled or written to the transaction log by VOSS-4-UC. In the case of failed transactions, the tables point to possible causes of some errors.

Note:

- A number of CUCM device model errors are non-critical and will not fail data sync transactions.
- CUCM AXL handled by VOSS-4-UC (DataSync transaction final status is not failed)

Model	Operation	Device Error Message Match	VOSS-4-UC DataSync Action and/or error log
LocalRouteGroup	GET	No Search Criteria Defined	Ignored known error
LdapDirectory	GET	Item not valid: The specified LdapDirectory was not found	Ignored known error
UniversalDeviceTemplate	GET	Item not valid: The specified UniversalDeviceTemplate was not found	Ignored known error
LicensedUser	GET	Item not valid: The specified LicensedUser was not found';The endpoint reference (EPR) for the Operation not found is No License found for the specified user: Could not open database table	Ignored known error
LdapSyncCustomField	GET	Invalid LdapConfigurationName	Ignored known error
EndpointReleaseKey	GET	Column (name) not found in any table in the query (or SLV is undefined)';The endpoint reference (EPR) for the Operation not found is	Ignored known error
DirNumberAliasLookupan dSync	GET	Item not valid: The specified DirNumberAliasLookupandSync was not found	Ignored known error
DeviceSerialNumber	GET	endpoint reference (EPR) for the Operation not found is	Ignored known error
LicenseCapabilities	GET	The endpoint reference (EPR) for the Operation not found is	Ignored known error
PhoneTypeDisplayInstance	GET	Wrong value for Protocol. Please enter a valid value.	Not all Phone Types have Vendor Config Rules. Ignored.

- HCMF handled by VOSS-4-UC (DataSync transaction final status is not failed)

Model	Operation	Device Error Message Match	VOSS-4-UC DataSync Action and/or error log
TransportModeSettings	GET	API Call Error [404]	Ignored known error
SmartAccountsAccessCredentials	GET	API Call Error [404]	Ignored known error

- CUCM Device errors not handled by VOSS-4-UC (DataSync transaction final status is failed)

Model	Operation	Model Error	Possible Cause
(All model types)	GET	Resource not found	A workflow in VOSS-4-UC deleted an item between the DataSync LIST operation and the GET operation
(All model types)	GET	AXL Error [-1]	This is a non-specific error raised by CUCM. Follow up with the CUCM team.

- CUC Device errors not handled by VOSS-4-UC (DataSync transaction final status is failed)

Model	Operation	Model Error	Possible Cause
(All model types)	GET	Resource not found	A workflow in VOSS-4-UC deleted an item between the DataSync LIST operation and the GET operation
ImportUser	GET	Resource not found	<ol style="list-style-type: none"> 1. A sync between CUC and LDAP is running at the same time as the VOSS-4-UC sync to CUC. If the User is disabled or deleted on LDAP, then the User would be removed as an Import User on CUC. 2. A workflow on VOSS-4-UC promoted a user from Import User to User by creating a Voicemail Box for that User, which also causes the user to be removed as Import User and created as a full User.

24.4.12. Export a Transaction

Administrators can export upper level parent transactions. This will include their child sub-transactions as well as the associated transaction log entries in JSON format.

The exported files may also be requested by VOSS support operators for troubleshooting purposes.

1. From the **Transaction** list view (default menu **Administration Tools > Transaction**), select a parent transaction.
2. From the transaction details view, choose **Export** from the button bar. A .zip archive file is downloaded by the browser.

Transaction Export Files and Format

The .zip archive filename format:

export-tx-<Transaction ID>_<YYYY>-<MM>-<DD>T<HH_MM_SS>.json.zip

Example: `export-tx-20705_2019-01-22T06_18_15.json.zip` for parent transaction ID 20705.

The .zip archive contains two files in JSON format:

- The Transaction Detail file - containing transaction (parent and sub-transaction) details as on the Admin Portal - upper level and **Sub Transactions** table entries in JSON format:

export-tx-<Transaction ID>_<YYYY>-<MM>-<DD>T<HH>:<MM>:<SS>.json

- The Transaction Log file - containing entries as on the table of **Log** entries of a transaction on the Admin Portal (up to 1000 entries) in JSON format:

export-tx-logs-<Transaction ID>_<YYYY>-<MM>-<DD>T<HH>:<MM>:<SS>.json

Transaction Detail File Format

The example snippet below shows transaction details data of the the upper level parent.

- Upper level parent entries are identified by the same `pkid` and `top_level` values, with `"parent_pkid": null`.
- Child and descendant entries show different `pkid` and `parent_pkid` values. The tree of parent and child entries can be determined by inspecting these values.

```
"processor_host_name": "VOSS-voss-queue",
"pkid": "c0a03e99-0c93-4d85-8736-f05b54f8fe55",
"hierarchy": "5c46a8efce894e001453b2a8",
"submitted_time": "2019-01-22T06:18:15.804000Z",
"started_time": "2019-01-22T06:18:15.839000Z",
"detail": "[ 9\\ /9 ] succeeded from [ 1 ] sheet in H2-5-VOSS4...",
"top_level": "c0a03e99-0c93-4d85-8736-f05b54f8fe55",
"priority": "Normal",
"duration": 3.187191,
"submitter_host_name": "VOSS",
"txn_seq_id": "20705",
"parent_pkid": null,
"action": "Execute Bulk Load",
"message": null,
"completed_time": "2019-01-22T06:18:19.026000Z",
"operation": "execute"
```

Transaction Log File Format

The snippet below has been formatted for readability. The `transaction_id` in the two entries shown will correspond with `pkid` entries in the Transaction Detail file, so that the Log entries can be associated with the transactions and sub-transactions.

```
{
  "severity": "info",
  "format": "text",
  "log_id": "5c46b5a7ce894e0014569a0b",
  "time": "2019-01-22T06:18:15.871000",
```

(continues on next page)

(continued from previous page)

```

"message": "H2-5-VOSS4UC-HCS-Customer_Data_ClassOfService...
"transaction_id": "c0a03e99-0c93-4d85-8736-f05b54f8fe55"
},
{
  "severity": "info",
  "format": "text",
  "log_id": "5c46b5abce894e0014569ab3",
  "time": "2019-01-22T06:18:19.012000",
  "message": "Summary for sheet: Sheet1, No errors",
  "transaction_id": "d7aa7333-f692-40b4-a637-80cf456c1f70"
},

```

24.5. Northbound Notifications

24.5.1. Northbound Notification

The VOSS-4-UC Northbound Notification (NBN) provides a mechanism to notify an Operations Support System (OSS) or Business Support System (BSS) when user data in VOSS-4-UC is created, updated, or deleted. The Northbound Notifications can be customized to specify which events trigger notification and the destination of notifications.

The supported model types are:

data/User Essential user information. Changes occur either from LDAP sync or manually in VOSS-4-UC.

relation/Subscriber Subscriber information, such as assigned devices and services. Only changes made in VOSS-4-UC via Subscriber Management generate notifications. Changes to subscribers made in VOSS-4-UC do not generate notifications.

All NBN events are post-execution so the notification is sent immediately after the data is changed in VOSS-4-UC.

Note: Failing changes to user data result in a pair of notifications, one for the attempted change and an opposite one for the rollback of the change. For example, a failing user add generates a create notification and a delete notification.

To suspend notifications for a given model type and operation, mark the event as 'inactive' and notifications will neither be sent nor stored while the event is inactive. Once the event is marked as 'active', subsequent notifications will be sent.

24.5.2. Notification Format

The Northbound Notifications are sent to a destination as HTTP or HTTPS POST requests. The message body is a JSON map that contains the notification data. The JSON map is in this format:

Key	Datatype	Operation
model_type	String	All
operation	String	All
pkid	String	All
hierarchy	String	All
new_data	Map	Create/Update
previous_data	Map	Update/Delete

The keys in the new_data and old_data maps are the attribute names for the given model type.

Example

See this example of a notification's message body triggered by updating a user:

```
{
  'model_type': 'data/User',
  'operation': 'update',
  'pkid': '5445310900698a11d83164e3',
  'hierarchy': '543c57ea00698a11d8305815',
  'new_data': {
    'username': 'jdoe',
    'email': 'jdoe@provider.com',
    'department': 'Finance'
  },
  'previous_data': {
    'username': 'jdoe',
    'email': 'jdoe@provider.com',
    'department': 'Admin'
  }
}
```

24.5.3. NBN Transaction Processing

Once an NBN event is triggered, it is handled in a new transaction independent of the original transaction that triggered the event. These transactions can also be queried through the transaction log. The result of the NBN transaction will be successful if a positive HTTP or HTTPS response code is received from the OSS/BSS. If no response is received (timeout) or a negative response code is received, the transaction will show as failed.

24.5.4. Northbound Notification Workflow

Perform the following procedures to configure northbound notification.

Perform these steps:

1. Configure Northbound Notification Destination to specify the destination for northbound notifications.
2. Configure Northbound Notification Event to specify an event to trigger the northbound notification.

3. Configure Northbound Notification Event Attributes to specify the list of attributes to be received in a notification for a specific event.

Note:

Steps 2 and 3 can be performed in either order, but after the list attributes are defined in Step 3 you will need to edit the event (Step 2) to add or update the Attribute Selector field.

24.5.5. Configure Northbound Notification Destination

Use this procedure to set the destination for Northbound Notifications of VOSS-4-UC events. Only one NBN destination can be configured.

Note: You cannot delete a destination until it is removed or disassociated from all events.

Perform these steps:

1. Log in as provider administrator.
2. Choose **Administration Tools > Northbound Notifications > Destination**.
3. Click **Add**.
4. Provide the following information for the destination:

Field	Description
Hostname/IP Address	Hostname or IP address of the OSS/BSS http server. This field is mandatory.
Port	The destination port. This field is mandatory.
Username	If the OSS/BSS http server has authentication enabled, specify the username to use.
Password	The password for the above username.
Secure	Use HTTPS send method for secure transport of the notification. Default = Selected. Clear the check box to use HTTP instead.

5. Click **Save**.

24.5.6. Configure Northbound Notification Event Attributes

You can use attribute selectors to define the attributes to be received in a notification for a particular event. Notifications contain only the specified fields and are not sent if none of the fields are chosen.

Note: You cannot delete an attribute selector until it is removed or disassociated from all events.

Important: It is possible to create an attribute selector through the API with 'invalid' attributes as there is no API validation on the list of attributes. We recommend using the Admin Portal or API to retrieve the list of attributes prior to creating an attribute list through the API. Refer to the API Reference Guide. If an invalid

attribute is added to an attribute filter, the transaction will succeed but notifications will not contain the chosen field.

Perform these steps:

1. Log in as provider administrator.
 2. Choose **Administration Tools > Northbound Notifications > Attributes**.
 3. Click **Add**.
 4. Enter a unique name.
 5. Choose a model type: either data/NormalizedUser or relation/Subscriber.
 6. Highlight one or more attributes and perform the following:
 - Click **Select** to add an attribute to the list of chosen attributes. You can also select multiple attributes at a time by highlighting them and clicking **Select**. The attributes move from the **Available** box to the **Selected** box.
 - Click **Remove** to remove an attribute from the list of chosen attributes. You can also remove multiple attributes at a time by highlighting them and clicking **Remove**. The attributes move from the **Selected** box to the **Available** box.
- Example: For the data/User model, you could select Username, First Name, Last Name, Phone Number, and Mail. Notifications are then sent when an event occurs that includes one or more of these attributes.
7. Click **Save**.

Apply the event attributes to an event by adding or updating the event and choosing the desired attribute selector.

24.5.7. Configure Northbound Notification Event

You must set the Northbound Notification Destination before you can configure events.

Use this procedure to specify an event to trigger Northbound Notifications.

1. Log in as provider administrator.
2. Choose **Administration Tools > Northbound Notifications > Events**.
3. Click **Add**.
4. Provide the following information for the triggering event:

Field	Description
Name	Event name. Must be unique. This field is mandatory.
Description	A description of the event
Active	Select to turn on notification.
Model Type	Choose either data/User or relation/Subscriber as the model type of the data that triggers the event. This field is mandatory.
Operation	Choose from the operations applicable to the selected model type. This field is mandatory.
Attribute Selector	Set an attribute selector to restrict (filter) the list of attributes sent in notifications for this event. This field is optional. To remove an existing attribute selector, backspace and delete it from the Attribute Selector field. If you do not specify an attribute selector, all possible attributes are sent in notifications for this event.
Destination	The provider's NBN destination. This field is read-only.

5. Click **Save**.

24.6. Schedules

24.6.1. Scheduling

Single or Multiple actions can be executed on one or more resources. The actions can be scheduled to take place at a specified time or to repeat.

Currently, the action is to *execute*.

The resources that can be executed are:

- **Data Sync**
- **Script**
- **Provisioning Workflows**
- A schedule can be created during the Bulk Load process. Bulk loaded files that are not set to Execute Immediately can be scheduled by Execution Date, -Time and -Timezone. A scheduled bulk load is shown on the Schedule as a **Single Execution** schedule type and with the Resource Type as **data/BulkLoad**.

Care should be taken when transactions are scheduled. For example, data synchronization should be scheduled outside of peak times. The size and scope of the transactions that run determine the length of the time that they need to run. This therefore impacts on the start time. The number of clusters on the system and their size need to be considered as part of a data sync approach.

24.6.2. Create or Update a Schedule

1. Choose the hierarchy at which the schedule is to be created.
2. Open the **Scheduling** form (default menu **Administration Tools > Scheduling** to view existing schedules (if configured).
3. To Create, click **Add** open the **Scheduling** input form to create a new schedule. To Update, select a schedule to modify.
4. On the **Base/Details** tab, complete the following:
 - a. Enter a mandatory **Schedule Name**.
 - b. Enter the **Owner** (the user who created the schedule).
 - c. From the mandatory **Schedule Type** drop-down list, choose either the **Multi Execution** or **Single Execution** option. This enables the respective **Multiple Executions** or **Single Execution** tab on the input form.
 - d. Select or clear the **Active** check box to enable or disable the entire schedule.
5. Click **+** next to **Scheduled resources** to specify actions to execute on resources (if required). More than one action on more than one resource type can be scheduled, with specification of a resource attribute.
6. Select the **Resource Type**. The resources that can be executed is `data/DataSync`.
7. For a selected Resource Type, select a unique identifier as **Resource Attribute**, often the name of the Resource Type, typically `name`.
8. For the **Resource**, select the value of the Resource Attribute. For example, if the attribute is `name`, then the name of the resource.
9. The **Perform Action** check box is used to enable or disable a specific scheduled resource action.
10. On either the **Multiple Executions** or **Single Execution** tab, enter the scheduling time information according to the selected schedule type.
 - Date format: `YYYY-MM-DD` in Local time - an **Execution Timezone** is selected
 - Time format: `HH:MM:SS` in Local time - an **Execution Timezone** is selected
 - a. For Multiple Executions, select or clear the following check boxes for execution options on the **Multiple Executions** tab:
 - i. **Use Specific Executions** - Allows one or more specific schedule times: an **Execution Date**, **Execution Time** and **Execution Timezone** is added for each specific schedule.
 - ii. **Use Calendar Executions** - Allows one or more calendar times (**Calendar Hour** and **Calendar Minute**) and dates (**Calendar Month** and **Calendar Day**). If no time is entered, the current time is used.
 - iii. **Use Timed Executions** - Allows one or more specified number of repetitions (**Number of Repeats**) at intervals (**Repeat after (x) Days**, **Repeat after (x) Hours**, **Repeat after (x) Minutes**) from a specified start time (**First Execution Date**, **First Execution Time**, **First Execution Timezone**).

If more than one of these options is selected, the first scheduled time will take priority.
 - b. For Single Executions, provide the **Execution Date**, **Execution Time** and **Execution Timezone** on the **Single Execution** tab.
11. Click **Save** to create the schedule.

The scheduled task is displayed on the Schedule list view.

24.7. System Settings

24.7.1. Manage System Settings

Administrators at provider level as well as `hcsadmin` administrators have access to a **System Settings** menu under **Administration Tools**.

Transaction Log Level

Provider level and `hcsadmin` administrators can modify the Transaction Log Level - the level of verbosity of transaction logs.

The setting is available as a global setting to high level administrators who have access to the `data/Settings` model. When an administrator first opens **System Settings**, the displayed value for the **Transaction Log Level** is the default in the global setting.

For a description of the available log levels, see: [Transaction Log Levels](#)

The settings are:

- Disabled
- Error
- Warning
- Info
- Verbose
- Debug

The purpose of the setting is so that the log level can be changed according to need, for example to `Verbose` so that more details are available for immediate troubleshooting and customization work.

Note: A **Notes** section and warning is shown if the level is set to `Verbose` or `Debug`, reminding administrators that the retention period of such logs is shorter due to their increased size, which consequently reduces the date range of available logs for troubleshooting.

A typical use of this setting would be for troubleshooting: when a problem is encountered on a system and detailed logs need to be obtained. The steps could then be:

1. Toggle the log level to `Verbose`.
2. Reproduce the issue causing the problem.
3. Export the logs and forward them to VOSS support.
4. Toggle the log level back to `Info`.

25. Single Sign On (SSO)

25.1. Single Sign On (SSO) Overview

VOSS-4-UC supports Single Sign-on (SSO) through the SAML v2 standard for SSO. The system acts as a service provider in the SAML authentication architecture and supports service provider initiated (SP-initiated) authentication of users against a SAMLv2 Identity Provider (IdP).

Authentication settings on an IdP server include **Authentication Scope** and **User sync Type** - see: *Configure Single Sign-On for VOSS-4-UC*.

Users accessing VOSS-4-UC using SSO authentication are required to access the system using an URL which is specific to the IdP setup in the VOSS-4-UC system. This ensures the SAML interaction is with the correct IdP, since VOSS-4-UC supports multiple IdPs to be set up in the system.

When accessing the URL, the user will be presented with the login challenge via the Identity Provider (outside of VOSS) if they do not already have a session active on the IdP. Once authenticated with the IdP, the assertion from the IdP is sent to VOSS-4-UC from the IdP and the user will be given access and presented with the appropriate interface in VOSS-4-UC (admin or self-service). If users already have an authentication session with the IdP, they do not see the IdP login page and will be directed straight to VOSS-4-UC.

Note:

- Credential policy features such as password rules, session length, etc. are all managed by the IdP outside of VOSS-4-UC.
- Single Sign-on support is for authentication only and does not apply the user's permissions within the VOSS-4-UC.
- No logout is supported when using SSO (single sign-out). VOSS-4-UC will not initiate the termination of

25.2. SSO Certificate Management

Use this procedure to create a self-signed or third-party-signed system certificate to use when setting up Single Sign-On (SSO) on the web proxy node on VOSS-4-UC.

Note:

- Web server certificate management is carried out on the VOSS-4-UC command line. Refer to the CLI documentation for details.

- During customer onboarding, SSO certificate creation is customer specific.

Procedure

1. Log in as system administrator.
2. Choose **Single Sign On > Certificate Management**.
3. Click **Add**.
4. On the **Base** tab, enter a **Name** and **Description** for the certificate.
 - For a self-signed certificate, leave the **Generate Certificate Signing Request** check box clear.
 - For a third-party-signed certificate, select the **Generate Certificate Signing Request** check box.
5. For a self-signed certificate, control when the certificate is valid by changing the Valid From and Valid To fields. These are measured in seconds and default to 0 (now) and 315360000 (10 years), respectively.
6. (Optional) Change the **Key Length** from the default of 1024.
7. Click the **Certificate Information** tab, and complete all mandatory fields (see **Certificate Management** fields).
8. Click **Save**.
9. If you created a self-signed certificate you are done. If you requested a third-party-signed certificate, continue to the next step.
10. Click the certificate you just created.
11. Choose **Action > Export Certificate Request**.
12. Follow your organization's procedures to obtain the third-party signature for the certificate.
13. Click the certificate.
14. Choose **Action > Upload Signed Certificate**.
15. Browse to the signed certificate and click **OK**.

25.2.1. Certificate Management Fields

Field	Description
Common Name *	Enter the FQDN for your server.
Country Code *	A two-digit country code
State *	An appropriate country subdivision
City *	Your city
Organization *	Your organization
Organization Unit *	Your organization subunit

25.3. Configure Single Sign-On for VOSS-4-UC

This procedure configures self-service Single Sign-On (SSO) for VOSS-4-UC.

The configuration applies to customers and customer administrators associated with the identify provider (IdP).

Note: Administrators are configured for SSO use via the **Users** form (default menu **User Management > Users**).

Prerequisites

- Create a self-signed or third-party-signed system certificate. For more information, see [SSO Certificate Management](#).
- The VOSS-4-UC server and the IdP server must be configured so that their clocks are synchronized.

25.3.1. SSO Service Provider Configuration

1. Log in to VOSS-4-UC as system administrator.
2. Choose **Single Sign On > SSO SP Settings**.

Note: This screen is only available to you if you've logged in as a higher-level administrator.

3. Click **Add**.

Note: Configure only one instance of SSO SP Settings.

4. On the **Base** tab:
 - (Mandatory). From the **System Certificate** drop-down, choose the System Certificate to use. See [SSO Certificate Management](#).
 - To allow the SSO SP Setting to expire, enter a number of hours in the **Validity (Hours)** field.

Note:

- Specifying an unsigned third-party-signed certificate results in an error.
 - To renew an expired certificate, see [Renew Single Sign-On Certificate for VOSS-4-UC](#).
-

5. On the **SAML SP Settings** tab:
 - Enter the mandatory **FQDN of the Server**.
 - Select the **Sign Authn Requests** and **Want Assertions Signed** check boxes as required by your security environment.

Note:

- Only select **Want Reponse Signed** if you're sure that all IdPs sign responses.

- If a secure connection is required with the secure attribute set on the cookies, the URL values for bindings of End Points must be specified with `https`.

6. Click **Save**.
7. To view the location of the VOSS-4-UC SP metadata that you will upload to the IdP:
 - Choose **Single Sign On > SSO SP Metadata**.
 - Point your browser to the URL shown here, and then save a copy of the SP metadata.
8. Upload the SP metadata to the IdP.

Refer to your IdP documentation for details on adding VOSS-4-UC as a service provider.

Note: The IdP must release the UID and map it to an appropriate attribute. For example, an IdP that authenticates with Active Directory can map the uid SAML attribute to sAMAccountName in the Active Directory server.

9. Download the IdP metadata from the IdP server.

Refer to your IDP documentation for details on downloading IDP metadata.

Note: If an expired SSO certificate is being renewed and the IdP metadata has *not* changed, the download, configure and upload of the IdP metadata is not required.

25.3.2. Integrating with an SSO Identity Provider

1. Log in as provider, reseller, or customer administrator (depending on your IdP configuration level).
2. Choose **Administration Tools > File Management** and upload the IdP metadata.
3. Choose **Single Sign On > SSO Identity Provider**.
4. Click **Add** to add the SSO Identity Provider configuration.

Note: Only one instance of an SSO Identity Provider can be configured for a hierarchy node.

5. On the **SSO Identity Provider** screen, complete at least the mandatory fields (Entity ID, Login URI, Local Metadata File, User lookup field at minimum, the mandatory **SSO Identity Provider** fields (see **SSO Identity Provider** fields):

If a customer is using a *custom domain*, the **Service Provider Domain Name** is filled in at the hierarchy level and the login and metadata URLs used will be tied to the IdP as follows:

```
SSO Login URL:      ``https://<Service Provider Domain Name>/sso/<Login URI>/
↪login``
Admin Portal:      ``https://<Service Provider Domain Name>/admin/sso/<Login_
↪URI>/login``
Business Admin Portal: ``https://<Service Provider Domain Name>/business-admin/
↪sso/<Login URI>/login``
```

The metadata is obtained from: `https://<Service Provider Domain Name>/sso/<Login URI>/metadata`

If the Service Provider Domain Name is specified, the metadata XML file from VOSS-4UC then contains `Service.Provider.Domain.Name` in the assertion consumer service URL as shown in the example below:

```
<md:AssertionConsumerService
  Binding="urn:oasis:names:tc:SAML:2.0:bindings:HTTP-POST"
  Location="https://Service.Provider.Domain.Name/sso/acs/"
  index="1"/>
```

This metadata needs to be uploaded to the IdP (not the generic metadata obtained from SSO Service Provider Configuration).

Important: If you have previously uploaded metadata to the IDP and you subsequently complete this **Service Provider Domain Name** field, you need to remove the previous record from the IDP and re-upload the metadata so that it contains this field.

6. Click **Save** to save the SSO Identity Provider Configuration and enable SSO if selected.
7. Choose **User Management > Users** and filter on **Auth Method** equals `SSO` to display enabled SSO users.

When the **Service Provider Domain Name** is not specified for a given IDP, these URLs are used for SSO login:

```
SSO Login URL:      ``https://<FQDN of the Service Provider>/sso/<login_URI>/
↳login``
Admin Portal:      ``https://<FQDN of the Service Provider>/admin/sso/<Login URI>/
↳login``
Business Admin Portal: ``https://<FQDN of the Service Provider>/business-admin/sso/
↳<Login URI>/login``
```

See **SAML SP Settings FQDN** in *SSO Service Provider Configuration*.

The IdP redirects to this FQDN on login.

Note: While an IdP may exist at more than one hierarchy in VOSS-4-UC, a user will only be permitted to log in if the user exists at or below the hierarchy of a single IdP.

25.3.3. SSO Identity Provider: Field Reference

Field	Description
Entity Id	Mandatory. Entity ID of the IDP. This field must exactly match the entity ID in the IdP metadata file.
Login URI	Mandatory. Login URI for the IDP. This is the URI that will be embedded in SSO Login URL. It can contain only alphanumeric characters and forward slashes.
Service Provider Domain Name	The FQDN that will be embedded in the SP metadata for this IdP for URLs that refer back to the Service Provider.
Local Metadata File	Mandatory. Choose the IdP metadata file. This field must be unique across the system.
SSO Enabled	Select the check box to enable SSO for users synced in or created at the current hierarchy level. Clear this check box to disable SSO for the users associated with the defined IDP.
Note	Reminder to upload the IdP metadata file
SSO Login URL	Read-only field displays the SSO Login URL to use.
Business Admin Portal Login URL	Read-only. Displays the Business Admin Portal SSO Login URL to use.
Admin Portal Login URL	Read-only. Displays the new Admin Portal SSO Login URL to use.
User lookup field	Mandatory. Select the field to bind the VOSS and SSO user - typically username.
Authentication Scope	Hierarchical scope this server applies to. <ul style="list-style-type: none"> • Full tree authentication (default): All nodes at and below this node in its tree can authenticate against this server. • Local authentication: Only users at this node can authenticate against this server.
User sync type	Type of users that can authenticate against this server. <ul style="list-style-type: none"> • Synced users only: Only users synced in from LDAP can authenticate against this server. • All users

For Authentication Scope, also see [User Login Options by Authentication Method and Server Authentication Scope](#).

25.4. Configure the System as a SSO Service Provider

The configuration below is available to high level administrators *above* the provider administrator from a menu called **SSO SP Settings**.

1. On the **Base** tab, enter the Entity ID is required and is used to identify VOSS-4-UC as service provider. The URL points to the metadata, for example `http://mydomain/sso/metadata/`.
2. Choose the Public key and Private key that were uploaded using the data/File model and that will be used to communicate with identity providers. Alternatively, if you want to use a system generated

certificate, select the check box and choose the required certificate from the drop-down list. These certificates were added typically using **System Configuration > Certificates** or a similar menu that creates data/certificate instances.

3. Enter the Validity period (in hours) that the metadata is valid for.
4. Enter the number of seconds of the permitted clock drift between VOSS-4-UC and the Identity Provider. The number of seconds for tolerance is customizable, and this value must be set in accordance with the deployment's security policy. By default, VOSS-4-UC will use a value of 0 for the clock drift, in other words, assume clocks are exactly in sync.
5. Enter the details of the Contact Person responsible for the metadata.
6. If required, select the **Block unencrypted assertions** check box to raise an error if SAML assertions are not encrypted. If the check box is selected, and there is no encryption in the assertion, then an error message: "Unencrypted assertions are not allowed" is shown.
7. On the **Service Provider Settings** tab, enter a friendly name that will be the ServiceName of the AttributeConsumingService in the metadata.
8. If the **Sign Authn Requests** check box is selected, outgoing messages are signed and the specified private key is used. Drop-down lists are also displayed to select the SignatureMethod (default is `rsa-sha1`) and DigestMethod (default is `sha1`) corresponding with those used by the Identity Provider.
9. If an Identity Provider has `WantAuthnRequestsSigned` set in its metadata, select the check box. The check box is cleared by default.
10. The **Want Assertions Signed** check box determines if assertions should be signed. Do not clear this check box unless the integrity check of assertions is not needed in your environment.
11. The **End Points** section provides an external interface to the service provider in VOSS-4-UC. The binding determines how SAML requests and responses map onto standard messaging or communications protocols. The Assertion Consumer Service (ACS) receives assertions, while the Single Logout Service is used to log out a user when instructed by an Identity Provider.
 - a. Choose Binding and URL for the Assertion Consumer Service.
 - b. Choose the Binding and URL for the Single Logout Service.

The Saved SSO settings are published by the VOSS-4-UC service provider and are available from metadata URL, for example: `http://mydomain/sso/metadata/`. SSO service provider configuration requests to this URL automatically trigger an xml file download of the specified SSO service provider configuration.

25.5. Renew Single Sign-On Certificate for VOSS-4-UC

If a customer's Single Sign-on certificate expires, then to renew the certificate for VOSS-4-UC:

1. Follow the steps to regenerate the certificate (either self-signed or CA signed) as described in [SSO Certificate Management](#).
2. Follow the steps to regenerate and upload SP metadata to the IdP described in [Configure Single Sign-On for VOSS-4-UC](#).

Note:

If an expired SSO certificate is being renewed and the IdP metadata has *not* changed, then the download, configure and upload of the IdP metadata is not required and these steps can be ignored.

25.6. SAML Elements in Assertions

The following list provides details for designers on the correct handling of Security Assertion Markup Language (SAML) elements in assertions:

1. When using the `SubjectConfirmation` element in a SAML assertion, the `NotOnOrAfter` condition shall be used.
2. When using the `Conditions` element in a SAML assertion, both the `NotBefore` and `NotOnOrAfter` elements or the `OneTimeUse` element shall be used.
3. If a `OneTimeUse` element is used in an assertion, there shall only be one used in the `Conditions` element portion of an assertion.

The VOSS-4-UC system will inspect SAML messages and raise error messages if the elements do not follow the rules for SAML assertions specified above.

The list below shows the respective error numbers and messages as they will show in the logs, as well as example error SAML snippets:

1. NOTONORAFTER_SUBJECTCONFIRMATION_ERROR (14010)

“SubjectConfirmation is used but there is no NotOnOrAfter attribute”

```
<saml2:SubjectConfirmation Method="urn:oasis:names:tc:SAML:2.0:cm:bearer">
  <saml2:SubjectConfirmationData/>
</saml2:SubjectConfirmation>
```

2. a) CONDITION_NOT_BOTH (14012)

“NotBefore and NotOnOrAfter should be present when using either in Condition”

```
<saml2:Conditions NotOnOrAfter="2015-11-20T12:32:23.645Z">
  <saml2:AudienceRestriction>
    <saml2:Audience>http://functional.fedrampfail.plain/sso/metadata/</
↪saml2:Audience>
  </saml2:AudienceRestriction>
</saml2:Conditions>
```

2. b) CONDITION_ONETIMEUSE (14013)

“OneTimeUse element should be present when neither NotBefore nor NotOnOrAfter attributes in Condition”

```
<saml2:Conditions>
  <saml2:AudienceRestriction>
    <saml2:Audience>http://functional.fedrampfail.plain/sso/metadata/</
↪saml2:Audience>
  </saml2:AudienceRestriction>
</saml2:Conditions>
```

3. CONDITION_MULTIPLE_ONETIMEUSE (14014)

“Only one OneTimeUse element should be present in Condition”

```
<saml2:Conditions>
  <saml2:AudienceRestriction>
    <saml2:Audience>http://functional.fedrampfail.plain/sso/metadata/</
↪saml2:Audience>
```

(continues on next page)

(continued from previous page)

```
</saml2:AudienceRestriction>  
<saml2:OneTimeUse/>  
<saml2:OneTimeUse/>  
</saml2:Conditions>
```

26. Data Sync

26.1. Data Sync Overview

Data on devices may be updated within VOSS-4-UC, or directly on the device. For this reason, cached VOSS-4-UC data should be periodically synchronized with the data with the data on devices.

Example:

- When an instance of a Unified CM is added to the system, its data is imported and cached.
- When instances are added, updated, or deleted from the Unified CM, the cached data in VOSS-4-UC becomes out of sync with data on the device.
- When deleting data from Unified CM before deleting it from VOSS-4-UC, the system displays the following error: “The specified resource could not be found”

This means the resource is out of sync, and VOSS-4-UC may need to re-sync with Unified CM in order to delete it or update it.

The VOSS-4-UC data sync functionality allows you to dynamically synchronize cached VOSS-4-UC data with data on devices. The data sync instance is associated with the connection parameters of a device type in VOSS-4-UC.

Supported devices include:

- HCM-F (if installed)
- Cisco Unified CM
- Cisco Unity Connection
- LDAP
- WebEx

Individual add, update and delete operations carried out by a data sync instance can be disabled on the user interface. If no operation is selected, the default behavior is maintained.

Related Topics

- Sync Overview in the Best Practices Guide
- Data Sync Types in the Core Feature Guide

26.1.1. Data Sync Settings

The table describes a number of key settings that are available for data sync:

Model Type lists	<p>Define the entities to pull in a given sync. For example:</p> <ul style="list-style-type: none"> • Only pull in <code>device/cucm/User</code> records from Cisco Unified CM.
Model Instance filters	<p>Limit a sync to a subset of entities in a sync. For example:</p> <ul style="list-style-type: none"> • Pull in users with a primary extension starting with <code>1</code>. <p>A system-level administrator will need to expose this setting on the Admin Portal.</p>
Actions	<p>Select which actions are active for a sync (Add/Update/Delete).</p> <ul style="list-style-type: none"> • Update requires more effort to run because this typically involves a GET API call for each record, which must then be compared to VOSS-4-UC data. • Add/Delete can be determined from the initial list API calls. <p>To save time on the sync, you may wish to disable Update if you only require Add/Delete.</p>
Quick Import	<p>Uses the list API responses to update the VOSS-4-UC cache, and won't perform individual GET calls for each entity for the update. Recommended when the list response contains all values for the entity, or where only the key settings must be updated. Removing individual GETs speeds up the sync, since VOSS-4-UC is not waiting for the API responses when there are a many entities to update. This is useful if the list and GET responses are required, or if you only need the summary data from the list view.</p>

Note: Quick Import is generally not recommended, and should be used only for syncing `device/cuc/ImportUser`.

However, *initially* there is an exception to the performance improvement of a Quick Import sync with `device/cuc/User`:

- When quick import is turned on a sync that has previously run without it, dependent, non-Import User model types use the LIST response data to compare with the resource data that was originally saved using the GET response data.
- The data sync detects a change, and initiates a resource save for each instance.
- For `device/cuc/User`, dependent import API calls are made, resulting in a long sync time.
- Once it completes, *subsequent* quick import syncs should show an improvement over non-quick import syncs. When changing back to a non-quick import sync, the same effect would likely be observed.

26.1.2. Synchronous and Asynchronous Data Sync

By default, a data sync is asynchronous; that is, other tasks can be carried out while the sync is in progress. However, a data sync can be set to be synchronous so that a workflow step can, for example, wait for the sync process to complete.

Asynchronous imports initiated by a Data Sync are standalone transactions; that is, they aren't child transactions of the Data Sync execute transaction. Synchronous imports initiated by a Data Sync are children of the Data Sync execute transaction.

26.2. Default Cache Control Policy

A default Cache Control Policy is applied to manage the caching behavior of the system, in other words, it controls how data is read.

The defaults are set as follows:

- Cache Policy for Reads: read from cache then device
- Read Before Write: On Update
- Read After Write: On Add
- Read After Write: On Update
- Model specific overrides:
 - Model Type: `device/notification_service/*`
 - * Cache Policy for Reads: Cache

The following concepts apply:

- Cache only: Unless overridden within the request, instance reads via the API always return the cached version of data. There is no need for the client to query the uncached instance data.
- Cache then device: The API will return the cached data, the Admin Portal will indicate that the data shown is cached and will automatically make an API call requesting non-cached data. It is up to external clients to query the data requesting non-cached data. If this option is selected, data is loaded into the system in two steps:
 1. Load cached data
 2. Load device data

The 'cached' visual indicator is displayed until the second step is complete.

The device data overrides the previously displayed data unless the user has made an input:

- a. The fields changed by the user will reflect the user's input and not the device data.
- b. Arrays are blocked for the duration of the device data loading (while the 'cached' flag is displayed) and the user can not add or remove elements until the device data loading completes.

Data is validated constantly as displayed values change, and validation status always reflects the very latest state.

- Manual: Unless overridden within the request, instance reads via the API always return the cached version of data. An external client using the API needs to provide a button to allow the user to manually retrieve non-cached data.
- No cache: Unless overridden within the request, instance reads via the API always return the uncached version of data that is queried from the device. In this mode the Admin Portal will not show any data until it is retrieved from the device.

For Relation model types, the relation's cache control policy will filter down to the joined device models. For example:

- If the cache control policy of a Relation is Cache then Device, any GET operations that do not specify the cached parameter will return a cached result. It then becomes the client's responsibility to make another request with `cached=false`.
- If the cache control policy of a Relation is Cache only or Manual, then any GET requests that do not specify the cached parameter, return cached data for all joined models.
- If the cache control policy on read is No cache, the Relation will always fetch the latest device data.

26.3. Data Sync Types

VOSS-4-UC provides the following data sync types:

Data sync type	Description
Pull from Device	Available to all device types. <ul style="list-style-type: none"> • Pull all data from the device • Pull only the schema from the device (used for LDAP) • Pull data from the Change Notification Feature local data collection
Purge Local Resources	Available to all device types. <ul style="list-style-type: none"> • Purge data from the cache
Push to Device	Available only to Cisco Unified CM devices <ul style="list-style-type: none"> • Push data in the cache to the device
Change Notification Sync	Available only to Cisco Unified CM devices

Note: A quick import option is available to fetch only summary data that is contained in a list operation

response and not the data for all instances/fields. See Data Sync Overview in the Core Guide for details.

Generally, for all sync types, VOSS-4-UC builds up the lists of entities from both VOSS-4-UC and the device, and compares them, using the key for the device entity. The key is typically the unique identifier (ID) for the record in the device we're syncing with. For example, for Unified CM, the ID is the *pkid*, which is the internal Unified CM database ID.

For subscribers, a sync builds up the list of `device/cucm/Users` in VOSS-4-UC and then requests from the Unified CM the lists of users it currently has for the comparison. Differences in the lists are handled according to each sync type.

Related Topics

- Data Sync Overview in the Core Feature Guide
- Change Notification Feature Overview in the Core Feature Guide

26.3.1. Pull from Device

For sync type *Pull from Device*, the VOSS-4-UC resource is updated where the same key is present in both lists. In this case, the device data is the master and the VOSS-4-UC system model data is updated with the device data.

For example, let's say new data is added to the Unified CM, so that the VOSS-4-UC system data state for a Unified CM `device/cucm/User` does not show instances that are shown on the Unified CM.

In this case, a *pull* data sync synchronizes the system data with the Unified CM data. For example, a user's Department may be updated on the Unified CM, but the update only shows on the system after a *Pull from Device* sync. If a user resource is created in Unified CM but not in VOSS-4-UC, this adds the `device/cucm/User` instance into VOSS-4-UC at the level the *pull* sync was run from, for example, at the customer level.

When deleting a VOSS-4-UC resource from the device, so that the key is in the VOSS-4-UC list but not in the device list, a *pull* sync removes the resource in VOSS-4-UC. For example, if the resource is a user in VOSS-4-UC but not in Unified CM, the *pull* sync removes the `device/cucm/User` record in VOSS-4-UC.

To restrict the number of records removed in VOSS-4-UC, ensure you have the following named macro at the hierarchy where the sync takes place:

```
PULL_SYNC_DELETE_THRESHOLD_<device_type>
```

For details, see Pull Sync Delete Threshold topic in the Advanced Configuration Guide.

When pulling device data, for example LDAP users from an LDAP device, the results returned to VOSS-4-UC depend on the LDAP server configuration. For example, if the returned results exceed the LDAP server configured maximum, and if the server does not support paging, an appropriate error message is returned.

26.3.2. Push to Device

Sync type *Push to Device* is available only to Cisco Unified CM device types.

In a *Push to Device* sync type, devices are synchronized with the VOSS-4-UC system data state, which is the primary data state.

- When deleting device data from VOSS-4-UC so that the key is in the *device* list but not in the VOSS-4-UC list (for example, delete user in VOSS-4-UC), the user is removed from Unified CM. The user will not exist on the device or on VOSS-4-UC.
- When adding new device data to VOSS-4-UC so that the resource shows instances that are not shown on the device, a *push* data sync synchronizes the device data with the VOSS-4-UC data. For example, adding a `device/cucm/User` instance to VOSS-4-UC and running a *Push to Device* sync adds the user record to Unified CM.

Keys found in both lists are ignored. Existing records are not updated in either direction.

In the `device/cucm/User` example, if the same user exists on both VOSS-4-UC and on Unified CM, no update occurs in either direction. Detailed settings may still not match after a *Push to Device* sync.

Important: When performing a *push* sync, it is important to consider data dependencies between different models.

For example, data dependencies may exist between users and phones in the Cisco Unified CM. In this case, if a user is associated to a phone (via the associated devices on the user), you can't add the user if the phone does not yet exist in in Cisco Unified CM.

On the other hand, for ownerID on the phone, pushing the phone first will fail since the user isn't in place.

This might mean running the *push* sync multiple times so it loads in the required order, or you may need to modify data (such as removing device association) to allow the *push* sync to succeed.

Note: The keys list sync logic described in this topic implies that in case of a reversion of the Unified CM to restores/inactive partitions, the end-state of the relevant pkids may differ to their state the last time VOSS-4-UC was in sync with Unified CM (before a restore), particularly if testing occurred in between. This means you may, for example, have a user with the same username in both VOSS-4-UC and Unified CM, but if that user's pkid in Unified CM now differs to the one in VOSS-4-UC from previous syncs or interactions, they will be seen as different users even though they have the same usernames.

26.3.3. Change Notification Sync

Sync type *Change Notification Sync* is available only to Cisco Unified CM device types.

A *Change Notification Sync* is a pull sync of changes stored in the local collection that is updated by the Change Notification Collector service.

For more details on Change Notification Sync, see the related topics in Data Sync section of the Core Feature Guide.

26.3.4. Purge Local Resources

In a *Purge Local Resources* sync type, all resources or instances of device information that exists in the system are deleted. Entities in the device are not deleted.

Note: The default *purge* syncs created when adding a CUCM, CUC, LDAP or CCX server type are disabled by default. To use the *purge* sync, the “Remove” check box must first be cleared on the “Disabled Operations” tab of the relevant sync.

This sync type is typically used when cleaning up the system. The system displays a warning before executing an enabled *purge* sync.

See the following sample device type syncs:

- HcsPurge-{{CUCMHostname}}-{{CUCMClusterName}}-DS
- HcsUserPurgeDS-{{CUCMHostname}}-{{CUCMClusterName}}
- HcsPhonePurgeDS-{{CUCMHostname}}-{{CUCMClusterName}}
- HcsPurge-{{CUCXHostname}}-{{CUCXClusterName}}-DS
- PurgeUccx-{{UCCXHostName}}
- HcsLdapUserPurge-{{UniqueID}}
- PurgeSpark{{CustomerName}}

26.4. Full Sync

A full pull sync, when runs, empties the changes from the data collection as they don't need to be processed by the Change Notification Sync. Use the disabled operations and the model type list of the full sync to filter the changes to remove. If a model instance filter is included, no changes are removed.

26.5. Enable a Scheduled Data Sync

By default, when a Cisco Unified Communications Manager or Cisco Unity Connection device is set up in VOSS-4-UC, a full data sync instance is created to perform the initial sync of all data from the device. A Change Notification Sync type also gets created in the Data Sync page. In addition, a Schedule is created to execute that data sync every 14 days, but is disabled by default. We recommend running the full data sync manually only when necessary. However, if a regularly scheduled sync is desired, the schedule can be enabled as follows:

Perform these steps:

1. Log in as provider administrator.
2. On the **Scheduling** form (default menu **Administration Tools > Scheduling**) choose the schedule instance that matches this naming convention:

HcsSync-<ip_address>-<device_name>-SCHED. For example:

HcsSync-192.0.2.24-CUCM01-SCHED

3. Select the **Active** check box.
4. Click the **Multiple Executions** tab, and update the interval, if desired.
5. Click **Save**.

The full data sync executes immediately, and executes again according to the schedule.

26.6. Manually Run the Default Data Sync

You can always manually run the default data sync when there have been updates to Cisco Unified Communications Manager (CUCM) or Cisco Unity Connection (CUC) devices that need to be synced into VOSS-4-UC.

Note: Manually running the change notification sync is not supported.

Perform these steps:

1. Log in as provider or reseller administrator.
2. Go to (default menu **Device Management > Advanced > Perform Publisher Actions**).
3. From the **Action** drop-down, choose **Import**.
4. From the **App Type** drop-down, choose **CUCM Device** or **CUC Device**.
5. From the Clusters **Available** box, choose the device, move it to the **Selected** box, and click **Save**.

26.7. Controlling a Data Sync with a Model Type List

Using a Model Type List (MTL), you can control the types of data that are synced into VOSS-4-UC from Cisco Unified Communications Manager or Cisco Unity Connection devices. Controlling the types of data that are synced can greatly improve sync performance. The MTL is a list of device models associated with the device type, for example, Phone and Line device models that are associated with the Unified CM device.

These are the possible types of Model Type Lists:

- **Include Selected Model Types** - This list represents the device models to explicitly include in the data sync.
- **Exclude Selected Model Types** - This list represents the device models to explicitly exclude from the data sync.
- **Ordered List** - This list represents the device models to explicitly include in the data sync in the order they must be synced.

A data sync created with an empty Model Type List attribute results in the subsequent import(s) synchronizing all device models for the corresponding device.

Here's an example of an include MTL:

The screenshot shows a web form titled "Model Type List [HCS CUCM Media MTL]". At the top right, there are buttons for "Save", "Delete", "Help", "Back", and "Action". The form contains the following elements:

- Name***: A text input field containing "HCS CUCM Media MTL".
- List Type***: A dropdown menu with "Include Selected Model Types" selected.
- Model Types**: A table with a header row containing a plus sign (+) and a minus sign (-). Below the header, there are five rows, each with a set of navigation icons (minus, plus, up, down) and a text input field containing a model path:

Model Types	
- + ▾ ▾	device/cucm/MediaResourceGroup
- + ▲ ▾	device/cucm/MediaResourceList
- + ▲ ▾	device/cucm/MohServer
- + ▲ ▾	device/cucm/MohAudioSource
- + ▲	device/cucm/Mtp

A data sync using this MTL will sync all Media Resource Group, Media Resource Lists, Music on Hold servers and audio sources, and Media Termination Points. No other data will be synced from Unified CM.

It is recommended to define MTLs for sets of data that are being modified on the device directly, particularly Unified CM because this is where the bulk of the configuration data for each customer resides. By defining MTLs that target specific data sets rather than doing a full sync, the performance of VOSS-4-UC can be maintained with better response times and quicker transaction execution. Some Unified CM device models to avoid unless needed are Users, Phones, and Lines, as there may be large numbers of these in the Unified CM and result in a lengthy data sync operation.

Data sync overhead can be further reduced if you want to sync only new and deleted instances of the device model and not updates to existing instances. This can be done by unchecking the Refresh Existing (Changed) Data check box on the Data Sync configuration page. This check box controls whether existing device model instances are updated in VOSS-4-UC in addition to importing new instances and removing deleted instances. If checked, all device model instances must be synced and examined. If unchecked, only new and deleted instances need to be imported and the data sync will run considerably faster.

26.8. Create a Targeted Model Type List

If you manage data on Cisco Unified Communications Manager (Unified CM) or Cisco Unity Connection directly on a regular basis, perhaps for configuration that is not orchestrated from VOSS-4-UC, such as media resources, it is recommended to create a Model Type List and Data Sync specifically targeting the data items you are managing. This ensures each data sync is highly optimized for the data being changed on Unified CM directly and minimizing the load on VOSS-4-UC. To create a targeted Model Type List:

Perform these steps:

1. Log in as Provider level admin or higher.
2. Access the **Model Type List** form (default menu **Administration Tools > Model Type List**) and click **Add**.
3. Specify the name of the Model Type List.

It is recommended to use a naming convention that makes it easy to identify the MTL in a list view, such as Unified CM Media Resources.

4. From the **List Type** drop-down, choose the list type:

- Choose **Include Selected Model Types** if the list of device models you want to sync is relatively short.
- Choose **Exclude Selected Model Types** if the list of device models you want to sync is relatively long. Exclude device models that tend to have lots of instances, like users, phones, and lines.
- Choose **Ordered List** if the list of device models you want to sync is relatively short and the order in which they are synced matters.

Note: A data sync will fail if the **List Type** of the Model Type List does not match the **Device Type** of the Data Sync.

5. Add Model Types to the list of device models that are to be included or excluded according to the **List Type** selected.

See [View List of Device Models](#) for information on how to see a list of available Unified CM and Cisco Unity Connection device models.

6. Click **Save**.

26.9. Model Instance Filter

The model instance filter (MIF) capability allows the administrator to provide criteria to define a subset of model instances to sync in. This causes the sync to only sync in those instances matching the criteria instead of all the instances.

A data sync can be set up with reference to:

- the device that is the sync target
- a set of data in the form of a model type list, that also defines the sync sequence of the models in this list
- model instance filters of the models in the list - to provide more specific filtering of specific instances of the models to sync

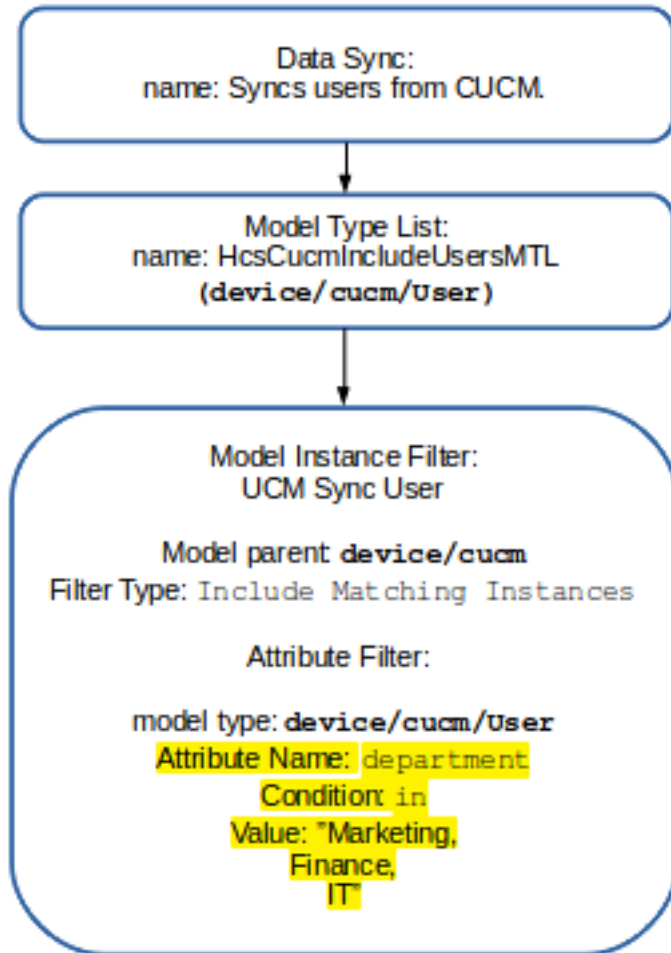

26.9.1. Add a Model Instance Filter

1. Log in as a Provider level administrator and open the **Model Instance Filter** form (default menu **Administration Tools > Model Instance Filter**) to display the list view of existing filters at the corresponding administrator hierarchy.
2. Click **Add** and enter a **Name** for the filter.
3. From the **Model Parent** drop-down choose the device or model type. The filter will be applied to it.

Note: A data sync will fail if the **Model Parent** of the Model Instance filter does not match the **Device Type** of the Data Sync.

4. Choose the type of filter - the inclusion or exclusion of attributes: **Include Matching Instances** or **Exclude Matching Instances**.
5. Add one or more filters in the **Model Filters** group:
 - a. Choose the **Model Type** that belongs to the **Model Parent**.
 - b. Add one or more attribute filters in the **Attribute Filters** group:

- The **Attribute Name** should be selected after inspecting list request responses in the Transaction log - refer to the note below.
- Choose its **Condition**.
- Provide a **Value** to filter on.

Filter criteria can be set up according to your purposes:

- Multiple **Model Type** entries are treated as an OR condition; creating a list of criteria. Any records matching any of the entries will result in a match. This is useful when defining criteria for different model types, for example, criteria for user records and different criteria for phone records. It is also useful for defining multiple criteria on the *same* model type and attribute, for example, multiple entries for `device/cucm/User` model type where the attribute of `userid` for example matches different macro-based conditions.
- Multiple **Attribute Filters** - attribute criteria for a model type are treated as a logical AND condition and entries need to match *all* the criteria in order to meet the condition. This is useful when creating criteria that match multiple different attributes of the model type, for example, match a user that has a matching `userid` as well as a matching `department`.

6. Click **Save**. The filter can be selected from the **Model Instance Filter** drop-down when creating or modifying a Data Sync.

Note:

- If the filter is added at a hierarchy level *below* that of the the Data Sync, executing the Data Sync will fail, displaying a message “Model type list <ModelTypeList> not found at or above the current hierarchy.”
- In order to identify the **Attribute Name** of the model that can be used for a filter, inspect the transaction log for a list request of the model from the device.

For example, in order to find the available Model Instance Filter attributes of `device/cucm/UserProfileProvision`, inspect the response from a list request from the device.

From the RESPONSE snippet below, it can be determined that the attributes available for filtering are:

- name
- description
- allowProvision
- limitProvision

```

</ns0:listUserProfileProvision>
</soapenv:Body>
</soapenv:Envelope>

RESPONSE:
<soapenv:Envelope xmlns:soapenv="http://schemas.xmlsoap.org/soap/envelope/">
  <soapenv:Body>
    <ns:listUserProfileProvisionResponse xmlns:ns="http://www.cisco.com/AXL/API/11.5">
      <return>
        <UserProfileProvision uuid="{96FA39CD-8A29-4B26-A3F5-0FF683326134}">
          <name>Standard (Factory Default) User Profile</name>
          <description>Standard (Factory Default) User Profile</description>
          <allowProvision>>false</allowProvision>
          <limitProvision>10</limitProvision>
        </UserProfileProvision>
      </return>
    </listUserProfileProvisionResponse>
  </soapenv:Body>
</soapenv:Envelope>

```

26.9.2. Common Use of Model Instance Filters

While model instance filters can be used on any sync type, their common uses are:

- On add syncs - to retrieve a subset of records from the underlying device into VOSS-4-UC. For example, to limit the users pulled from LDAP, from UCM, and so on.
- On delete/purge sync - to target specific records for removal in a purge or delete sync. For example, to purge a subset of users from VOSS-4-UC that were inadvertently pulled in.

Note: Model Instance filters do not work with Cisco UCM Change Notification sync types. If a model instance filter is needed for a UCM element, this model type should be excluded from the change notification sync and a separate sync should be set up for this.

26.9.3. Macro Functions in Model Instance Filters

Macro functions can be used in the **Value** field to define matching criteria. This is particularly useful for “contains” matching, for example, using `fn.contains` or `fn.containsIgnoreCase`.

The value read in from the device API call can be referenced using the input context and the field name from the API call (for example, `input.telephoneNumber`).

For example, the **Value** field can have:

- for `fn.contains`:

```
((fn.contains Dublin, input.description == True)) <{{input.description}}>
```

This `fn.contains` function will search as *case sensitive*, and in the example will only match where the description field contains the word “Dublin”.

- for `fn.containsIgnoreCase`:

```
((fn.containsIgnoreCase +27, input.telephoneNumber == True)) <{{input.
→telephoneNumber}}>
```

You can also use a named macro (e.g. `macro.ZA-number`), that has the macro above in the **Value** field instead, so that:

- **Model Type:** `device/cucm/User`
- **Attribute Name:** `telephoneNumber`
- **Value:** `macro.ZA-number`

This condition will sync every user with a telephone number that includes `+27`.

Macros cannot be used in the **Value** field in conjunction with the “in” **Condition**.

26.10. Model Instance Filter Examples

1. A MIF with multiple Model Filter entries to match criteria on different model types:

The screenshot shows a configuration interface for a Model Instance Filter (MIF). The main configuration area includes:

- Name*:** UCM Sync User and Phone Criteria
- Model Parent:** device/cucm
- Filter Type*:** Include Matching Instances

Below the main configuration, there are two entries in the **Model Filters** list:

- Filter 1:**
 - Model Type*:** device/cucm/User
 - Attribute Filters:**
 - Attribute Name*:** department
 - Condition*:** In
 - Values:** Marketing, Finance, IT
- Filter 2:**
 - Model Type*:** device/cucm/Phone
 - Attribute Filters:**
 - Attribute Name*:** product
 - Condition*:** Equals
 - Value:** Cisco 7940

This will result in: looking at `device/cucm/User` records it will match users that have a department of Marketing, Finance, or IT (due to the IN condition). When looking at `device/cucm/Phones` it will match phones of the type “Cisco 7940”.

2. A MIF with multiple Model Filter entries with the same model type and macros to create a list of records to match

The image displays two screenshots of a Model Instance Filter configuration interface. Both screenshots show the 'Model Type*' dropdown set to 'device/cucm/User'. The 'Attribute Filters' section is expanded to show a single filter for the 'telephoneNumber' attribute with the condition 'Equals'. The 'Value' field in the top screenshot contains the macro `{{ fn.containsIgnoreCase +1,input.telephoneNumber == True}}`, while the bottom screenshot contains `{{ fn.containsIgnoreCase +27,input.telephoneNumber == True}}`.

When looking at the `device/cucm/User` records it will match users that have a telephone number containing +1 OR +27. The macro in the value field is cut short but it's using the macro in the notes above for reference. Due to the macros in use in the value, this had to be done as multiple model filter entries instead of a attribute filter using the IN condition.

3. A MIF with multiple attribute filters applied to the same model type

Model Type*

Attribute Filters

Attribute Name*

Condition*

Values

Attribute Name*

Condition*

Value

When looking at the `device/cucm/User` records it will match users that have a department matching Marketing, Finance, or IT, AND has the home cluster flag set to true.

26.11. View List of Device Models

Use this procedure to see the device models available to use in Model Type Lists for custom data syncs from Cisco Unified Communications Manager or Cisco Unity Connection.

Perform these steps:

1. Log in as an administrator above provider level.
2. Click the ? on the menu bar to open Online Help.
3. Select Model API.
4. Select Device/Cuc or Device/Cucm. All the applicable device models are listed for the selected device.

Next Steps

When including the device model in a Model Type List, use the format: `device/<device_type>/<device_model>`. For example, `device/cucm/BillingServer`.

26.12. Create a Custom Data Sync

Create a custom data sync to use a targeted Model Type List.

Perform these steps:

1. Log in as provider admin or higher.
2. Choose **Administration Tools > Data Sync**.
3. Click **Add**.
4. Enter the name of the Data Sync in the **Name** field.

It is recommend to use a naming convention that makes it easy to identify the data syncs in the list view, such as C1Pull-CUCM01-DS where C1 is the customer name, Pull is the data sync type, CUCM01 is the name of the Cisco Unified Communications Manager, and DS stands for Data Sync. You could also include the type of data included in the sync, such as C1Pull-CUCM01-MediaResources-DS.

5. From the **Device Type** drop-down, choose the Device Type you are syncing from.
6. From the **Sync Type** drop-down, choose **Pull from Device**.
7. From the **Dependency Resolution** drop-down, choose **Default**.
8. Select the **Execute Asynchronously** and **Refresh Existing (Changed) Data** check boxes.
Execute Asynchronously means that the sync request will return a reply before its complete when executed from the API. Refresh Existing (Changed) Data means that all instances of the device models specified in the Model Type List will be updated.
9. Select the **Force Refresh of Data** check box if a data update is required regardless of whether data has changed on the device. This option would for example be used if it is required that update workflows be run upon a data sync.
10. From the **Model Type List** drop-down, choose the targeted Model Type List you defined earlier.
11. Leave **Synchronization Order** and **Model Instance Filter** blank.
12. Click + next to **Device Filters** to add an entry to the list.
 - a. From the **Attribute Name** drop-down, choose **host**.
 - b. From the **Condition** drop-down, choose **Equals**.
 - c. From the **Value** drop-down, choose the hostname/IP address of the device.

Note: Workflows can be added to, and executed by a custom data sync to perform specific data sync operations.

13. In the **Workflows** section, include workflows in the custom data sync if you want to perform specific data sync operations, otherwise leave the **Workflows** section empty. For example, if you want to move remote destinations from the Customer hierarchy level to the Site level, choose the **RD_Overbuild_PWF_wrapper** workflow from the **Workflow** drop-down.

14. From the **Transaction Log Level** drop-down, choose the log level for the data sync. For a description of the list of log levels, see [Transaction Log Levels](#). The default log level is *Warning*.

You can for example reduce the log level for PULL device syncs in order to reduce the size of transaction logs. This is useful where large numbers of transactions are archived regularly.

15. Click **Save**.

Next Steps

To run the custom data sync, click the data sync from the **Data Sync** list and click **Execute**.

26.13. Unified CM Change Notification Feature Alerts

The Unified CM Change Notification Feature (CNF) is enabled to display alerts. You don't have to configure the change notification feature alerts manually in the VOSS-4-UC. The administrator gets the alerts when something goes wrong with the collector process.

The administrators can view the alerts at the hierarchy level they log in and all the levels below that hierarchy. For example, if an alert is raised at the customer level (sys.hcs.provider.reseller.customer), then the provider, reseller, and customer administrators can see that alert but not site administrator. A Site administrator doesn't have access to view the alert. All the administrators have read and delete permissions to the alerts.

When a change notification feature alert is raised, the Messages indicator on the VOSS-4-UC Admin Portal shows the alert. Clicking the **Messages** or **Notifications** button on the toolbar shows a pop-up and a message that alerts have been raised. Clicking on the message, the user is navigated to the list of alert messages on the **Alerts** list view (default menu **Administration Tools > Alerts**).

CNF alerts have the following distinct properties:

- ID: A generated identifier of the target device of the collector For Unified CM, the ID shows the host name, port, and hierarchy
- Code: An error or warning code associated with the alert
- Category: The category of the alert - Device Change Notification Collector
- Severity: VOSS-4-UC displays severity codes and messages as follows (“{}” indicate device or number placeholders in the messages). Each alert has some properties, for example, severity (Error, Warning or Info), the number of times that the same alert has been raised, and the time stamp of the last alert instance.
- Message: Displays error message description and the statement to fix the error.
- Count: Displays the number of times the alert has occurred for a specific device.
- Latest Alert: Displays the last time this alert occurred.

Note: Administrators can also filter alerts by any of the alert fields.

VOSS-4-UC displays change notification feature alerts for the following error scenarios:

- Warning:
 - 45000: Unprocessed changes at 75% of limit for device {}. Please configure and run the necessary data syncs.

- Error:
 - 40000: Device change notifications are not supported for device {}.
 - 40001: Device change notification data for device {} has been lost. Tracking data has been repaired and collector process will continue. Some changes may have been lost, please run a full sync on the device.
 - 40002: Device change notification tracking data for device {} has become corrupted. Tracking data has been repaired and collector process will continue. Some changes may have been lost, please run a full sync on the device.
 - 40003: Device change notification tracking DB write for device {} failed. The collector process will continue to attempt DB writes. Please investigate the database write failure.
 - 40004: Device change notification data DB write for device {} failed. The collector process will continue to attempt DB writes. Please investigate the database write failure.
 - 40005: Unable to repair device change notification tracking data for device {}.
 - 40006: Too many unprocessed changes recorded for device {}. No new changes will be recorded until at least {} changes are processed. Please configure and run the necessary data syncs.
 - 40008: Could not update pending changes data for device {}. {}.

The administrator reads, inspects, acts on (for example, run a full sync on the device), and then manages alerts of the Change Notification collection service. The administrator can delete the alert from the list only when the issue that raised the alert has been resolved.

Note: If the Administrators forget to remove the change notification feature alert after resolving it, the alert will still be shown when they log in to VOSS-4-UC. We strongly recommend removing the alert after resolving it.

26.14. Change Notification Sync

26.14.1. Change Notification Feature Overview

The VOSS-4-UC interaction with the UCM Change notification sync has two primary components:

- Data Collector - collects the changes from the Cisco Unified CM and updates the VOSS cache on the configured frequency (defaults to every 300 seconds). This collector must be enabled to collect the changes, otherwise the sync will not process any changes.
- Change Notification Sync - this is a type of sync that processes the changes the collector puts into the VOSS cache. A scheduled sync should be set up and enabled so that the changes are processed within a reasonable period. The sync can also be run adhoc if required around the schedule.

The VOSS-4-UC data collector retrieves the change records from the Cisco Unified CM on the configured interval. For example, this could be every 300 seconds (5 minutes) which is the default. When a Change Notification Sync type is run, VOSS-4-UC processes the change records collected. VOSS-4-UC then processes the records accordingly:

- Add - will do a GET API call to retrieve the full record and add it to VOSS-4-UC.
- Update - will do a GET API call to retrieve the full record and update the record in VOSS-4-UC.

- Del - will remove the record from VOSS-4-UC.

The efficiency on these Update syncs is because there is no need to do a GET API call for every single record in the system - only for those that changed. In large UC application installations, this can make a big difference in Update sync times.

For example, with a data collector polling period of 300 seconds and a CNF sync scheduled for every 24 hours, the process would work as follows:

- Every 300 seconds (5 minutes) the polling collector would get all the current changes from Cisco Unified CM.
- This polling would repeat every 5 minutes - updating the VOSS-4-UC cache.
- After 24 hours, the CNF sync would run and process all the changes VOSS-4-UC stored over that 24hr period. The duration of this sync will depend on the number of changes to process, since each requires an AXL GET API request.

This type of sync, especially for updates, is far more efficient, because a GET AXL request for every object in the system is not required - only for those that changed in the time between syncs.

On a system with 10000 users for example, if 100 of the users were changed, then only 100 GET AXL request are needed. By contrast, a normal sync doing an update would require 10000 GET AXL requests to update the same 100 users.

The VOSS-4-UC data collection can store up to 200,000 changes from a single Cisco Unified CM Cluster. A warning is raised when 75% of the data collection storage capacity is reached. When the 200,000 changes capacity for a cluster is reached, a sync error occurs on the user interface (see [Errors and Troubleshooting Change Notification Processes](#)) To avoid the sync error, we recommend always having a scheduled CNF sync running on a regular basis based on your needs when Change Notification is enabled.

26.14.2. Setup to Enable or Disable CNF for a Cisco Unified CM Cluster

The following steps are a checklist to enable change notification for a Cisco Unified CM cluster in VOSS-4-UC.

1. Ensure the Service is enabled and configured in Cisco Unified CM. ([Cisco Unified CM Setup to use CNF](#))
2. Enable Change Notification on the Cisco Unified CM cluster in VOSS-4-UC. ([VOSS-4-UC Change Notification Functionality](#))
3. Review the detailed Change Notification settings for the cluster. ([VOSS-4-UC Change Notification Functionality](#))
4. Review or create the required Data Sync instances for change notification for the cluster. Refer to the topics on Data Sync following [Data Sync Overview](#).

The number of syncs and their setup will depend on the needs for your system and the design.

See the Best Practices Guide for guidance on sync logic and recommended setups. If further recommendations or guidance is needed, contact your VOSS account team or VOSS support.

5. Review or create required schedules for the Data sync(s) created above and activate the schedule(s). ([Enable a Scheduled Data Sync](#))

Follow the guidance for scheduling around syncs to ensure the load on the system is optimized. At least one sync schedule should be activated for the CNF setup to be complete.

Follow the steps in reverse in order to disable change notification for the cluster.

26.14.3. Detailed Cisco Unified CM CNF Functionality

The change notification capability supports all the objects that are available via AXL. In general, this means that everything VOSS-4-UC can manage in Cisco Unified CM will be available via change notification.

Data that VOSS-4-UC pulls from Cisco Unified CM that is *not* via AXL, includes:

- `device/cucm/PhoneType` - this is a combination of thinAXL so would not auto-update. This includes when you add or update phone types in Cisco Unified CM with COP files or via Cisco Unified CM upgrades. So a non-CNF sync is still required for this model.
- Phone Status and IP Address - this is pulled into the system when the phones are viewed in VOSS-4-UC (list view or individual phone). This is not via AXL so would not be updated via change notification or even a normal sync at this point.

In Cisco Unified CM, the change queue cache is stored in memory and is limited to 100,000 changes. The cache can fill quickly depending on the types of changes performed. For example, if an XSI (IP Phone) Service has been configured for 10,000 phones and the service is deleted, the cache will include one entry representing the deletion of the service plus 10,000 phone updates indicating the service was removed from each device. The polling period from the Cisco Unified CM is configurable and the timing should be considered based on how frequent configuration changes are being made in Cisco Unified CM. The default in VOSS-4-UC when polling is enabled is 300 seconds but it can be modified to be longer (up to 7200 seconds) as desired.

Cisco Unified CM Setup to use CNF

There are two settings in the Cisco Unified CM to check and update to ensure Change Notification is enabled and set up for the right queue size (accessed via service parameters: - **System > Service Parameters > Cisco Database Layer Monitor** then click the **Advanced** button):

Service Parameter Name	Setting
AXL Change Notification	This should be set to "On"
AXL Change Notification Queue Size	This has a default of 20000. For a typical system, it is suggested this is changed to the maximum of 100000 to reduce the chance of changes being missed under heavy provisioning tasks.

26.14.4. VOSS-4-UC Change Notification Functionality

This section provides more details on the functionality of the Change Notification Feature (CNF) components in VOSS-4-UC.

Change Notification Collector

The `data/DeviceChanges` model has an instance per UCM cluster and will provide the data collector status and pending changes in the cache for that cluster. An instance of the model will appear for all UCM clusters whether change notification is enabled or not. It gives you access to:

- **Base** tab
 - **Last Collection Time** - time the changes were last collected from the device
 - **Pending Change Notifications** - a view of pending changes collected for different types of models and by type of change (Add/Update/Delete). By default, this is `device/cucm/User`, `device/cucm/Line` and `device/cucm/Phone`. However, these models are adjustable on the **Settings** tab. If additional model types to the defaults above are added to the list, these are also shown. The remaining model types are all grouped in a single row called `Other`.
- **Settings** tab
 - **Polling Interval (seconds)** (300-7200 seconds with default 300) - the duration for collection of changes from the device
 - **Enable Change Collection** - enable or disable the change collector for that device.
 - **Ignored Operations** - you can select certain operations (Add/Mod/Del) to not be collected. Typically you want to collect all changes; however this option can be used to ignore some changes for specific scenarios if needed (for example, you will only handle updates via the CNF sync).
 - **Displayed Model Types** - here you can configure which models you want to see summary stats for on the **Base** tab. You can add, remove or change models to meet specific needs (for example, `deviceProfile` for extension mobility profiles, `remoteDestination` for SNR remote destinations, and so on).

The `data/DeviceChanges` model should be included in menu layouts for roles that need access to this level of detail for the CNF syncs.

Change Notification Sync Type

When a Change Notification Sync type is used in a data sync, there are a number of differences in the sync behavior in comparison with a normal pull sync:

- A GUI portal rule on the Data Sync interface will change some of the settings visible on the Data Sync GUI interface when the **Sync Type** is set to Change Notification Sync. This selection hides settings that are not relevant and exposes new settings for this type only.
- **Number of Changes to Process** - This input field becomes available from the Data Sync interface. Leaving the input box blank or typing in 0 will mean the sync will process all the pending changes collected - subject to the selected model type list and Disabled Operations set up on the sync. If you enter a number, the sync will process that number of changes only and leave any additional changes in the change collection for the next sync.

Typically this value should be 0 or blank, unless there is a specific reason to limit the number of changes to process, for example when managing how long the sync may run.

All other visible settings are the same as with a normal pull sync, for example, device filters, workflows, and so on.

When a sync runs (either a normal pull sync or a change notification sync), it will clear out the change notification collection of any model types and changes processed for that cluster.

The model type lists and disabled operations define which models and types of actions are processed in either a pull or a change notification sync:

- The model type list (if one is assigned) assigned to the sync will determine which model type changes will be processed from the collected changes (for example, `device/cucm/User` for user entities only).
- The **Disabled Operations** tab defines if any of the types of changes are ignored. For example, selecting **Remove** will ignore delete changes.

Pull Sync and Change Notification Sync details:

- A pull sync does not utilize the change notification collection as a source of data. However, it will clear the collection for the models types it processes.
 - A *full* pull sync (a pull sync without a model type list) will clear the change collection as part of the sync process since it is pulling *all* the latest information from the UCM.
 - A pull sync with a model type list defined (for example one that contains `device/cucm/User`) will clear the change collection of any `device/cucm/User` changes, since it is syncing all the user information anyway. All other model types and changes will be left in the collection.
 - If a pull sync is run with **Disabled Operations** selected (for example, **Add** is selected) this will process the pending changes for Update and Delete actions for any matching models. However, *all* actions for the matching model will be cleared from the cache, *including Add actions*.
- A Change Notification Sync utilizes the change collection as its source of information and will clear that changes from the change collection for any model types it is processing.
 - A *full* Change notification sync (CNF sync without a model type list) will process *all* the pending changes and clear the change collection (unless limited by a value in the **Number of Changes to Process** setting on the sync. Then only that number of changes will be processed and cleared).
 - A change notification sync with a model type list defined (for example contains `device/cucm/User`) will process all the pending changes for the `device/cucm/User` model type and clear those from the change collection.
 - If a change notification sync is run with **Disabled Operations** (for example, **Add** is selected), it will process the Update and Delete changes for the matching models. However, *all* actions for the matching model(s) will be cleared from the cache, *including Add actions*.

This sync behavior means that you may wish to set up multiple syncs for a cluster to handle different types of sync and sync schedules to meet your needs. Ensure that you generally have all the model types covered in your scheduled syncs if CNF is enabled, otherwise some changes may never be cleared from the change collection, thereby taking up space.

For additional considerations and information around sync setup best practices, see the Best Practices Guide.

VOSS-4-UC Setup to enable Change Notification

Enabling the Change Notification capability is completed on a per UCM Cluster basis. This can be done on the UCM Server configuration page for a publisher via the publisher tab and selecting the **Enable Change Notification Sync** check box. When selected and saved, the system will:

- Enable the data collector for that cluster
- Create a CNF sync type for the cluster
- Create a schedule for the CNF sync. The schedule will be disabled by default.
- These settings should all be reviewed, adjusted, or additional instances created to meet your needs. See further information in:
 - The Best Practices Guide

- The System Monitoring Configuration section in the Advanced Configuration Guide on sync best practices for different scenarios and other considerations.
- A full sync with the UCM Cluster should be executed just before or after enabling Change Notification for the cluster. This can be part of changing the setting for an existing cluster or adding a new publisher. Currently, both actions will invoke a full sync of the cluster. However, if the sync is not completed during the add/modify of the publisher, then one should be initiated.

When CNF is disabled on the Publisher configuration page (or if the cluster is removed from the system), the following will occur:

- The auto-generated schedule that was added during enabling will be removed. Any additional custom scheduled added will not be removed automatically and should be removed before disabling the change notification for the cluster to avoid unnecessary syncs running.
- The auto-generated CNF sync type that was added during enabling will be removed. Any additional custom CNF sync types for the cluster added will not be removed automatically and should be removed before disabling the change notification for the cluster to avoid unnecessary syncs being set up.
- The data collector for the cluster will be disabled.

Note: If the collector is only disabled via the `data/DeviceChanges` model, then the schedules and sync will remain. This is the best approach if you need to temporarily disable the CNF sync (for example, for a maintenance window).

26.14.5. Errors and Troubleshooting Change Notification Processes

A number of scenarios may result in error conditions in the change notification process. The VOSS-4-UC system is enabled to display alerts automatically in this case, so that it is not necessary to configure the change notification feature (CNF) alerts manually.

Administrators can view the alerts at the hierarchy level they log in at and all the levels below that hierarchy. For example, if an alert is raised at the customer level (`sys.hcs.provider.reseller.c1`), then the provider, reseller, and customer administrators can see that alert, but not the site administrators. All the administrators have read and delete permissions to the alerts.

When a change notification feature alert is raised, the Notifications indicator on the VOSS-4-UC Admin Portal shows the alert. Clicking the Notifications button shows a pop-up and a message that alerts have been raised. By clicking on the message, users are directed to the list of alert messages which can also be accessed via the menu under **Administration Tools > Alerts**.

CNF alerts have the following distinct properties:

- ID: A generated identifier of the target device of the collector For Unified CM, the ID shows the host name, port, and hierarchy.
- Code: An error or warning code associated with the alert.
- Alert category: The category of the alert - Device Change Notification Collector
- Severity: VOSS-4-UC displays severity codes and messages as follows (“{}” indicate device or number placeholders in the messages). Each alert has some properties, for example, severity (Error, Warning or Info), the number of times that the same alert has been raised, and the time stamp of the last alert instance.
- Message: Displays error message description and the statement to fix the error.
- Count: Displays the number of times the alert has occurred for a specific device.

- Latest Alert: Displays the last time this alert occurred.

Note: Administrators can also filter alerts by any of the alert fields.

VOSS-4-UC displays change notification feature alerts for the following error scenarios:

- Warning:
 - 45000: Unprocessed changes at 75% of limit for device {}. Please configure and run the necessary data syncs.
- Error:
 - 40000: Device change notifications are not supported for device {}.
 - 40001: Device change notification data for device {} has been lost. Tracking data has been repaired and collector process will continue. Some changes may have been lost, please run a full sync on the device.
 - 40002: Device change notification tracking data for device {} has become corrupted. Tracking data has been repaired and collector process will continue. Some changes may have been lost, please run a full sync on the device.
 - 40003: Device change notification tracking DB write for device {} failed. The collector process will continue to attempt DB writes. Please investigate the database write failure.
 - 40004: Device change notification data DB write for device {} failed. The collector process will continue to attempt DB writes. Please investigate the database write failure.
 - 40005: Unable to repair device change notification tracking data for device {}.
 - 40006: Too many unprocessed changes recorded for device {}. No new changes will be recorded until at least {} changes are processed. Please configure and run the necessary data syncs.
 - 40008: Could not update pending changes data for device {}. {}.

The administrator reads, inspects, acts on (for example, run a full sync on the device), and then manages alerts of the Change Notification collection service. The administrator can delete the alert from the list only when the issue that raised the alert has been resolved.

Note: If the Administrators forget to remove the change notification feature alert after resolving it, the alert will still be shown when they log in to VOSS-4-UC. We strongly recommend removing the alert after resolving it.

Change Cache Full on Cisco Unified CM

If the Cisco Unified CM maximum number of stored change records is exceeded (see detailed Cisco Unified CM functionality section for more details on the limit and configuration) then the Cisco Unified CM will drop the oldest changes that have not been collected. This can happen if the polling time in VOSS-4-UC is set up to be too long or the Cisco Unified CM is experiencing a very high level of changes (see the detailed VOSS-4-UC functionality section for more details on polling configuration). When this situation occurs, VOSS-4-UC will get an error on polling and will try to recover. This activity is logged as an Alert in the system and provides the outcome - recovery was successful (alert code 40001 or 40002) or recovery was not successful (alert code 40005).

In the event the recovery was successful, you may want to review and consider a full sync as some changes would have been lost (the oldest changes in the Cisco Unified CM cache).

In the event the recovery was not successful, then a full sync is required to update and to get change notification functioning again. The full sync is needed as changes would have been missed from the Cisco Unified CM and we need to be at a clean sync in order to start processes changes again.

In this situation, application info log messages are logged as well - "Repaired change notification tracking data for device {}" or "Unable to repair change notification tracking data for device {}"

VOSS-4-UC Change Collection full for a Cisco Unified CM cluster

If the VOSS-4-UC change collection for a given Cisco Unified CM cluster exceeds the maximum changes - 200,000 - then an alert with code 40006 is raised. This alert means that no further changes are collected from the Cisco Unified CM until some of the pending changes are processed. This can be carried out by an administrator executing a sync for that Cisco Unified CM cluster to clear some of the changes. If the next scheduled sync is not too far ahead in time, then waiting for the next scheduled sync to run may be acceptable.

Other errors

The other error codes listed for the alerts are more internal in nature and should result in a VOSS support ticket being raised for further investigation.

27. Self Service Administration

27.1. Self Service Administration: Overview

In addition to the administration and configuration of various components of the Self Service interface, an administrator also enables end user access to Self Service.

The items below provide an overview of this administration and configuration.

27.2. Self Service Feature Display Policy

The Self Service Feature Display Policy is used by an administrator to determine which features or services are available to the Self Service User on the Self Service Interface. These are typically available on both the Button Bar and Dashboard.

Important: The configuration templates that are selected on the **Phones**, **Personal Phones** tabs may not contain macro values for Line Settings (nested Line Array fields), since these are not supported in VOSS-4-UC Self-service.

On the **Phones**, **Personal Phones** and **Voicemail** tabs, there are two similar check boxes (one associated with entitlement, the other not). For example, on the **Voicemail** tab, the first check box is labelled **User can enable Voicemail (Add a Voicemail Account)** and the second check box is labelled **User can enable Voicemail only if the user is entitled to Voicemail**.

If the Entitlement Feature is used, that is an Entitlement Profile is associated to the subscriber on the **Entitlement Profile** drop-down on the **Subscriber Management > Subscribers** screen, then select the second check box. If an Entitlement Profile is not associated to the subscriber, then select the first check box, as the second check box is no longer applicable.

In a similar way, select the appropriate check boxes on the the **Phones** and **Personal Phones** tabs.

Availability of features/services is configured using the following tabs on the **Self Service Feature Display Policy** screen:

- **Details**

Shows/hides the **My Availability** and **Speed Dials/Busy Lamp Fields** areas and associated functionality. This controls the ability to add and manage speed dials and busy lamps.

The **Enable (CFWD Only) Minimal Mode** check box controls the user self-service user interface. If enabled, the user is presented with a minimal interface suitable for mobile devices with *only* the functionality to set call forwarding. For details on the minimal interface, refer to the topic on Minimal Mode in the Self-service Guide.

- **Phones**

Shows/hides the **Your Company Phones** area and associated functionality. This controls the ability to add smart devices, as well as to manage company phones and associated lines.

- **Personal Phones**

Shows/hides the complete **Your Personal Phones** area and associated functionality, or hides selected functionality only, such as setting up ring schedules or advanced timer options. Also controls the ability to enable own personal phone management (add remote destination profile).

- **My Information**

Shows/hides one or more of the **My Information**, **My Credentials**, and **Webex Self Service** areas and the associated functionality.

- **Voicemail**

Shows/hides one or more of the **Voicemail Settings**, **Alternate Numbers and Notification Devices**, and **Caller Input** areas, as well as the associated functionality. Also controls the ability to add own Voicemail account if required.

- **Call Forward**

Shows/hides the complete **Call Forwarding** area and associated functionality, or selected advanced call forwarding functionality only, such forward calls to settings.

See [Self Service Feature Display Policy Field Reference](#) for field descriptions.

See also topics under:

- “Entitlement Management” - for more details about the Entitlement feature.
- “General Subscriber Management Tasks” - for more details about associating an Entitlement Profile to a subscriber.

27.3. Self Service Feature Display Policy Field Reference

Title	Field Name	Description
Details	details	Configure Base features.
Name*	name	The name of the Feature Group.
My Availability	my_availability	Turn my availability on/off.
Automatically update Presence Status from calendar	update_presence_from_calendar	Allow users to manage the setting that automatically updates their presence status based on their calendar. The user must have ‘IM and Presence’ enabled, and Self Service ‘My Availability’ settings must be in ‘Show’ state.
Speed Dials	speed_dials	Turn speed dials on/off.
FMC (Fixed Mobile Convergence)	fmc	Turn FMC on/off
CLI (Calling Line Identification)	cli	Turn CLI on/off
Enable (CFWD Only) Minimal Mode	enable_minimal_mode	Display Call Forward settings only minimal mode.

Title	Field Name	Description
Phones	phones	Configure Phone features.
User can add own smart devices	own_phone_add	User can add own smart devices. Default: false.
User can add own smart devices only if the user's Entitlement Profile includes 'Voice'	own_phone_add_if_entitled	Default : false.
Limit the user's total number of phones the number allowed by the user's Entitlement Profile	own_phone_add_limit_entitlement	Default : false.
Device Configuration Templates for User Phone Add	device_type_list.[n]	See below.
Phone Management	phone_management	Turn phone management on/off.
Phone Line Management	phone_line_management	Turn phone line management on/off.

Device Configuration Templates for User Phone Add	device_type_list.[n]	Smart Device configuration.
Device Name	devicetype	Choose from the drop-down list; either: iPhone, iPad, or Android Phone or Tablet.
Device Name Prefix	device_name_prefix	Automatically populated depending on the device name selected above; either TCT, TAB, or BOT.
Configuration Template	config_template	Select from the drop-down list. We recommend that you select the default configuration template for each device.

Title	Field Name	Description
Personal Phones	personal_phones	Configure Personal Phone features.
User can enable Personal Phone Management (add Remote Destination Profile)	user_add_rdp	Default: false
User can enable Personal Phone Management / SNR only if entitled to SNR	user_add_rdp_if_entitled	Default: false
Device Configuration Template for End User Remote Destination Profile Add	rdp_config_template	Choose from the drop-down list. Default = Default CUCM RDP Template.
Personal Phone Management	personal_phone_management	Turn personal phone management on/off.
Mobile Id Management	mobileid_management	Turn mobile id management on/off.
Ring Schedules	ring_schedules	Turn ring schedules on/off.
Advanced Timer Options	advanced_timer_options	Turn advanced timer options on/off.
Line Association	line_association	Turn line association on/off.

Title	Field Name	Description
My Information	my_information	Configure My Information features.
User Data	user_data	Turn user data on/off.
User Language	user_language	Turn user language on/off.
Password	password	Turn password on/off.
Pin	pin	Turn pin on/off.
Minimum Pin Length	pin_min_length	Minimum length of Pin (0 to 64 characters).
Link to Webex self service portal	webex_link	Toggle whether end user portal users can see a link to their Webex self service portal. The user must have an associated webex account in order to have the link.

Title	Field Name	Description
Voicemail	voicemail	Configure Voicemail features.
User can enable Voicemail (Add a Voicemail Account)	user_add_vm_account	Default: false
User can enable Voicemail only if the user is entitled to Voicemail	user_add_vm_account_if _entitled	Default: false
Device Configuration Template for End User Voicemail Account Add	voicemail_config_template	Choose from the drop-down list. Default = Default CUC User Template.
Voicemail Basic	voicemail_basic	Turn basic Voicemail on/off.
Voicemail Devices	voicemail_devices	Turn Voicemail devices on/off.
Phone Notification Device	phone_notification_device	Show/Hide Phone Notification Device management from end user.
SMS Notification Device	sms_notification_device	Show/Hide SMS Notification Device management from end user.
Voicemail Alternate Extensions	alternate_extensions	Show/Hide Voice Mail Alternate Extension management from end user.
Configuration Template for end user Alternate Extensions for Voicemail	cucalttext_config_template	Choose from the drop-down list. Default = cucalt-cft.
Configuration Template for end user add Phone Notification Devices	cucphonedevice_config_template	Choose from the drop-down list. Default = cucphone-cft.
Configuration Template for end user add SMS Notification Devices	cucsmsdevice_config_template	Choose from the drop-down list. Default = cucsms-cft.
Voicemail Caller Input	voicemail_callerinput	Turn Voicemail caller input on/off.
Voicemail Email Relay	voicemail_email_relay	Show/Hide Email Relay from end user.

Title	Field Name	Description
Call Forward	call_forward	Configure Call Forward features.
Call Forward Basic	call_fwd_basic	Turn basic call forwarding on/off.
Advanced Call Forward	call_fwd_adv	Turn advanced call forwarding on/off.

27.4. End User Access and Authentication

A user can log into the Self-Service GUI if a System User entry exists for the user. A System User entry is created automatically when a user is added as a subscriber. Refer to the topics under “Subscriber Management”.

You can grant a user access to Self-Service by creating a user, with a **Self-Service** role, directly in the System user interface. Such a user is not able to view devices or any services associated with the devices, nor can a manually added user view personal information such as first name, last name, address, department, and so on. Refer to [Add an Admin User](#).

Self-Service authentication is controlled by the administration interface using the same three authentication methods: Standard, LDAP, and SSO.

Consolidated password and PIN management for end users is available as follows, based on the self-service authentication method configured for the end user:

- Standard VOSS-4-UC authentication: end users can change their password and PIN from the Self Service interface.
- LDAP and SSO authentication: end users cannot change their password and PIN from the Self Service interface.

To ensure the best user experience, it is recommended that all applications (Self-Service and the Unified Communications applications) use the same authentication method.

27.5. Themes and Branding

The Self Service GUI interface can be branded by configuring Cascading Style Sheets, images and logos. The same theme upload and download interface used for the Admin Portal is used.

The theme itself differs between the Admin Portal and the Self Service interface (based on the user role).

The login page theme is also loaded from the URL:

```
https://<host>/selfservice/#/login?theme=<mytheme>
```

Refer to the topic “Download and Update a Theme”.

27.6. Self-Service Login Banner

The Self-Service login banner corresponds with the administrator interface banner.

For details on banner configuration and specifications, refer to the topic on “Login Banner” in the “Advanced Configuration Guide”.

27.7. Personal Phones (Remote Destinations)

You must allocate a remote destination profile (RDP) to end users for them to manage their own personal phones and simultaneous ring settings.

If no RDP is associated to the end user, the Personal Phones management interface in the Self Service application is hidden.

Multiple RDP's per end user is not supported. The Personal Phones management interface in Self Service is also hidden if an end user has more than one RDP associated. Refer to the topics under "Subscriber Workflows".

27.8. Dual Mode Phones - Mobile ID

If users have a dual mode device associated, they can manage the phone number and simultaneous ring settings for the device.

If no dual mode device is associated, the relevant settings are hidden in the Self Service interface. Refer to the "Subscriber Workflows" topic.

27.9. Voicemail for Self-Service

Voicemail settings are only visible in the Self Service interface if the user has a Voicemail box. Refer to the "Subscriber Workflows" topic.

27.10. Links Page

The contents of a user's Links page in the Self Service interface can be managed.

You can create one or more links to for example, Voicemail, WebEx, or downloadable content such as a User Guide.

Links on the page are associated to a user role and are managed using the Administration GUI Self Service Links interface.

Refer to "Create a Self Service Link".

28. Self Provisioning

28.1. Self-Provisioning Overview

The Cisco Unified Communications Manager Self-Provisioning feature allows an end user or administrator to add an unprovisioned phone to a Cisco Unified Communications Manager system with minimal administrative effort. A phone can be added by plugging it into the network and following a few prompts to identify the user.

The following process is used to self-provision a phone:

1. The user or admin connects the phone to the network.
2. The phone auto-registers.
3. The user or admin dials the IVR application and satisfies the prompts.
4. The IVR application deletes the auto-registered phone and adds it back using templates associated with the user via their User Profile.

There are two requirements related to self-provisioning:

1. Before a phone can be self-provisioned, the user must exist in Cisco Unified Communications Manager along with their primary extension, self service ID, and user profile.
2. After the phone is self-provisioned, in order to do additional subscriber management for the user in VOSS-4-UC, the user, line, and phone must be at the site level in the VOSS-4-UC hierarchy.

28.2. Bottom-Up User Management

A bottom-up approach to user management means users are configured on Cisco Unified Communications Manager (Unified CM) and synced into VOSS-4-UC. Two possible methods for bottom-up user management are:

- Sync LDAP directory into Unified CM. Do not configure the LDAP directory sync in Unified CM to use a line mask or DN pool to create the user's primary extension. Instead, the user's primary extension and self-service ID are generated in VOSS-4-UC, using a line mask, universal line template, and self-provisioning user profile at the site level.

Note:

During LDAP sync to Unified CM, the user is assigned a User Profile via the Feature Group Template associated with the LDAP directory. In order for the line mask configured at the site on VOSS-4-UC to get applied, the User Profile assigned previously must be empty or it must be named the 'Standard (Factory Default) User Profile'.

- Use Unified CM Quick User/Phone Add to create a user and the user's primary extension.

28.3. Top-Down User Management

A top-down approach to user management means users and lines are configured on VOSS-4-UC and pushed into Cisco Unified Communications Manager (Unified CM). Users may be added via LDAP sync, the Admin Portal, or bulk loading. When users are pushed to Unified CM the user's primary extension is created, and when a phone is self-provisioned for the user, the phone is automatically moved to the user's Site.

Use either of the following methods to configure the user in VOSS-4-UC:

- Generate the user's primary line and self-service ID using a line mask, universal line template, and a user profile at the site level.
- Set the self-service ID per user using Quick Add Subscriber.

Note: You can associate multiple devices (Jabber, iPhone, iPad, 78xx series IP phones, and 88xx series IP phones) to a single subscriber through VOSS-4-UC (Subscriber Management > Subscribers). This cannot be done through Quick Add Subscriber (QAS) as the default 9971 is added through QAS.

Using a combination of the methods above is possible but is not recommended. For example, you can enable the line mask at the site and use Quick Add Subscriber to set the primary line for some users while not setting it for others. When the line mask is applied, it first checks to see if a primary extension is already assigned to the user (perhaps via Quick Add Subscriber). If a primary extension is already assigned, the line mask is not applied.

28.4. Cisco Unified Communications Manager Configuration for Self-Provisioning

To use self-provisioning, regardless of whether top-down or bottom-up user management is used, you must complete these one-time configuration tasks on Cisco Unified Communications Manager:

- Ensure that the Cisco CallManager, Cisco CTIManager, and Self-Provisioning IVR services are activated
- Configure Auto Registration
- Create one partition and calling search space unique for self-provisioning
- Configure an Application User and credentials so the system can connect to the IVR self-provisioning service
- Configure a CTI Route Point (provides the number that users dial to connect to the IVR)
- Configure Self-Provisioning with the Application User and CTI Route Point

Refer to the Cisco Unified Communications Manager documentation for details.

28.5. Site Configuration for Self-Provisioning

Regardless of whether top-down or bottom-up user management is used, ensure that the following items have been configured in VOSS-4-UC:

- Site Defaults: **Site Management > Defaults**
- Internal Number Inventory: **Internal Number Inventory Management > Internal Number Inventory**

28.6. Generate a User's Primary Line

For top-down management, the system creates the user's primary line, associates the line as the primary extension, sets the self-service ID, and sets the user's profile. These activities occur when users are pushed to Cisco Unified Communications Manager.

For bottom-up management, the user's primary line is created (if necessary) when the user is moved to a site, or updated once at a site.

You create the line when you perform these tasks.

- Apply the line mask to a user attribute (typically the user's phone number).
- Use the Universal Line Template (ULT) to determine the route partition name and other line attributes. The ULT is specified in the Self-Provisioning User Profile, which is specified in the Site's Default User Profile.

For this approach, the administrator configures these items at the site level.

Perform these steps:

1. Configure Universal Device Templates. See [Add a Self-Provisioning Universal Device Template](#).
2. Configure Universal Line Templates. See [Add a Self-Provisioning Universal Line Template](#).
3. Configure Self-Provisioning User Profiles. See [Add a Self-Provisioning User Profile](#).
4. Configure a Site Default User Profile. See [Set a Default User Profile for a Site](#).
5. Configure the Line Mask. See [Add Self-Provisioning Line Mask](#).

28.7. Specify the Primary Line per Subscriber

In the top-down method that uses Quick Add Subscriber, the primary line pattern is specified by the admin. This creates the user's primary line, associates it as the primary extension, sets the self-service ID, and sets the user profile. The line attributes come from Quick Add Group configuration. Therefore, the Universal Line Template does not need to be configured.

Perform these steps:

1. Configure Universal Device Template(s). See [Add a Self-Provisioning Universal Device Template](#).
2. Configure Self-Provisioning User Profile(s). See [Add a Self-Provisioning User Profile](#).
3. Configure a Site Default User Profile. See [Set a Default User Profile for a Site](#).
4. Configure primary line per user.

For Quick Add Subscriber, add at least one line, and select the Self-Service ID check box.

28.8. Add a Self-Provisioning Universal Device Template

When the administrator or user self-provisions a phone, Cisco Unified Communications Manager deletes the autoregistered phone and adds the phone back into the database. The Universal Device Template (UDT) for the user's profile determines the various phone settings for the user's phone.

Perform these steps:

1. Log in as provider, reseller, or customer administrator.
2. Set the hierarchy path to the site node where you want to configure self-provisioning.
3. Choose **User Management > Self-Provisioning > Universal Device Template**.
4. Click **Add**.
5. Enter the following required UDT information.

Field	Description
Name	Enter the name of the UDT.
Location	Use locations to implement call admission control (CAC) in a centralized call-processing system. CAC regulates audio quality and video availability by limiting the amount of bandwidth for audio and video calls over links between locations. The location specifies the total bandwidth that is available for calls to and from this location.
Common Phone Profile	Choose a common phone profile.
Phone Personalization	Enable this setting to allow the UDT to work with Phone Designer, a Unified Communications widget. The widget lets a user customize the wallpaper and ringtones on a device.
Busy Trigger	This setting, which works with Maximum Number of Calls and Call Forward Busy, determines the maximum number of calls to be presented at the line. If the busy trigger is set to 40, incoming call 41 is rejected with a busy cause (and is forwarded if Call Forward Busy is set). If this line is shared, all the lines must be busy before incoming calls are rejected.
Max Number Of Calls	You can configure up to 200 calls for a line on a device. As you configure the number of calls for one line, the number calls that are available for another line decreases.
Multi-Level Precedence and Pre-emption	This setting specifies whether a device that can preempt calls in progress uses the capability when it places an MLPP precedence call.
Do Not Disturb Option	When you enable DND on the phone, this parameter allows you to specify how the DND features handle incoming calls.
Blf Presence Group	Enter the presence group applicable for busy lamp field buttons.
Device Mobility Mode	Turn the device mobility feature on or off for this device or choose Default to use the default device mobility mode. Default setting uses the value for the Device Mobility Mode service parameter for the device.

The following fields can be prepopulated, depending on customer, site, and dial plan configuration:

- Name
- Location
- Common Phone Profile
- BLF Presence Group

6. Enter the following optional, but highly recommended information. These fields can be prepopulated, depending on customer, site, and dial plan configuration.

Field	Description
Device Pool	Enter a site-specific device pool.
Owner User ID	The userid of the user associated with the phone. The recommended is Current Device Owner's User ID.

7. Enter other optional settings, if applicable.
8. Click **Save**.

28.9. Add a Self-Provisioning Universal Line Template

The Universal Line Template (ULT) is used before self-provisioning actually takes place. ULTs are used to create directory numbers on Cisco Unified Communications Manager. A directory number is identified by a pattern (the number portion) and a route partition. A directory number also has various settings that can be configured for the line. When a directory number is created using a ULT, the ULT determines the route partition and the line settings.

Perform these steps:

1. Log in as provider, reseller, or customer administrator.
2. Set the hierarchy path to the site node where you want to configure self-provisioning.
3. Choose **User Management > Self-Provisioning > Universal Line Template**.
4. Click **Add**.
5. Enter the following required Universal Line Template information.

Field	Description
Name	The name of the universal line template
Location	Use locations to implement call admission control (CAC) in a centralized call-processing system. CAC regulates audio quality and video availability by limiting the amount of bandwidth for audio and video calls over links between locations. The location specifies the total bandwidth that is available for calls to and from this location.
Partition	Enter the route partition used to create lines at the site.
Blf Presence Group	Enter the presence group applicable for busy lamp field buttons.

6. Enter other optional settings, if applicable.
7. Click **Save**.

28.10. Add a Self-Provisioning User Profile

Perform these steps:

1. Log in as provider, reseller, or customer administrator.
2. Set the hierarchy path to the site node where you want to configure self-provisioning.
3. Choose **User Management > Self-Provisioning > User Profile**.
4. Click **Add**.
5. Enter the user profile information.

Field	Description
Name	Enter the name of the user profile. This field is mandatory.
Universal Line Template	Enter a site-specific ULT. This field is highly recommended.

6. Click the **Device Template Desk Phone** tab.
 - a. Click '+' to add a new template.
 - b. From the **Device Security Profile** drop-down, choose **Model-independent Security Profile**.
 - c. From the **Sip Profile** drop-down, choose the required SIP Profile.
 - d. Select the **Allow Control of Device From Cti** check box.
 - e. From the **Calling Search Space** drop-down, choose the appropriate option, for example Cu2Si4-InternalOnly-CSS.
7. Click the **Line Template** tab.
 - a. Click '+' to add a new template.
 - b. From the **Partition** drop-down, choose the appropriate partition, for example Cu2-DirNum-PT.
 - c. From the **Calling Search Space** drop-down, choose the appropriate calling search space, for example Cu2Si4-InternalOnly-CSS.
 - d. From the **Voice Mail Profile** drop-down, choose the appropriate option, for example Default.
8. Click **Save**.
9. Enter other optional settings, if applicable.

Next Steps

Set a Default User Profile for a Site.

28.11. Set a Default User Profile for a Site

Set a default user profile for a site, to be used when no user profile is specified when adding a subscriber.

Perform these steps:

1. Choose **Site Management > Defaults**.
2. Click the user profile to set as the default.
3. On the **General Defaults** tab, and from the **Default User Profile (for User Self Provisioning)** dropdown, choose the default user profile for the site.
4. Click **Save**.

28.12. Add Self-Provisioning Line Mask

Perform these steps:

1. Log in as provider, reseller, or customer administrator.
2. Set the hierarchy path to the site node where you want to configure self-provisioning.
3. Choose **User Management > Self-Provisioning > Line Mask** (default).
4. Click **Add**.
5. Provide the following information:

Field	Description
Description	A description of the Line Mask.
User Attribute*	Select the user attribute used to generate the user's primary extension. The default is 'telephoneNumber'. This field is mandatory.
Mask*	Provide a mask which gets applied to the user attribute. The result is used as the user's primary extension. For example, assume user attribute is telephoneNumber and the mask is 4XXXX. Special characters and blanks are stripped from the user attribute before applying the mask. If the mask is applied to '(919) 867-5309', the user's primary extension would be set to 45309. This field is mandatory.

6. Click **Save**.

29. Advanced Tools for System Administrators

29.1. Custom Variables

29.1.1. Add Custom Variables

System administrators can create custom macros for use in for example custom Configuration Templates.

Note:

- The macro needs to be evaluated at the hierarchy that it is created.
 - The same macro variable can be defined to have different values at different hierarchies.
-

1. Choose **Advanced Tools > Custom Variables** and click **Add**.
2. Enter the macro name, optional description and value. The name must be prefixed with `CV_`. For details on macro syntax, refer to the “Advanced Configuration Guide”.
3. Click **Save**.

To test the macro, enter it in the macro evaluator at **Administration Tools > Macro Evaluator**.

Example

Create:

```
CV_current_time  
Current time is: {{ fn.now }}
```

Invoke:

```
{{ macro.CV_current_time }}
```

Output example:

```
Current time is: 2017-03-31 13:20:18.509871
```

29.2. Model Report

29.2.1. Create Model Report

System and advanced administrators can create and display reports on the data under a selected site hierarchy. The purpose of such a report is to show the model types: device and data models at a site as well as the number of instances of each model type.

Reports for a hierarchy can be created, listed, viewed and deleted. Note that the relation data type is not shown, but component data models are reported on.

1. Log in as system administrator.
2. Navigate to the hierarchy for which the report is to be created.
3. Choose **Advanced Tools > Model Report > Create Model Report**
4. Verify that the Hierarchy level value is the required hierarchy.
5. Choose the model types to be reported on:
 - DATA Models
 - CUCM Models
 - CUC Models
 - LDAP Models
 - HCM-F Models (only if HCM-F is installed)
6. Click **Save** to create the report.

The time stamp of the report at the hierarchy is recorded. To see the progress of the report creation, choose **Advanced Tools > Model Report > Model Reports** and from the list of reports, either inspect the value in the **Status** column or choose the report to see the status. The report is available when the status is **Done**.

29.2.2. Manage Model Reports

Reports can be viewed and deleted.

1. Log in as system administrator.
2. Choose **Advanced Tools > Model Report > Model Reports**
3. To view a report, click the report to view. Details for each model type are displayed on a tab.
4. The **Detail** tab shows:
 - the type of report
 - date of creation
 - hierarchy of the report

The model tabs show Count value for each model type, if these were selected. If a model type has no instances, in other words a zero count, this is not shown.

5. To delete a report, choose the report and click **Delete**.

29.3. Menu Diff Tool

29.3.1. Menu Diff Tool

Note: This feature is available only in the VOSS-4-UC Admin Portal. It is not available in the Legacy Admin Portal.

System level (hcsadmin, entadmin) and provider administrators have access to the Menu Diff tool on the menu to allow for a side-by-side comparison and management of two selected menu layouts:

- **Source Menu:** a drop-down list of menu layouts from hierarchies at the administrator's hierarchy *and higher*.
- **Target Menu:** a drop-down list of menu layouts from hierarchies at the administrator's hierarchy *and lower*.

The side-by-side forms with the two selected menus can be expanded using the **Expand/Collapse** button.

Menu differences are highlighted as follows:

- The same menu item in both menus but on a different menu path is highlighted.
- A menu item in one menu but not in the other menu is highlighted.

To update the target menu, drag and drop menu items from the source menu to a position in the target menu.

- Where a menu item is now in both menus, it is not highlighted anymore.

Note:

- All menu properties (e.g. Field Display Policy, model reference, and so on) are copied.
 - If the menu item that is copied contains sub-menus, these are included.
-

Click **Save** to save changes in the target menu.

30. Appendix: Business Admin Portal Configuration

30.1. Business Admin Portal Configuration Overview

In VOSS-4-UC version 19.1.1 (or higher), a number of mechanisms are introduced to allow the Business Admin Portal (BAP) to be customized for different customers and even different roles within an organization.

The following aspects of the portal can be customized

- Role based access control (see: *Business Admin Portal Profiles*)
 - Access to features (menu items)
 - Access to MACDs / Day 2 functions
 - Access to dashboard widgets (charts etc.)
- Look and feel (see: *Custom Business Admin Themes and Branding*)
 - Branding / theming
 - Field visibility, order, title and help text
- Configuration Templates
 - Subscriber Profiles (service profiles) (see: *Subscriber Profiles*)
 - Available phone types with related configuration (see: *Phone Configuration Mapping*)
 - Line templates
- User level customization
 - Saved searches
 - UI user preferences

For all of the above, default profiles and templates have been created and will be added to the system during an upgrade to 19.1.1 (or higher).

In previous versions of VOSS-4-UC, BAP was disabled by default and needed to be enabled. In 19.1.1 (or higher) however, BAP will be enabled by default and must specifically be disabled if so required.





























































It is important that the defaults are reviewed and if required, be cloned (overridden) and amended to fit the requirements of the deployment.

30.2. Custom Icon Names Reference





























































This reference shows the icons associated with the **Icon** name drop-downs in the interface.

To associate the icon of the in the drop-down, inspect the titles below, remove the title hyphens and capitalize the first letter of each word. The section headings below show the first and last icon names in each section.





























































30.2.1. “3d Rotation” to “Assignment Return”

 3d-rotation	 ac-unit	 access-alarm	 access-alarms	 access-time	 accessibility
 accessible	 account-balance	 account-balance-wallet	 account-box	 account-circle	 add
 add-a-photo	 add-alarm	 add-alert	 add-box	 add-circle	 add-circle-outline
 add-location	 add-shopping-cart	 add-to-photos	 add-to-queue	 adjust	 airline-seat-flat
 airline-seat-flat-angled	 airline-seat-individual-suite	 airline-seat-legroom-extra	 airline-seat-legroom-normal	 airline-seat-legroom-reduced	 airline-seat-recline-extra
 airline-seat-recline-normal	 airplanemode-active	 airplanemode-inactive	 airplay	 airport-shuttle	 alarm
 alarm-add	 alarm-off	 alarm-on	 album	 all-inclusive	 all-out
 android	 announcement	 apps	 archive	 arrow-back	 arrow-downward
 arrow-drop-down	 arrow-drop-down-circle	 arrow-drop-up	 arrow-forward	 arrow-upward	 art-track
 aspect-ratio	 assessment	 assignment	 assignment-ind	 assignment-late	 assignment-return





























































30.2.2. “Assignment Returned” to “Bug Report”

 assignment-returned	 assignment-turned-in	 assistant	 assistant-photo	 attach-file	 attach-money
 attachment	 audiotrack	 autorenew	 av-timer	 backspace	 backup
 battery-alert	 battery-charging-full	 battery-full	 battery-std	 battery-unknown	 beach-access
 beenhere	 block	 bluetooth	 bluetooth-audio	 bluetooth-connected	 bluetooth-disabled
 bluetooth-searching	 blur-circular	 blur-linear	 blur-off	 blur-on	 book
 bookmark	 bookmark-border	 border-all	 border-bottom	 border-clear	 border-color
 border-horizontal	 border-inner	 border-left	 border-outer	 border-right	 border-style
 border-top	 border-vertical	 branding-watermark	 brightness-1	 brightness-2	 brightness-3
 brightness-4	 brightness-5	 brightness-6	 brightness-7	 brightness-auto	 brightness-high
 brightness-low	 brightness-medium	 broken-image	 brush	 bubble-chart	 bug-report

























































30.2.3. “Build” to “Colorize”

 build	 burst-mode	 business	 business-center	 cached	 cake
 call	 call-end	 call-made	 call-merge	 call-missed	 call-missed-outgoing
 call-received	 call-split	 call-to-action	 camera	 camera-alt	 camera-enhance
 camera-front	 camera-rear	 camera-roll	 cancel	 card-giftcard	 card-membership
 card-travel	 casino	 cast	 cast-connected	 center-focus-strong	 center-focus-weak
 change-history	 chat	 chat-bubble	 chat-bubble-outline	 check	 checkbox
 checkbox-outline-blank	 check-circle	 chevron-left	 chevron-right	 child-care	 child-friendly
 chrome-reader-mode	 class	 clear	 clear-all	 close	 closed-caption
 cloud	 cloud-circle	 cloud-done	 cloud-download	 cloud-off	 cloud-queue
 cloud-upload	 code	 collections	 collections-bookmark	 color-lens	 colorize



























































30.2.4. “Comment” to “Do Not Disturb”

 comment	 compare	 compare-arrows	 computer	 confirmation-number	 contact-mail
 contact-phone	 contacts	 content-copy	 content-cut	 content-paste	 control-point
 control-point-duplicate	 copyright	 create	 create-new-folder	 credit-card	 crop
 crop-16-9	 crop-3-2	 crop-5-4	 crop-7-5	 crop-din	 crop-free
 crop-landscape	 crop-original	 crop-portrait	 crop-rotate	 crop-square	 dashboard
 data-usage	 date-range	 dehaze	 delete	 delete-forever	 delete-sweep
 description	 desktop-mac	 desktop-windows	 details	 developer-board	 developer-mode
 device-hub	 devices	 devices-other	 dialer-sip	 dialpad	 directions
 directions-bike	 directions-boat	 directions-bus	 directions-car	 directions-railway	 directions-run
 directions-subway	 directions-transit	 directions-walk	 disc-full	 dns	 do-not-disturb



























































30.2.5. “Do Not Disturb Alt” to “Filter 4”

 do-not-disturb-alt	 do-not-disturb-off	 do-not-disturb-on	 dock	 domain	 done
 done-all	 donut-large	 donut-small	 drafts	 drag-handle	 drive-eta
 dvr	 edit	 edit-location	 eject	 email	 enhanced-encryption
 equalizer	 error	 error-outline	 euro-symbol	 ev-station	 event
 event-available	 event-busy	 event-note	 event-seat	 exit-to-app	 expand-less
 expand-more	 explicit	 explore	 exposure	 exposure-neg-1	 exposure-neg-2
 exposure-plus-1	 exposure-plus-2	 exposure-zero	 extension	 face	 fast-forward
 fast-rewind	 favorite	 favorite-border	 featured-play-list	 featured-video	 feedback
 fiber-dvr	 fiber-manual-record	 fiber-new	 fiber-pin	 fiber-smart-record	 file-download
 file-upload	 filter	 filter-1	 filter-2	 filter-3	 filter-4





























































30.2.6. “Filter 5” to “Forum”

 filter-5	 filter-6	 filter-7	 filter-8	 filter-9	 filter-9-plus
 filter-b-and-w	 filter-center-focus	 filter-drama	 filter-frames	 filter-hdr	 filter-list
 filter-none	 filter-tilt-shift	 filter-vintage	 find-in-page	 find-replace	 fingerprint
 first-page	 fitness-center	 flag	 flare	 flash-auto	 flash-off
 flash-on	 flight	 flight-land	 flight-takeoff	 flip	 flip-to-back
 flip-to-front	 folder	 folder-open	 folder-shared	 folder-special	 font-download
 format-align-center	 format-align-justify	 format-align-left	 format-align-right	 format-bold	 format-clear
 format-color-fill	 format-color-reset	 format-color-text	 format-indent-decrease	 format-indent-increase	 format-italic
 format-line-spacing	 format-list-bulleted	 format-list-numbered	 format-paint	 format-quote	 format-shapes
 format-size	 format-strikethrough	 format-textdirection-l-to-r	 format-textdirection-r-to-l	 format-underlined	 forum





























































30.2.7. “Forward” to “Input”

 forward	 forward-10	 forward-30	 forward-5	 free-breakfast	 fullscreen
 fullscreen-exit	 functions	 g-translate	 gamepad	 games	 gavel
 gesture	 get-app	 gif	 golf-course	 gps-fixed	 gps-not-fixed
 gps-off	 grade	 gradient	 grain	 graphic-eq	 grid-off
 grid-on	 group	 group-add	 group-work	 hd	 hdr-off
 hdr-on	 hdr-strong	 hdr-weak	 headset	 headset-mic	 healing
 hearing	 help	 help-outline	 high-quality	 highlight	 highlight-off
 history	 home	 hot-tub	 hotel	 hourglass-empty	 hourglass-full
 http	 https	 image	 image-aspect-ratio	 import-contacts	 import-export
 important-devices	 inbox	 indeterminate-check-box	 info	 info-outline	 input



































30.2.8. “Insert Chart” to “Local gas Station”

 insert-chart	 insert-comment	 insert-drive-file	 insert-emoticon	 insert-invitation	 insert-link
 insert-photo	 invert-colors	 invert-colors-off	 iso	 keyboard	 keyboard-arrow-down
 keyboard-arrow-left	 keyboard-arrow-right	 keyboard-arrow-up	 keyboard-backspace	 keyboard-capslock	 keyboard-hide
 keyboard-return	 keyboard-tab	 keyboard-voice	 kitchen	 label	 label-outline
 landscape	 language	 laptop	 laptop-chromebook	 laptop-mac	 laptop-windows
 last-page	 launch	 layers	 layers-clear	 leak-add	 leak-remove
 lens	 library-add	 library-books	 library-music	 lightbulb-outline	 line-style
 line-weight	 linear-scale	 link	 linked-camera	 list	 live-help
 live-tv	 local-activity	 local-airport	 local-atm	 local-bar	 local-cafe
 local-car-wash	 local-convenience-store	 local-dining	 local-drink	 local-florist	 local-gas-station









































30.2.9. “Local Grocery Store” to “More Vert”

 local-grocery-store	 local-hospital	 local-hotel	 local-laundry-service	 local-library	 local-mall
 local-movies	 local-offer	 local-parking	 local-pharmacy	 local-phone	 local-pizza
 local-play	 local-post-office	 local-printshop	 local-see	 local-shipping	 local-taxi
 location-city	 location-disabled	 location-off	 location-on	 location-searching	 lock
 lock-open	 lock-outline	 looks	 looks-3	 looks-4	 looks-5
 looks-6	 looks-one	 looks-two	 loop	 loupe	 low-priority
 loyalty	 mail	 mail-outline	 map	 markunread	 markunread-mailbox
 memory	 menu	 merge-type	 message	 mic	 mic-none
 mic-off	 mms	 mode-comment	 mode-edit	 monetization-on	 money-off
 monochrome-photos	 mood	 mood-bad	 more	 more-horiz	 more-vert





























































30.2.10. “Motorcycle” to “Perm Identity”

 motorcycle	 mouse	 move-to-inbox	 movie	 movie-creation	 movie-filter
 multiline-chart	 music-note	 music-video	 my-location	 nature	 nature-people
 navigate-before	 navigate-next	 navigation	 near-me	 network-cell	 network-check
 network-locked	 network-wifi	 new-releases	 next-week	 nfc	 no-encryption
 no-sim	 not-interested	 note	 note-add	 notifications	 notifications-active
 notifications-none	 notifications-off	 notifications-paused	 offline-pin	 ondemand-video	 opacity
 open-in-browser	 open-in-new	 open-with	 pages	 pageview	 palette
 pan-tool	 panorama	 panorama-fish-eye	 panorama-horizontal	 panorama-vertical	 panorama-wide-angle
 party-mode	 pause	 pause-circle-filled	 pause-circle-outline	 payment	 people
 people-outline	 perm-camera-mic	 perm-contact-calendar	 perm-data-setting	 perm-device-information	 perm-identity























































30.2.11. “Perm Media” to “Priority High”

 perm-media	 perm-phone-msg	 perm-scan-wifi	 person	 person-add	 person-outline
 person-pin	 person-pin-circle	 personal-video	 pets	 phone	 phone-android
 phone-bluetooth-speaker	 phone-forwarded	 phone-in-talk	 phone-iphone	 phone-locked	 phone-missed
 phone-paused	 phonelink	 phonelink-erase	 phonelink-lock	 phonelink-off	 phonelink-ring
 phonelink-setup	 photo	 photo-album	 photo-camera	 photo-filter	 photo-library
 photo-size-select-actual	 photo-size-select-large	 photo-size-select-small	 picture-as-pdf	 picture-in-picture	 picture-in-picture-alt
 pie-chart	 pie-chart-outlined	 pin-drop	 place	 play-arrow	 play-circle-filled
 play-circle-outline	 play-for-work	 playlist-add	 playlist-add-check	 playlist-play	 plus-one
 poll	 polymer	 pool	 portable-wifi-off	 portrait	 power
 power-input	 power-settings-new	 pregnant-woman	 present-to-all	 print	 priority-high





























































30.2.12. “Public” to “Sd Card”

 public	 publish	 query-builder	 question-answer	 queue	 queue-music
 queue-play-next	 radio	 radio-button-checked	 radio-button-unchecked	 rate-review	 receipt
 recent-actors	 record-voice-over	 redeem	 redo	 refresh	 remove
 remove-circle	 remove-circle-outline	 remove-from-queue	 remove-red-eye	 remove-shopping-cart	 reorder
 repeat	 repeat-one	 replay	 replay-10	 replay-30	 replay-5
 reply	 reply-all	 report	 report-problem	 restaurant	 restaurant-menu
 restore	 restore-page	 ring-volume	 room	 room-service	 rotate-90-degrees-ccw
 rotate-left	 rotate-right	 rounded-corner	 router	 rowing	 rss-feed
 rv-hookup	 satellite	 save	 scanner	 schedule	 school
 screen-lock-landscape	 screen-lock-portrait	 screen-lock-rotation	 screen-rotation	 screen-share	 sd-card















































30.2.13. “Sd Storage” to “Sms”

 sd-storage	 search	 security	 select-all	 send	 sentiment-dissatisfied
 sentiment-neutral	 sentiment-satisfied	 sentiment-very-dissatisfied	 sentiment-very-satisfied	 settings	 settings-applications
 settings-backup-restore	 settings-bluetooth	 settings-brightness	 settings-cell	 settings-ethernet	 settings-input-antenna
 settings-input-component	 settings-input-composite	 settings-input-hdmi	 settings-input-svideo	 settings-overscan	 settings-phone
 settings-power	 settings-remote	 settings-system-daydream	 settings-voice	 share	 shop
 shop-two	 shopping-basket	 shopping-cart	 short-text	 show-chart	 shuffle
 signal-cellular-4-bar	 signal-cellular-connected-no-internet-4-bar	 signal-cellular-no-sim	 signal-cellular-null	 signal-cellular-off	 signal-wifi-4-bar
 signal-wifi-4-bar-lock	 signal-wifi-off	 sim-card	 sim-card-alert	 skip-next	 skip-previous
 slideshow	 slow-motion-video	 smartphone	 smoke-free	 smoking-rooms	 sms





































30.2.14. “Sms Failed” to “Texture”

 sms-failed	 snooze	 sort	 sort-by-alpha	 spa	 space-bar
 speaker	 speaker-group	 speaker-notes	 speaker-notes-off	 speaker-phone	 spellcheck
 star	 star-border	 star-half	 stars	 stay-current-landscape	 stay-current-portrait
 stay-primary-landscape	 stay-primary-portrait	 stop	 stop-screen-share	 storage	 store
 store-mall-directory	 straighten	 streetview	 strikethrough-s	 style	 subdirectory-arrow-left
 subdirectory-arrow-right	 subject	 subscriptions	 subtitles	 subway	 supervisor-account
 surround-sound	 swap-calls	 swap-horiz	 swap-vert	 swap-vertical-circle	 switch-camera
 switch-video	 sync	 sync-disabled	 sync-problem	 system-update	 system-update-alt
 tab	 tab-unselected	 tablet	 tablet-android	 tablet-mac	 tag-faces
 tap-and-play	 terrain	 text-fields	 text-format	 textsms	 texture

30.2.15. “Theaters” to “View Quilt”

 theaters	 thumb-down	 thumb-up	 thumbs-up-down	 time-to-leave	 timelapse
 timeline	 timer	 10s timer-10	 3s timer-3	 timer-off	 title
 toc	 today	 toll	 tonality	 touch-app	 toys
 track-changes	 traffic	 train	 tram	 transfer-within-a-station	 transform
 translate	 trending-down	 trending-flat	 trending-up	 tune	 turned-in
 turned-in-not	 tv	 unarchive	 undo	 unfold-less	 unfold-more
 update	 usb	 verified-user	 vertical-align-bottom	 vertical-align-center	 vertical-align-top
 vibration	 video-call	 video-label	 video-library	 videocam	 videocam-off
 videogame-asset	 view-agenda	 view-array	 view-carousel	 view-column	 view-comfy
 view-compact	 view-day	 view-headline	 view-list	 view-module	 view-quilt

30.2.16. “View Stream” to “Zoom Out Map”

 view-stream	 view-week	 vignette	 visibility	 visibility-off	 voice-chat
 voicemail	 volume-down	 volume-mute	 volume-off	 volume-up	 vpn-key
 vpn-lock	 wallpaper	 warning	 watch	 watch-later	 wb-auto
 wb-cloudy	 wb-incandescent	 wb-iridescent	 wb-sunny	 wc	 web
 web-asset	 weekend	 whatshot	 widgets	 wifi	 wifi-lock
 wifi-tethering	 work	 wrap-text	 youtube-searched-for	 zoom-in	 zoom-out
 zoom-out-map					

30.3. Custom Business Admin Themes and Branding

It is possible to create a custom theme which changes the following properties of the Business Admin Portal:

- Primary and accent colors
- Logo image
- Login screen background image
- Background image for menu
- Browser tab title

See “Create a Theme in the Business Admin Portal” in the Core Feature Guide for details.

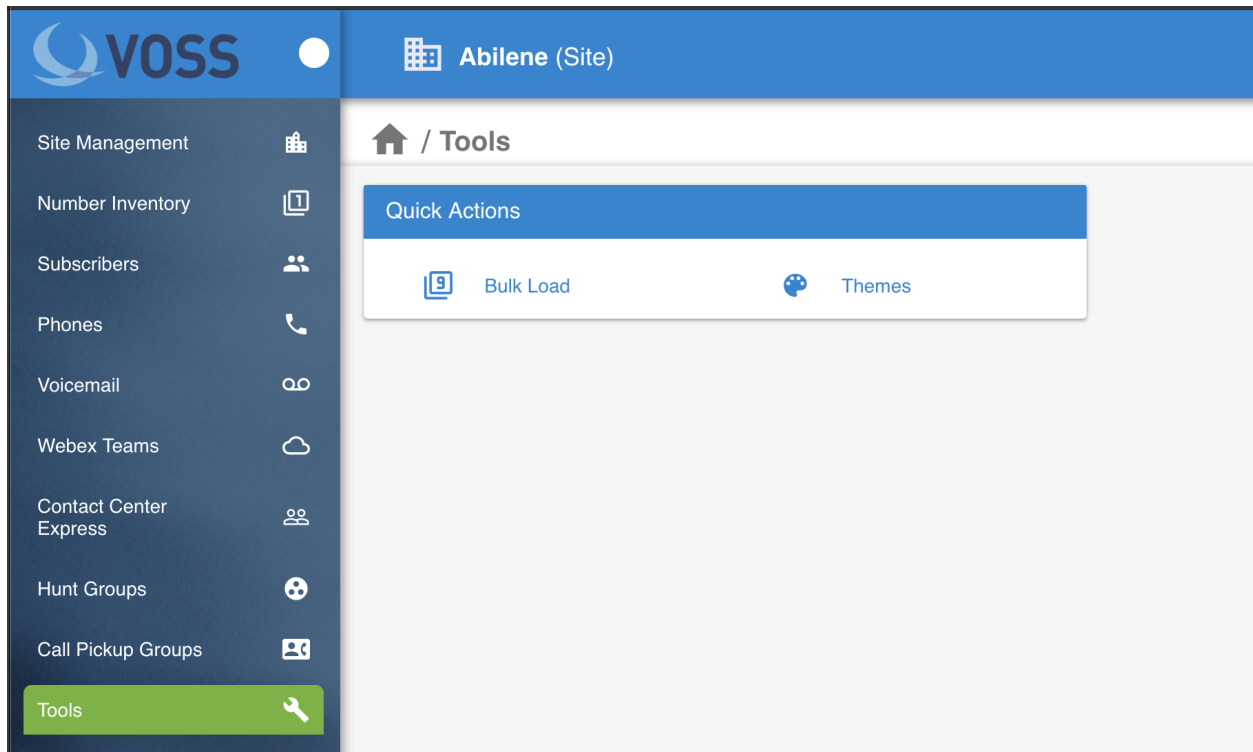

30.4. Theme Management

30.4.1. Create a Theme in the Admin and Business Admin Portal

The **Themes** interface in the Admin and Business Admin Portal can be used to create a theme that applies to the Business Admin Portal as well as the VOSS-4-UC Admin Portal.

Note:

- Since two themes are compiled when saving a new theme on the Business Admin Portal, this takes slightly longer than theme compilation on the VOSS-4-UC Admin Portal.
- Themes created in the Admin Portal and Business Admin Portal:
 - cannot be exported in full
 - require the use of the Legacy Admin Portal to include login page text and to define a non-admin Interface.

Use the **Preview** button to preview the saved theme before it is applied to the user interface by assigning it to a user role.

Theme Details

Note: If the Admin Portal or Business Admin Portal Theme interface is to be used for full Admin Portal theme configuration, a Custom Admin Portal File should be uploaded.

- **Custom Admin Portal File:**
 - If a *theme file is added*:

the theme file will apply the Legacy Admin Portal, while the theme customization updates made in the **Branding** group of controls will *only* apply to the Admin Portal and Business Admin Portal, but may be overridden in the Legacy Admin Portal.

- If *no theme file is added*:

the theme updates made in the **Branding** group of controls are applied to Legacy Admin Portal, Admin Portal and the Business Admin Portal. The **Custom Admin Portal File** upload control is then *not* available for theme modification.

Branding

Note: Color selection is optional: where no colors are selected, defaults apply.

- Color selection:
 - Select a color using either the color picker control or by typing in the color hex value. The color picker control is only available on the Business Admin Portal theme interface.Refer to:
 - * [Legacy Admin Portal Theme Element Color Reference](#).
 - * [Administration Portal Theme Customization Color Reference](#)
- Image upload:
 - Note the file size and *width x height* pixel dimension size restrictions (shown on the context sensitive help) for images. A warning message will also show if selected images are too large.The **Logo** image format must be PNG format. Other images can be PNG or JPEG.
 - The **Menu Background** image does not apply to the VOSS-4-UC Admin Portal.

30.4.2. Legacy Admin Portal Theme Element Color Reference

Note: Color selection is optional: where no colors are selected, defaults apply.

The Legacy Admin Portal GUI Element variable below is a descriptive name of the Admin Portal and Business Admin Portal GUI element that will be affected by the Color variable, which corresponds with the color name on the Theme design form.

Element	Color	Theme GUI Branding tab
\$sidebarLogoBgColor	\$primaryColor	Primary Color
\$sidebarBgColor	\$primaryColor	Primary Color
\$topbarTextColor	\$primaryLightestColor	Very Light Primary Colour
\$topbarIconColor	\$primaryLightestColor	Very Light Primary Colour
\$submenuBgColor	\$primaryColor	Primary Color
\$darkSubmenuBgColor	\$primaryDarkColor	Dark Primary Colour
\$horizontalSubmenuBgColor	\$primaryColor	Primary Color
\$horizontalSubmenuItemHoverBgColor	\$primaryColor	Primary Color
\$horizontalSubmenuItemDarkHoverBgColor	\$primaryColor	Primary Color
\$menuItemActiveBgColor	\$accentColor	Accent Color
\$subMenuItemActiveTextColor	\$accentLightColor	Light Accent Color
\$subMenuItemActiveIconTextColor	\$accentLightColor	Light Accent Color
\$darkMenuItemActiveBgColor	\$accentColor	Accent Color
\$darksubMenuItemActiveTextColor	\$accentLightColor	Light Accent Color
\$darksubMenuItemActiveIconTextColor	\$accentLightColor	Light Accent Color

30.4.3. Administration Portal Theme Customization Color Reference

Note:

- Color selection on the **Branding** tab of a theme *always* affects the Admin and Business Admin Portal.
- Color selection on the **Branding** tab of a theme *only* affects the Legacy Admin Portal *if no theme file* is attached to the theme.

To edit and manage theme files:







Refer to Less files and Theme Customization in the Advanced Configuration Guide.

- Color selection is optional: where no colors are selected, defaults apply.

On the Legacy Admin Portal, consider the color selection on the **Theme Customisation** tab:

Primary Colour	#6aa103
Dark Primary Colour	#3c00ff
Light Primary Colour	#00e6ff
Very Light Primary Colour	#c4ff00
Accent Colour	#f7ff00
Light Accent Colour	#ff00bb

On the Admin Portal, consider the color selection on the **Branding** tab:

Primary Colour	#6aa103	
Dark Primary Colour	#3c00ff	
Light Primary Colour	#00e6ff	
Very Light Primary Colour	#c4ff00	
Accent Colour	#f7ff00	
Light Accent Colour	#ff00bb	

The screens below show how the branding colors of the theme appear in the Legacy, current and Business Admin Portal.

Legacy Admin Portal

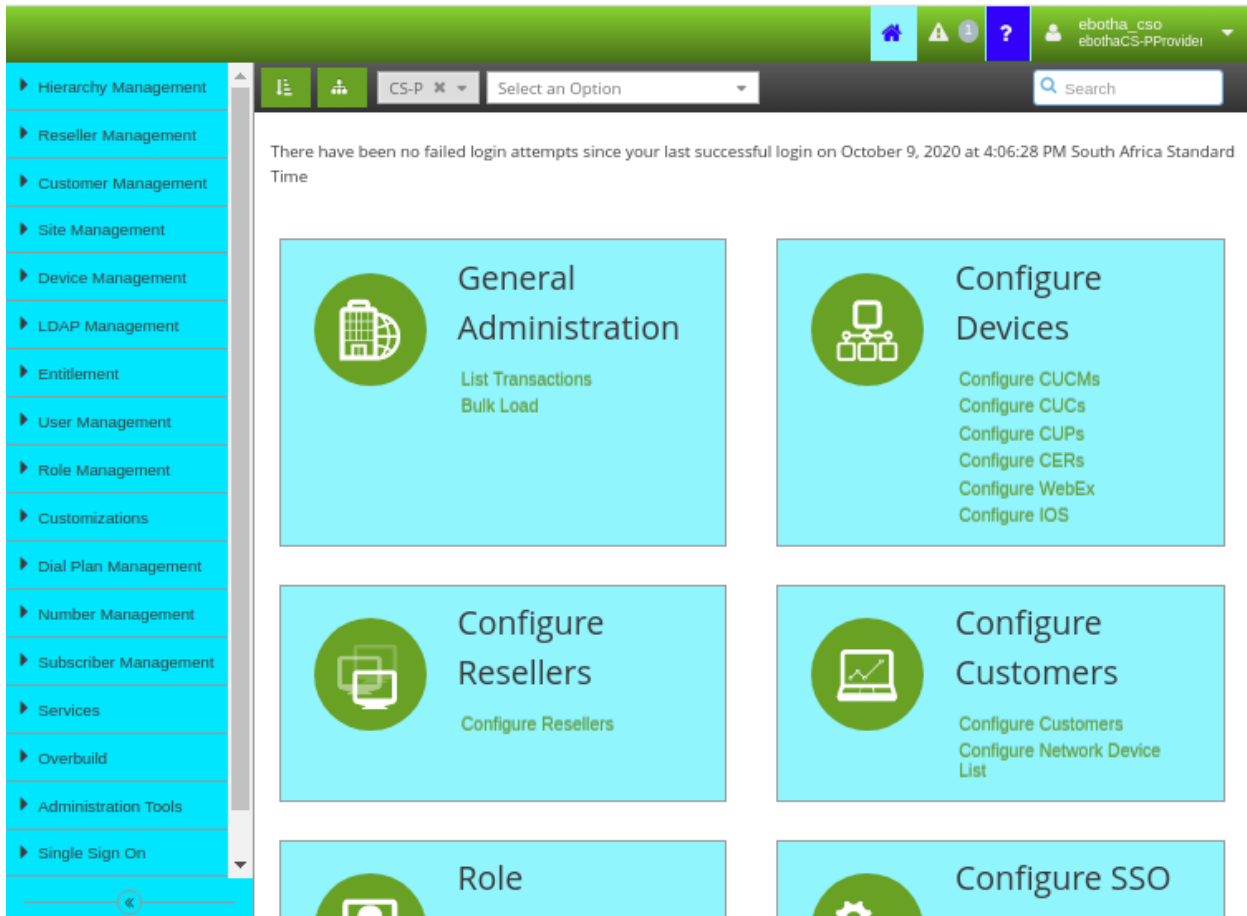

The screenshot displays the Legacy Admin Portal interface. The top navigation bar is green, and the left sidebar is blue. The main content area is white with a grid of blue tiles. The tiles are labeled: General Administration, Configure Devices, Configure Resellers, Configure Customers, Role, and Configure SSO. The interface uses the branding colors defined in the table above.

Name	Description	Target Model Type	Located At
AddCustomerAdmin_FDP		data/User	sys (System)
AddSubscriberWizard_AdvD...	FDP for Extension Mobility step in Subscriber ...	device/cucm/DeviceProfile	sys (System)
AddSubscriberWizard_AdvLi...	FDP for Advanced Line settings in Subscriber W...	device/cucm/Line	sys (System)
AddSubscriberWizard_AdvP...	FDP for Advanced Phone settings in Subscriber...	device/cucm/Phone	sys (System)
AddSubscriberWizard_AdvP...	FDP for Advanced Phone settings in Subscriber...	relation/SubscriberPhone	sys (System)
AddSubscriberWizard_AdvR...	FDP for SNR (Destination) step in Subscriber Wi...	device/cucm/RemoteDestination	sys (System)
AddSubscriberWizard_AdvR...	FDP for SNR (Profile) step in Subscriber Wizard	device/cucm/RemoteDestinationP...	sys (System)
AddSubscriberWizard_AdvU...	FDP for Advanced User settings in Subscriber ...	device/cucm/User	sys (System)
AddSubscriberWizard_Wizar...	FDP for Setup step in Subscriber Wizard	view/AddSubscriberWizard_Wizard...	sys (System)
AdminUser		relation/User	sys (System)

Field Display Policies [AddSubscriberWizard_AdvPhoneRel_FDP]

Name*: AddSubscriberWizard_AdvPhoneRel_FDP

Description: FDP for Advanced Phone settings in Subscriber Wizard using relation/Phone

Target Model Type*: relation/SubscriberPhone

Groups *

Title*: Advanced Settings

Display as Fieldset:

Number of Columns:

Available	Selected
aarNeighborhoodName	product
addOnModules.addOnModule	protocol
addOnModules.addOnModule	description
addOnModules.addOnModule.index	callingSearchSpaceName

Admin Portal

<input type="checkbox"/>	Name	Description
	Filter	Filter
<input type="checkbox"/>	AddCustomerAdmin_FDP	
<input type="checkbox"/>	AddSubscriberWizard_AdvDP_FDP	FDP for Extension Mobility step in Subscriber Wizard
<input type="checkbox"/>	AddSubscriberWizard_AdvLine_FDP	FDP for Advanced Line settings in Subscriber Wizard
<input type="checkbox"/>	AddSubscriberWizard_AdvPhone_FDP	FDP for Advanced Phone settings in Subscriber Wizard
<input type="checkbox"/>	AddSubscriberWizard_AdvPhoneRel_FDP	FDP for Advanced Phone settings in Subscriber Wizard using relation/Phc
<input type="checkbox"/>	AddSubscriberWizard_AdvRD_FDP	FDP for SNR (Destination) step in Subscriber Wizard
<input type="checkbox"/>	AddSubscriberWizard_AdvRDP_FDP	FDP for SNR (Profile) step in Subscriber Wizard
<input type="checkbox"/>	AddSubscriberWizard_AdvUser_FDP	FDP for Advanced User settings in Subscriber Wizard
<input type="checkbox"/>	AddSubscriberWizard_WizardSetup_FDP	FDP for Setup step in Subscriber Wizard
<input type="checkbox"/>	AdminUser	

The screenshot displays the configuration page for a Field Display Policy in the CS-P (Provider) system. The breadcrumb navigation indicates the path: Home / Field Display Policies / AddSubscriberWizard_AdvLine_FDP. The configuration details are as follows:

- Name ***: AddSubscriberWizard_AdvLine_FDP
- Description**: FDP for Advanced Line settings in Subscriber Wizard
- Target Model Type ***: device/cucm/Line

Below the configuration details, there is a 'Groups' section with a '+ Add' button. A 'Default' group is listed, and a 'No value set' group is highlighted in yellow. Underneath, there is a form with the following fields:

- Title ***: (Empty text input)
- Display as Fieldset**:
- Number of Columns**: (Empty text input)

The 'Fields' section is divided into two columns: 'Available' and 'Selected'. The 'Available' column contains the following fields:

- aarDestinationMask
- aarKeepCallHistory
- aarNeighborhoodName

Each field in the 'Available' column has a green arrow button to its right, used for moving the field to the 'Selected' column.

Business Admin Portal

The screenshot displays the Business Admin Portal for a provider named CS-P. The interface is organized into several key sections:

- Navigation Sidebar (Left):** A vertical green sidebar containing menu items such as Site Management, Number Inventory, Subscribers, Phones, Voicemail, Extension Mobility, Webex Teams, Contact Center Express, Hunt Groups, Call Pickup Groups, and Tools.
- Header (Top):** A green header bar with a back arrow, the provider name 'CS-P (Provider)', and utility icons for search, list, messages, and settings.
- Summary Cards (Main Content):** Three large blue cards with green accents showing key metrics: 'Sites 28', 'Subscribers 488', and 'Phones 1251'.
- Saved Searches:** A section indicating 'You don't have any searches saved.' with a refresh icon.
- Quick Actions:** A grid of actionable items including 'View Subscribers', 'Add Subscriber', 'View Phones', 'Add Phone', 'Reset Pin / Password', 'Login User / Phone', 'Logout Phone', and 'Line List'.
- Pre-Defined Searches:** A section with buttons for 'Line Search' and 'Numbers List'.

The screenshot displays a web application interface for 'CS-P (Provider)'. The main content area is titled 'Tools / Transaction Log' and contains a table with the following data:

ID	Action	Username	Status	
136546	Import Call Manager	system	Success	172.3
136544	Execute Schedule	system	Success	HcsC
136541	Import Call Manager	system	Success	172.3
136539	Execute Schedule	system	Success	HcsC
136538	Import Call Manager	system	Success	172.3
136536	Execute Schedule	system	Success	HcsC
136533	Import Call Manager	system	Success	172.3
136531	Execute Schedule	system	Success	HcsC
136530	Import Call Manager	system	Success	172.3
136528	Execute Schedule	system	Success	HcsC
136525	Import Call Manager	system	Success	172.3
136523	Execute Schedule	system	Success	HcsC
136522	Import Call Manager	system	Success	172.3
136520	Execute Schedule	system	Success	HcsC
136517	Import Call Manager	system	Success	172.3
136515	Execute Schedule	system	Success	HcsC
136514	Import Call Manager	system	Success	172.3

The interface also features a green sidebar with navigation options: Site Management, Number Inventory, Subscribers, Phones, Voicemail, Extension Mobility, Webex Teams, Contact Center Express, Hunt Groups, and Call Pickup Groups. The 'Tools' option is highlighted in yellow. The top header includes a search icon, a list icon, a notification icon with a '2' badge, a laptop icon, and a settings icon. The bottom of the table has a pagination bar with a blue background, showing page numbers 1, 2, 3, 4, 5 and a dropdown menu set to '200'.

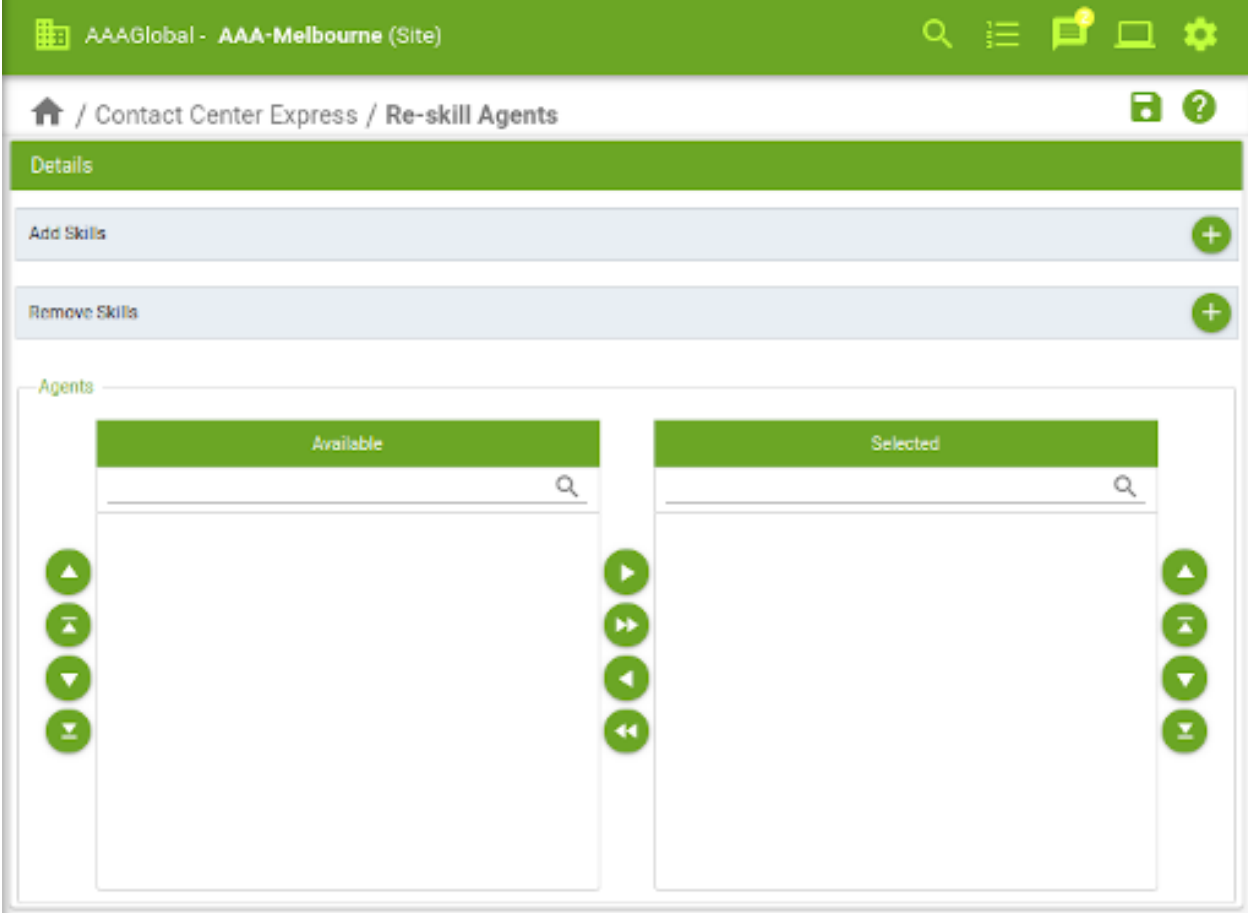

31. Appendix: Optional Features

31.1. Dial Plan Management

31.1.1. Configure the Dial Plan Management Menu Layout

1. Login as an administrator with sufficient rights to change menu layouts.
2. Click **Role Based Access > Menu Layouts**.
3. Select the required menu.
4. Configure the menu layout as shown below under **Dial Plan Management**.
5. Click **Save**.

Title	Type	Href	Display As
Dial Plan Management			List
Dial Plan Maintenance		/api/view/DP_MaintenanceVIEW/add	Form
Dial Plan Viewer	relation/DP_REL		List
Delete Dial Plan Model		/api/view/DP_DeleteDialPlanModel/add	Form
Dial Plan Input Data			List
• Global Data	data/DP_GlobalDialPlanData		List
• Site Level Data	ata/DP_SiteDialPlanData		List
Dial Plan Models			List
• Dial Plan Models	data/DP_DialPlan		List
• Device Pool-Region-Location-SRST	data/DP_DP-Reg-Loc		List
• Conference Bridge	data/DP_ConfBridge		List
• Media Resource Group List	data/DP_MediaResourceGroupList		List
• SIP Trunks	data/DP_SIPTrunk		List
• CTI Route Points	data/DP_CTIRoutePoint		List
• Route Groups	data/DP_RouteGroup		List
• Route Lists	data/DP_RouteList		List
• Route Patterns	data/DP_RoutePattern		List
• Translation Patterns	data/DP_TransPattern		List
• Called Party Transformations	data/DP_Called_Party_Transformation		List

Title	Type	Href	Display As
Dial Plan Models (Continued)			List
• Calling Party Transformations	data/DP_Calling_Party_Transformation		List
• SIP Route Patterns	data/DP_SIPRoutePattern		List
• Calling Space Search	data/DP_Css		List
• Transcoders	data/DP_Transcoder		List
• Time Periods	data/DP_TimePeriod		List
• Time Schedules	data/DP_TimeSchedule		List
• Media Resource Group	data/DP_MediaResourceGroup		List
• Partitions	data/DP_Partition		List
Dial Plan Log	data/DP_DialPlanLog		List

See also **Dial Plan Management Menu Layout** illustration:

	Title	Type	Href	Field Display Policy	Configuration Template	Display As	Filter Options	Menu Items
☰ ☱ ⏴	Dial Plan Maintenance		/api/view/DP_Maintenance			Form	More...	More...
☰ ⏴ ⏵	Dial Plan Viewer	relation/DP_REL				List	More...	More...
☰ ⏴ ⏵	Delete Dial Plan Model		/api/view/DP_DeleteDialPl			Form	More...	More...
☰ ⏴ ⏵	Dial Plan Input Data					List	More...	More...
☰ ⏴ ⏵	Dial Plan Models					List	More...	More...
☰ ⏴ ⏵	Dial Plan Log	data/DP_DialPlanLog				List	More...	More...

☰ Dial Plan Input Data
☰
☰
☰
☰
☰ List
More...
Less...

Menu Items

+ Menu Items

	Title	Type	Href	Field Display Policy	Configuration Template	Display As	Filter Options
☰ ☰ ☰	Global Data	data/DP_GlobalDialPlanDa				List	More...
☰ ☰ ☰	Site level Data	data/DP_SiteDialPlanData				List	More...

☰ Dial Plan Models
☰
☰
☰
☰
☰ List
More...
Less...

Menu Items

+ Menu Items

	Title	Type	Href	Field Display Policy	Configuration Template	Display As	Filter Options
☰ ☰ ☰	Dial Plan Models	data/DP_DialPlan				List	More...
☰ ☰ ☰	Device Pool - Region - Locatio	data/DP_DP-Reg-Loc				List	More...
☰ ☰ ☰	Conference Bridge	data/DP_ConfBridge				List	More...
☰ ☰ ☰	Media Resource Group List	data/DP_MediaResourceG				List	More...
☰ ☰ ☰	SIP Trunks	data/DP_SIPTrunk				List	More...
☰ ☰ ☰	CTI Route Points	data/DP_CTIRoutePoint				List	More...
☰ ☰ ☰	Route Groups	data/DP_RouteGroup				List	More...
☰ ☰ ☰	Route Lists	data/DP_RouteList				List	More...
☰ ☰ ☰	Route Patterns	data/DP_RoutePattern				List	More...
☰ ☰ ☰	Translation Patterns	data/DP_TransPattern				List	More...
☰ ☰ ☰	Called Party Transformations	data/DP_CalledParty_Tran				List	More...
☰ ☰ ☰	Calling Party Transformations	data/DP_CallingParty_Tran				List	More...
☰ ☰ ☰	SIP Route Patterns	data/DP_SIPRoutePattern				List	More...
☰ ☰ ☰	Calling Search Space	data/DP_Css				List	More...
☰ ☰ ☰	Transcoders	data/DP_Transcoder				List	More...
☰ ☰ ☰	Time Periods	data/DP_TimePeriod				List	More...
☰ ☰ ☰	Time Schedules	data/DP_TimeSchedule				List	More...
☰ ☰ ☰	Media Resource Group	data/DP_MediaResourceG				List	More...
☰ ☰ ☰	Partitions	data/DP_Partition				List	More...

31.1.2. Access Profile Changes

1. Login as an administrator with sufficient rights to change access profiles.
2. Click **Role Based Access > Access Profiles**.
3. Select the required administrator name, for example ProviderAdminAP.
4. Configure the provider access profiles as shown in step 5.
5. Under **Type Specific Permissions** add the following new **Permitted Type** entries and **Permitted Operations**:

- Permitted Type: view/DP_MaintenanceVIEW
- Permitted Operations: Create, Field Display Policy, Read
- Permitted Type: relation/DP_REL
- Permitted Operations: Create, Read
- Permitted Type: view/DP_DeleteDialPlanModel
- Permitted Operations: Create, Read
- Permitted Type: data/DP_GlobalDialPlanData
- Permitted Operations: Create, Delete, Export, Export Bulk Load, Read, Tag, Update
- Permitted Type: data/DP_SiteDialPlanData
- Permitted Operations: Create, Delete, Export, Export Bulk Load Template, Read, Tag, Update
- Permitted Types:
 - data/DP_CalledParty_Transformation
 - data/DP_CallingParty_Transformation
 - data/DP_ConfBridge
 - data/DP_Css
 - data/DP_CTIRoutePoint
 - data/DP_DialPlan
 - data/DP_DialPlanLog
 - data/DP_DP-Reg-Loc
 - data/DP_MediaResourceGroup
 - data/DP_MediaResourceGroupList
 - data/DP_Partition
 - data/DP_RouteGroup
 - data/DP_RouteList
 - data/DP_RoutePattern
 - data/DP_SIPRoutePattern
 - data/DP_SIPTrunk
 - data/DP_TimePeriod
 - data/DP_TimeSchedule
 - data/DP_Transcoder
 - data/DP_TransPattern
- Permitted Operations: Create, Delete, Export, Export Bulk Load Template, Read, Tag, Update

6. Click **Save**.

31.2. Unity SIP Integration

31.2.1. Configure the Unity SIP Integration Menu Layout

1. Login as an administrator with sufficient rights to change menu layouts.
2. Click **Role Based Access > Menu Layouts**.
3. Select the required menu.
4. Configure the menu layout as shown below under **Unity SIP Integration**.
5. Click **Save**.

Title	Type	Href	Display As
Unity SIP Integration			List
Integrate Unity-CallManager		/api/view/GlobalSIPVMIntegration/add	Form
Remove Integrate Unity-Call Manager		/api/view/GlobalSIPVMIntegrationDelete/add	Form
Dial Plan Profile	data/GlobalSIPVMDPPProfile		List
Integration Log	data/GlobalSIPVMLog		List
Unity Tenant Management			List
• Unity Tenant Add		/api/view/UnityTenantAdd/add	Form
• Unity Tenant Delete		/api/view/UnityTenantDelete/add	Form

See also **Unity SIP Integration Menu Layout** illustration:

Title	Type	Href	Field Display Policy	Configuration Template	Display As	Filter Options	Menu Items
Integrate Unity-CallManag		/api/view/GlobalSIPVMInte			Form	More...	More...
Remove Integrate Unity-Ci		/api/view/GlobalSIPVMInte			Form	More...	More...
Dial Plan Profile	data/GlobalSIPVMDPPri				List	More...	More...
Integration Log	data/GlobalSIPVMLog				List	More...	More...
Unity Tenant Management					List	More...	Less...

Title	Type	Href	Field Display Policy	Configuration Template	Display As	Filter Options
Unity Tenant Add		/api/View/UnityTenantAdd/ad			Form	More...
Unity Tenant Delete		/api/View/UnityTenantDelete/			Form	More...

31.2.2. Access Profile Changes

1. Login as an administrator with sufficient rights to change access profiles.
2. Click **Role Based Access > Access Profiles**.
3. Select the required administrator name, for example ProviderAdminAP.
4. Configure the provider access profiles as shown in step 5.
5. Under **Type Specific Permissions** add the following new **Permitted Type** entries and **Permitted Operations**:
 - Permitted Type: view/UnityTenantAdd
 - Permitted Operations: Create
 - Permitted Type: view/UnityTenantDelete
 - Permitted Operations: Create
 - Permitted Type: view/GlobalSIPVMIntegration
 - Permitted Operations: Create, Field Display Policy, Read, Tag
 - Permitted Type: view/GlobalSIPVMIntegrationDelete
 - Permitted Operations: Create
 - Permitted Type: data/GlobalSIPVMDPPProfile
 - Permitted Operations: Create, Delete, Read, Tag, Update
 - Permitted Type: data/GlobalSIPVMLog
 - Permitted Operations: Read, Tag
6. Click **Save**.

31.3. Phone Based Registration

31.3.1. Phone Based Registration

High level flow

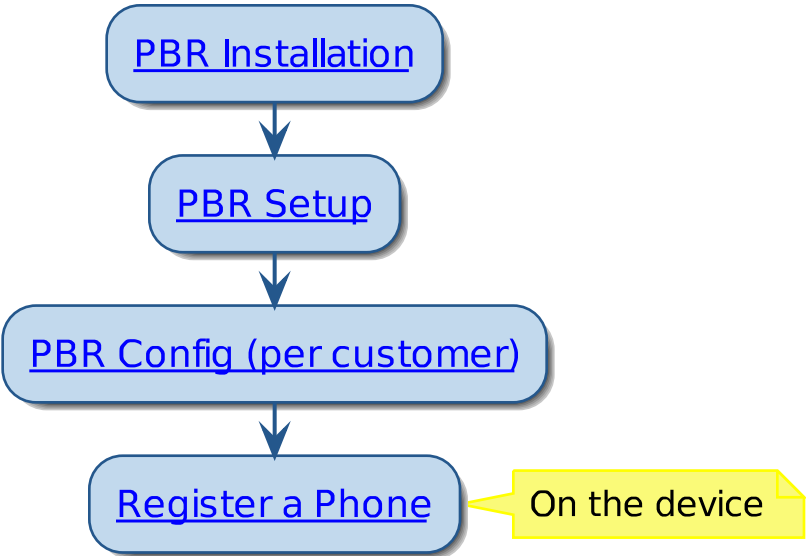

 Documentation: *Phone Based Registration: Overview*

PBR Installation

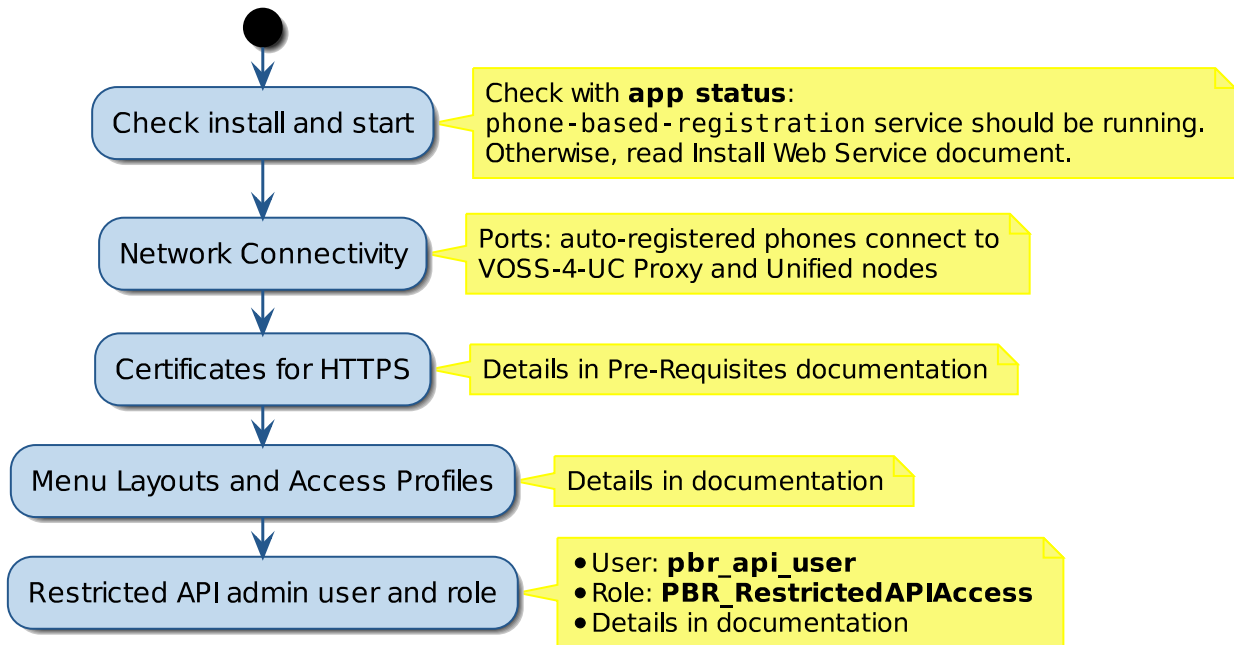

Documentation:

- *Pre-Requisites*
- *Install the Phone Based Registration Web Service*
- *Expose access to Phone Based Registration feature*
- *Create a restricted API Role and Admin user*
- *Menu Layout and Access Profiles*

PBR Setup

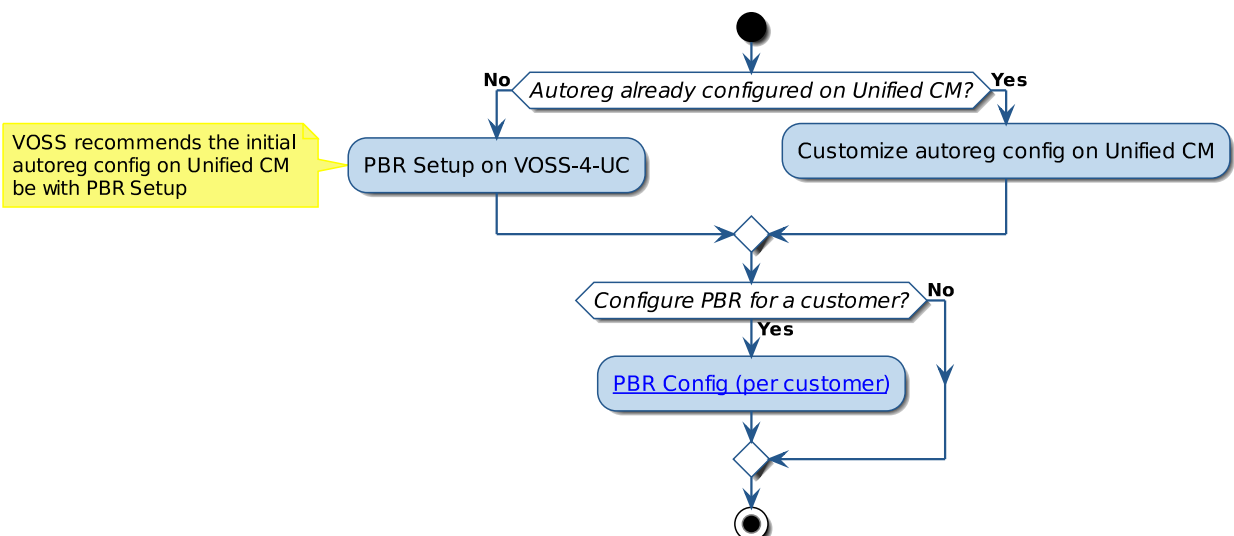



Documentation: [Configure a Cisco Unified CM for Phone Based Registration](#)

- When customizing Auto Registration on Unified CM, also refer [Configure a Cisco Unified CM for Phone Based Registration](#).



PBR Setup

PBR Config (per customer)

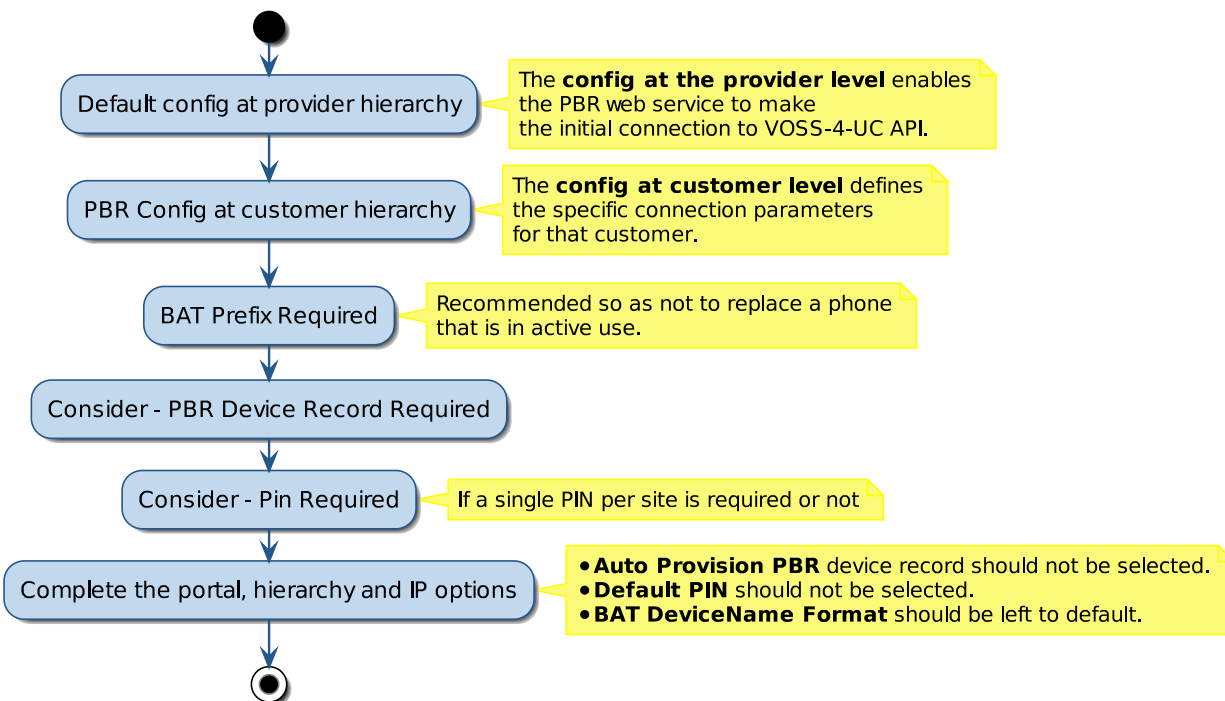

Documentation: [Configure the Phone Based Registration Add-On](#)



PBR Configuration

Register a Phone

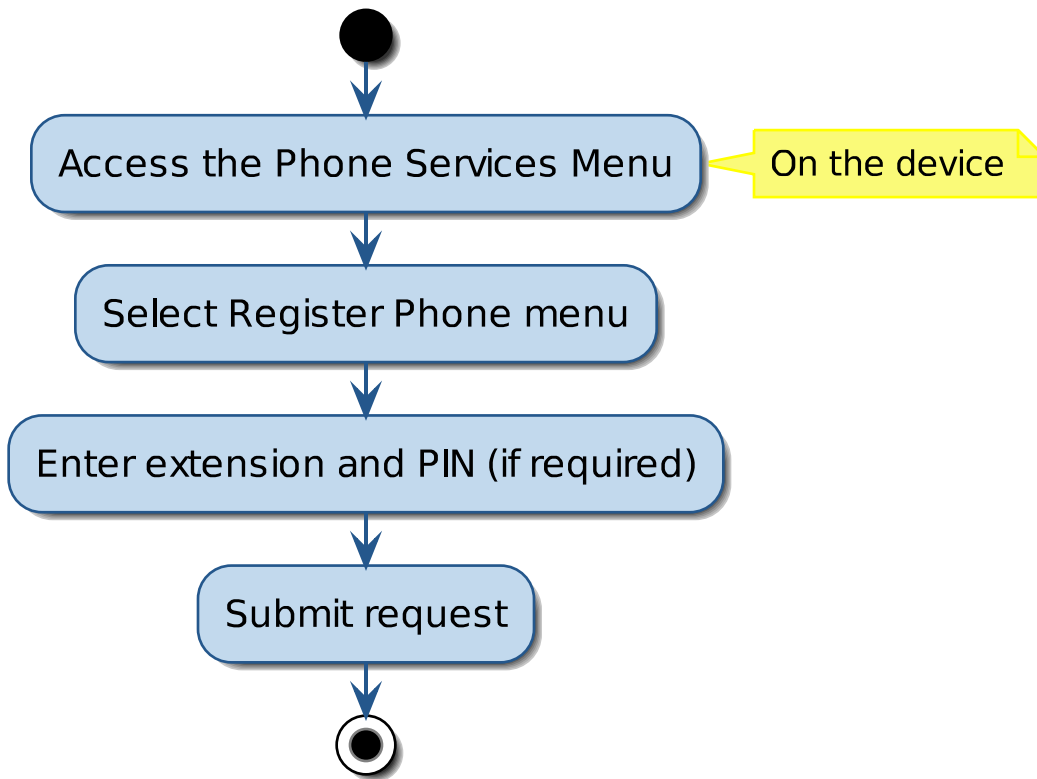

Documentation: [Detail Phone Based Provisioning Steps](#)



[Register a Phone](#)

31.3.2. Phone Based Registration: Overview

This document describes the installation, configuration, operation and troubleshooting procedures for the VOSS-4-UC Phone Based Registration Add-On.

The VOSS-4-UC Phone Based Registration Add-on feature allows an administrator to pre-provision Cisco Phones for UC Subscribers with rich and detailed configuration without requiring knowledge of the Phone MAC address in advance.

Given a pre-configured phone, the PBR Add-On allows an end user to access an Auto Registered phone to Register their pre-configured device via the Phone Services menus.

Phone Based Registration Feature Reference

- *Architecture*
- *Pre-Requisites*
- *Expose access to Phone Based Registration feature*
- *Create a restricted API Role and Admin user*
- *Install the Phone Based Registration Web Service*
- *Configure the Phone Based Registration Add-On*
- *Configure a Cisco Unified CM for Phone Based Registration*
- *High Level Overview of Phone Based Provisioning*

31.3.3. Architecture

Phone Based Registration Feature Reference

The VOSS-4-UC Phone Based Registration Add-on is implemented as a [Cisco Unified IP Phone Services Application](#).

This operates a web service on the VOSS-4-UC platform that is installed on all unified nodes in a VOSS-4-UC Cluster as follows:

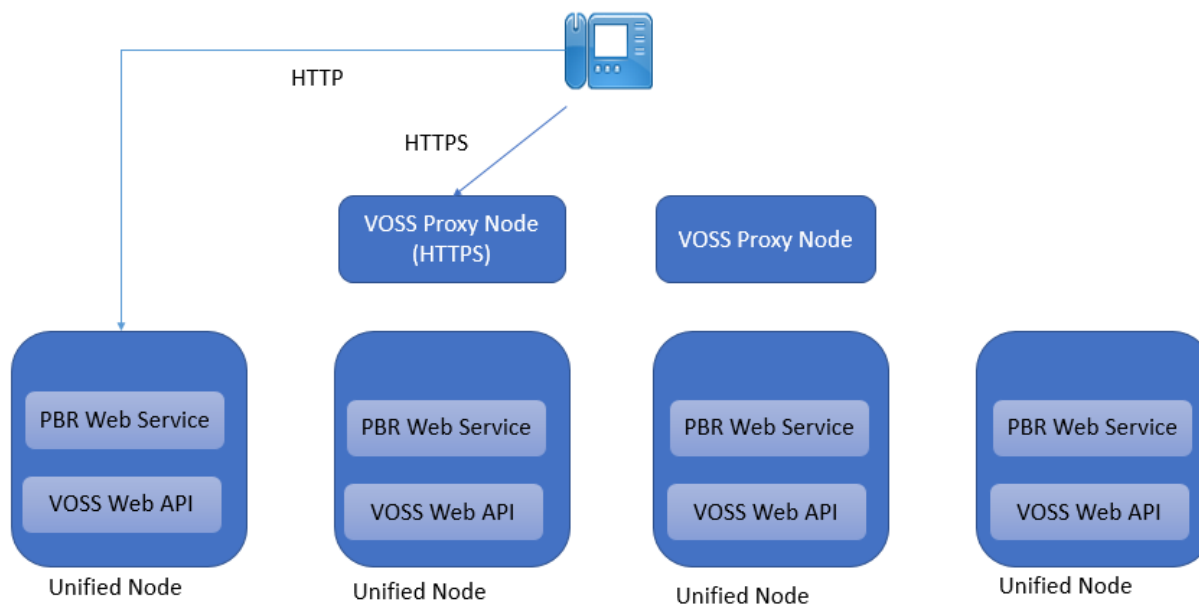

Figure 1: Phone Based Registration Network Connectivity

31.3.4. Pre-Requisites

Phone Based Registration Feature Reference

The following pre-requisites are required to install and operate the Phone Based Registration Add-On.

Network Connectivity

The VOSS-4-UC Phone Based Registration Add-On requires that Auto Registered Phones can connect to the VOSS-4-UC Proxy Nodes and Unified nodes.

Source Node	Destination Node	Transport	Port	Protocol
Phone	VOSS-4-UC Proxy Nodes	TCP	443	HTTPS
Phone	VOSS-4-UC Unified Nodes	TCP	8412	HTTP

Table 1: Phone Based Registration Network ports

Note that either HTTP or HTTPS is used on a per customer basis. The choice depends on:

- Security requirements, e.g. HTTPS only.
- Device support (some older devices do not support HTTPS – refer to the Cisco IP Phone security guide for list of devices that support secure communications).

Certificates for HTTPS

When using HTTPS for connectivity the VOSS-4-UC certificate must be installed on Cisco Call Managers that make use of the Phone Based Registration Service.

The VOSS-4-UC Platform certificate needs to be copied from the VOSS-4-UC server and uploaded to CUCM.

1. Log in to VOSS-4-UC using Firefox or Chrome. In the URL click on the 'Lock' symbol and choose to view the Certificate. Find the 'Copy To' or 'Export' option depending on your browser and save the certificate file to your PC.
2. Log in to VOSS-4-UC using the "Cisco Unified OS Administration" login. Browse to **Security > Certificate Management** and upload the Certificate with the Certificate Purpose set to 'tomcat-trust'. Restart the Cisco service as per the instructions.

The CUCM Hostname configured on CUCM under **System > Server** must be able to resolve via DNS otherwise the Phones will not authenticate. If the Hostname does not resolve then change the hostname to the IP Address instead.

31.3.5. Expose access to Phone Based Registration feature

Phone Based Registration Feature Reference

The Phone Based Registration Add-On needs to be added to the menu layouts for Provider and Customer administrators that require access to the feature.

The simplest mechanism to configure the menu layouts and access profiles for Phone Based Registration is to export the existing menu layouts and access profiles for the appropriate roles and submit to VOSS GS team to create a customized version that includes current modifications.

A detailed description of the items to expose can be found in *Menu Layout and Access Profiles*. 1.

► Subscriber Management	
Lines	
Agent Lines	
Phones	
Subscribers	► Phone-Based Registration*
Quick Add Subscriber	PBR Set-Up
Quick Add Subscriber Groups	PBR Config
Smart Add Phone	PBR phonereg IP Phone Service
Reset UC Passwords	PBR UDT Templates
Voicemail	PBR ULT Templates
WebEx	CUCM CallManagers
PLAR (Hotdial)	CUCM CallManager Groups
Hunt Groups	AutoRegistration Phone Protocol
Call Pickup Groups	
PBR Phones & PINs*	
PBR Register Phone**	Auto Reg Phones

Figure 2: Sample Menu layouts for Phone Based Registration Add-On

31.3.6. Create a restricted API Role and Admin user

Phone Based Registration Feature Reference

The Phone Based Registration Add-On Web service initiates transactions on behalf of the end user that is registering a phone. This requires a limited role to provide the least privilege to this user.

Create a Restricted API Access Role at the Provider Hierarchy

1. Browse to **Role Management**.
2. Click **Roles** and then **Add**.
3. Complete the form as follows:
 - a. Name: PBR_RestrictedAPIAccess
 - b. Menu Layout: RS_PBR_Restricted_Menu
 - c. Access Profile: RS_PBR_RestrictedAPIAccess

The screenshot shows a web interface for managing user roles. The title is "User Roles [PBR_RestrictedAPIAccess]". There are buttons for "Save", "Delete", "Help", "Back", and "Action". Below the title, there are tabs for "Base" and "Rules". The "Rules" tab is active, and it contains a form with the following fields:

Name*	PBR_RestrictedAPIAccess
Description	
Menu Layout	RS_PBR_Restricted_Menu
Theme	default
Access Profile*	RS_PBR_RestrictedAPIAccess
Interface*	Administration
Landing Page	
Self Service Links	

Figure 3: Sample Restricted API Access Role

Create a Restricted API Access User at the Provider Hierarchy

1. Browse to **Admin Users**.
2. Click **Add**.
3. Complete the form and select **PBR_RestrictedAPIAccess** for the role.
4. Note the email address and password.

Administration Users [pbr_api_user]		Save	Delete	Help	Back	Action ▼
Base	Account Information					
User Name*	<input type="text" value="pbr_api_user"/>					
Email Address	<input type="text" value="pbr_api_user@cc-p.com"/>					
First Name	<input type="text"/>					
Last Name	<input type="text"/>					
Password	<input type="password" value="*****"/>					
Repeat Password	<input type="password" value="*****"/>					
Role*	<input type="text" value="PBR_RestrictedAPIAccess"/>					
Language	<input type="text" value="English"/>					
Set by Default Language	<input checked="" type="checkbox"/>					

Figure 4: Sample Restricted API Access user

31.3.7. Install the Phone Based Registration Web Service

Phone Based Registration Feature Reference

Note that a full service restart is initiated on initial startup of the PBR web service on each VOSS-4-UC unified node.

- *On a cluster:*

1. On a *standard* topology, log in to *each node* serially and run `app install pbr`.

On a *scalable architecture* topology, log in to *each application node* serially and run `app install pbr`.

2. Verify that pbr is running: `app status`.

The output should contain `v21.1`, for example:

```
phone-based-registration v21.1 (2021-01-11 07:46)
|-nodeservice           running
```

- *On a standalone system:*

1. Log in to the unified node and run `app install pbr`.

2. Verify that pbr is running: `app status`.

The output should contain `v21.1`, for example:

```
phone-based-registration v21.1 (2021-01-11 07:46)
|-nodeservice           running
```

The PBR web service is assigned the same web weights as the `selfservice` and `voss-deviceapi` service. For example, when running **web weight list** from a web proxy, the output should be similar to the example below:

```

platform@VOSS-WP-1:~$ web weight list
Default service weights

upstreamservers:
  phonebasedreg:
    phoneservices:
      192.168.100.10:443: 0
      192.168.100.3:443: 1
      192.168.100.4:443: 1
      192.168.100.5:443: 1
      192.168.100.6:443: 1
      192.168.100.9:443: 0
    voss-deviceapi:
      selfservice:
        192.168.100.10:443: 0
        192.168.100.3:443: 1
        192.168.100.4:443: 1
        192.168.100.5:443: 1
        192.168.100.6:443: 1
        192.168.100.9:443: 0
      voss-deviceapi:
        192.168.100.10:443: 0
        192.168.100.3:443: 1
        192.168.100.4:443: 1
        192.168.100.5:443: 1
        192.168.100.6:443: 1
        192.168.100.9:443: 0

```

31.3.8. Configure the Phone Based Registration Add-On

Phone Based Registration Feature Reference

The Phone Based Registration Add-On supports a number of configuration parameters that manage how the service operates in a specific provider or customer environment. This configuration is implemented using the **Services > Phone Based Registration > PBR Config** menu item.

- A single PBR config record **MUST** be created globally at provider level.
- A PBR config record must be created for each customer that will utilize the phone based registration add-on.
- The config at the provider level is there to enable the PBR web service to make initial connection to VOSS-4-UC API.
- The config at customer level defines the specific connection parameters for that customer and eventually will allow per customer VOSS-4-UC user to be used.

Configuration is on VOSS-4-UC user interface:

Name	BAT Prefix Required	Auto Provision PBR	Pin Required	Hierarchy
Default	true		true	sys.hcs.CC-P
Default	true		true	sys.hcs.CC-P.FlexCorp
Default	true		true	sys.hcs.CC-P.AcmeCorp

Figure 5: Sample PBR Config record

When configuring the PBR service for a specific hierarchy the following considerations are important:

1. VOSS recommends that PBR configuration should only allow the replacement of phones with fake MACs with device name prefix starting with BAT.

This ensures that it is never possible for a user to replace a phone that is in active use.

Select the **BAT Prefix Required** check box.
2. Is the use of PBR Device records required in this environment?
 - a. The PBR device record provides a mechanism for administrators to explicitly specify that a device is eligible for phone based registration.

Select the **PBR Device Record Required** check box if this is desired.
 - b. The PBR device record allows the administrator to specify a PIN that should be used when performing phone based registration for a specific phone or for all phones at a site.

Select the **Pin Required** check box.

- c. The PBR device record can be used to guarantee that the correct device is replaced in environments where Directory numbers are not unique within a Unified CM cluster, e.g. multiple Directory numbers are configured with same DN but located in different partitions.

In this case, clear the **UseSiteWidePIN** check box.

Phone Registration Portal Port:

- This should be port 443 for HTTPS based connectivity
- This can be port 80 for HTTP based connectivity

Phone Registration Portal Address:

- When using HTTPS, this is the IP address or hostname of a VOSS-4-UC proxy node in a cluster.
- When using HTTP, this is the IP address or hostname of the primary VOSS-4-UC unified node in a cluster.
- This address and the port below must be accessible from the phone network.

Phone Registration Portal API User Credentials:

- Phone Registration Portal API User:
 - This is the user that was configured in the previous section of documentation. Please specify the email address.
- Phone Registration Portal API Password:
 - The password of the PBR API user:

Note that this information is required for both the Provider level config and the config for any customers.

Phone Registration Service Hierarchy:

- If the config record is defined at Provider level, then this should be the Provider hierarchy, e.g. sys.hcs.CC-P.
- If the config record is defined at the customer level, then this should be the customer hierarchy, e.g. sys.hcs.CC-P.FlexCorp)

CUCM IP:

- This should be the IP address of Unified CM that is accessible to VOSS-4-UC using HTTPS SOAP requests.

By default, VOSS-4-UC requires a PBR device record per device, but in some cases, it could be sufficient to use a single pin per site:

1. In this case, select the **UseSiteWidePIN** check box.
2. This provides limited security to ensure that a PIN is still required to register a phone, but reduces the operational burden by eliminating the need to provision a PBR device record for each phone.

Additional options:

- Auto Provision PBR device record. This feature is experimental and should **not be selected**.
- Use default PIN. This feature is experimental and should **not be selected**.
- BAT devicename format: This should be left to default.

Important: After saving the above configuration in VOSS-4-UC, you must restart the services by running the following CLI command on the primary node:

cluster run app start phone-based-registration

31.3.9. Configure a Cisco Unified CM for Phone Based Registration

Phone Based Registration Feature Reference

Using PBR Setup feature to configure a Cisco Unified CM

The PBR Setup feature automates the configuration of Unified CM for AutoRegistration and Phone Based Registration.

In VOSS-4-UC, browse to **Services > Phone Based Registration > PBR Setup**. The following input is required:

- **CUCM IP Address:** IP Address of the publisher for the Unified CM Cluster.
- **Call Manager Group for Auto Reg:** Name of Unified CM Group for AutoReg.
- **Call Manager for Auto Reg:** Name of the Call Manager for AutoReg (as specified under **Services > Phone Based Registration > CUCM Call Managers**).
- **First and Last Directory Number for Autoreg:** A valid range of DNs to be used for Auto Registration.
- **PBR Portal Address:** The IP Address of VOSS cluster UN1 .
- **PBR Portal Port:** 8412.

PBR Set-Up	
CUCM IP Address*	<input type="text" value="172.30.11.130"/>
Call Manager Group for Auto Reg*	<input type="text" value="Default"/>
Call Manager for Auto Reg*	<input type="text" value="172.30.11.130"/>
First Directory Number for auto registration *	<input type="text" value="8012000"/>
Last Directory Number for auto registration *	<input type="text" value="8012001"/>
Phone Registration Portal Address*	<input type="text" value="172.30.11.126"/>
Phone Registration Portal Port*	<input type="text" value="8412"/>

VOSS recommends that initial configuration of the Unified CM is performed using the PBR Setup workflow described above. In cases where there is existing auto registration config on the Unified CM, it may be required to do this manually.

Important: The **Services Provisioning** value under **Enterprise Parameters Configuration - Parameter Name** on the associated Unified CM **must** be set to **Both**.

Configuration on Cisco Unified CM

The VOSS-4-UC Phone Based Registration Add-On requires the following functionality to be configured on Cisco Unified CMs that manage phones which may be registered by this feature:

1. Configure the Unified CM to allow AutoRegistration of new phones. This is standard auto registration config for Unified CM. The PBR Setup in VOSS-4-UC carries out this configuration.
2. When a phone Auto Registers the `phonereg` phone service should be configured for the phone. This is achieved by specifying a Universal Device Template for Auto Reg that subscribes to the `phonereg` phone service.

Screenshots of the relevant configuration on Unified CM are provided to assist with understanding how the service is implemented and as background for a Cisco expert that may need to fine tune the Unified CM config.

3. Setup the `phonereg` Phone Service:

Browse to **Device > Device Settings > Phone Services**.

172.30.11.126

The screenshot shows the 'IP Phone Services Configuration' page for a service named 'phonereg'. The status is 'Ready'. The service is enabled and categorized as an 'XML Service' of type 'Standard IP Phone Service'. The service URL is configured as 'http://172.30.11.126:8412/phoneservices/172.30.11.130/phone'. The 'Service Parameter Information' section is currently empty, with buttons for 'New Parameter', 'Edit Parameter', and 'Delete Parameter'. At the bottom, there are buttons for 'Save', 'Delete', 'Update Subscriptions', and 'Add New'.

Service URL:

Depending on whether HTTPS or HTTP is used the service URL may be different:

- HTTP (Service URL):

```
http://{VOSS_IP}:{PBR_PORT}/phoneservices/{UnifiedCM_IP}/phonereg/menu?device=
↩️#DEVICENAME#
```

- HTTPS (Secure-Service URL):



```
https://{VOSS_IP}:443/phoneservices/{UnifiedCM_IP}/phonereg/menu?device=
↩️#DEVICENAME#
```

For HTTPS-only, both Secure Services URL and Service URL must be populated with the HTTPS URL.

Note: The port must always be specified explicitly.

4. Configure `phonereg` Universal Device Template:
 - a. Browse to **User Management > User/Phone Add > Universal Device** Template.
 - b. Note the subscription to the `phonereg` Phone Service.

Universal Device Template Configuration

 Save
 Delete
Expand All
 Add New

▼ **Template Information**

Name *

▼ **Required and Frequently Entered Settings**

Device Description

Device Pool * [View Details](#)

Device Security Profile *

SIP Profile *

Phone Button Template *

▶ Device Settings

▶ Device Routing



▶ Phone Settings

▶ Protocol Settings

▶ Phone Buttons Configuration

▼ **IP Phone Services Subscription**

Subscribe

Service	Description	Action
Register Phone	phonereg	 

5. Unified CM for Auto Registration:
 - a. Browse to **System > Cisco Unified CM**.
 - b. Note the `phonereg` Universal device template.

Cisco Unified CM Configuration

Save Reset Apply Config

Status

Info Status: Ready

Cisco Unified Communications Manager Information

Cisco Unified Communications Manager: CM_fx-pbr-cucm-01 (used by 17 devices)

Server Information

CTI ID: 1

Cisco Unified Communications Manager Server*: fx-pbr-cucm-01

Cisco Unified Communications Manager Name*:

Description:

Location Bandwidth Manager Group:

Auto-registration Information

Universal Device Template*:

Universal Line Template*:

Starting Directory Number*:

Ending Directory Number*:

Auto-registration Disabled on this Cisco Unified Communications Manager

Next Auto-Registration number to be used:

Note: Ensure there are unused Directory Numbers within the configured range.

31.3.10. High Level Overview of Phone Based Provisioning

Phone Based Registration Feature Reference

Setup a phone for Phone Based Registration

In this case we provision a phone with a fake MAC address, e.g. BAT000008012005 using bulk loaders or the VOSS-4-UC Admin portal. An optional Phone Based Registration (PBR) device record can be provisioned that provides the following functionality:

1. Configure a PIN code that can be used to authenticate requests to register phones with Phone Based Registration.
2. Assist with unique identification of device to replace where directory numbers are not unique within a Call Manager Cluster.

Register a phone with Phone Based Registration

Assuming the Phone is correctly setup the following steps are required to register a phone with the Phone Based Registration Add-On.

1. Auto Register a physical phone with Cisco Call Manager.
2. Access the Phone Services Menu on the Auto Registered Phone.
3. Select Register Phone menu option.
4. Enter extension and PIN (if required).
5. Submit request.

This initiates a request to VOSS-4-UC to replace the configuration of the Auto Registered Phone with the rich settings defined for the pre-provisioned device with fake MAC.

31.3.11. Detail Phone Based Provisioning Steps

1. Provision a phone with a fake MAC Address:
 - a. In this case we'll use Quick Add Subscriber, but VOSS-4-UC Phone Management or Advanced Subscriber features can also be used.
 - b. The fake MAC address must have a BAT prefix, e.g. BATABCABCABCABC.

Quick Add Subscriber Save Help Back Action ▾

Entitlement Profile: ["BasicUser", "hcs,CC-P"]

Quick Add Group*: Standard CIPC SIP

User status: Adding services to NEW CUCM user.

Lines

Directory Number*: 1008

Voice:

Phone Type: Cisco IP Communicator

Phone Protocol: SIP

Phones

Phone Name*: BATDONALDS

Extension Mobility:

Single Number Reach:

2. Provision a PBR Device Record for the phone with a PIN:
 - a. Browse to **Subscriber Management > PBR Phones and PINS > Add**.
 - b. Specify the Device Name of the pre-provisioned device with the fake MAC.
 - c. Route Partition is not required unless Site-Wide PIN.

PBR Phones & PINS* [BATDONALDS]

Device Name*: BATDONALDS

Pattern*: 1008

PIN: 12345

Route Partition:

3. Auto Register the Phone on CUCM:



4. Select Phone Services and then Register Phone:
 - a. Enter Extension and PIN.
 - b. Submit.



5. The Phone screen should now show Registering Phone.
6. The VOSS-4-UC Transaction log should now show a Register Phone Transaction.

Transaction					
Id	Action	Username	Status	Detail	Submitted Time
27354	Create Rs Reg Phone View	pbr_api_user	Success	RS_RegPhone_VIEW	January 16, 4:12:15 PM

Transaction		Replay	Help	Back
Status	Success			
Submitter Host Name	V4UCUCCEUCDMPRI			
Processor Host Name	V4UCUCCEUCDMPRI			
Message	Refresh device/cucm/User			
Rolled Back	No			
Priority	Normal			
Submitted Time	January 16, 2018 at 4:12:15 PM South Africa Standard Time			
Started Time	January 16, 2018 at 4:12:15 PM South Africa Standard Time			
Completed Time	January 16, 2018 at 4:12:21 PM South Africa Standard Time			
Duration	5.623 seconds			
Sub Transactions				
Action	Status	Transaction	Submitted Time	Detail
Update Cucm Phone	Success	Link	January 16, 4:12:19 PM	SEPDONALDS
Delete RS PBR Device	Success	Link	January 16, 4:12:18 PM	BATDONALDS

Note:

- The PBR Device Record is deleted (if you need to re-register this phone then a new record is required).
- The device name of the pre-provisioned phone (BATDONALDS) is updated to match the name of the autoregistered phone.

7. Upon completion of the transaction the phone should reboot and show the device configuration of the pre-provisioned phone.

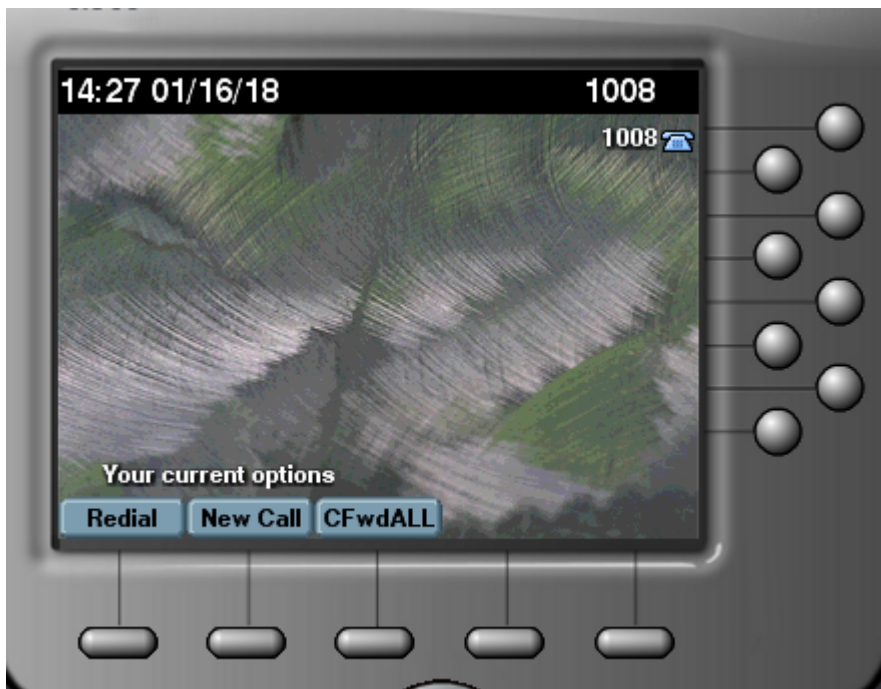

31.3.12. Provisioning PBR Device Records with Site Wide PINs

Site wide PINs are useful when PINs are required for either security or to address use-cases where DNs are not unique.

However, the operational overhead of provisioning a device record per unique device is not acceptable. In this case, create a single PBR device record at each site:

PBR Phones & PINs* [SITE]

Device Name*	<input type="text" value="SITE"/>
Pattern*	<input type="text" value="SITE"/>
PIN	<input type="text" value="12345"/>
Route Partition	<input type="text" value="Cu1S11-Feature-PT"/>

Note:

- When using Site wide PINs the Device Name and Pattern must be hardcoded to use SITE. This is case sensitive.
- When using Site wide PINs the administrator must specify the route partition for the site.

31.3.13. Menu Layout and Access Profiles

1. Phone-Based Registration Sub-menu under Services:

- Add “PBR Set-Up”
 - Title: PBR Set-Up
 - Type: view/RS_SetupReg_VIEW
 - Display As Form
- Add “PBR Config”
 - Title: PBR Config
 - Type: data/RS_PBR_Config
 - Display as list
- Add “PBR phonereg IP Phone Service”
 - Title: PBR phonereg IP Phone Service
 - Type: device/cucm/IpPhoneServices
- Add “PBR UDT Templates”
 - Title: PBR UDT Templates
 - Type: device/cucm/UniversalDeviceTemplate

- Add “PBR ULT Templates”
 - Title: PBR ULT Templates
 - Type: device/cucm/UniversalLineTemplate
- Add “CUCM CallManagers”
 - Title: CUCM CallManagers
 - Type: device/cucm/CallManager
- Add “CUCM CallManager Groups”
 - Title: CUCM CallManager Groups
 - Type: device/cucm/CallManagerGroup
- Add “AutoRegistration Phone Protocol”
 - Title: AutoRegistration Phone Protocol
 - Type: device/cucm/ServiceParameter
 - Filter: AutoRegistrationPhoneProtocol
 - * Filter By - Name
 - * Filter Type - Equals
 - * Filter String - AutoRegistrationPhoneProtocol
 - * Ignore Case - false
- Add “Auto Reg Phones”
 - Title: Auto Reg Phones
 - Type: relation/SubscriberPhone
 - Filter: Auto
 - * Filter By - BAT Phone Template
 - * Filter Type - Equals
 - * Filter String - Auto
 - * Ignore Case - false

2. Under Subscriber Management Advanced Functions add:

- Add “PBR Phones & PINs”
 - Type: data/RS_PBR_Device
 - Title: PBR Phones & PINs
- Add “PBR Register Phone”
 - Title: PBR Register Phone
 - Type: view/RS_RegPhone_VIEW
 - Display As: Form

3. Add the PBR Views to the Access Profile for Provider Admin (expose all operations):

- view/RS_RegPhone_VIEW
- view/RS_SetupReg_VIEW

- data/RS_PBR_Config
- data/RS_PBR_Device

31.4. Phone Services

31.4.1. Introduction to Phone Services

The Phone Services feature provides a XML-based interface to user settings that can be utilized via the Cisco IP Phones. If the feature is enabled, the following services become available for users to interact with via their IP Phones using the Telephone User Interface (TUI):

- Speed Dials - Provides the user with the ability to manage and use their speed dials for the phones/extension mobility profile.
- Call Forward - Provides the user with the ability to manage call forward destinations per line for key call forward options (all, busy, no answer).
- Corporate Directory - Provides the ability to view, search, and initiate calls from the users within VOSS-4-UC.

These will appear alongside other Phone Services that are setup in the system.

The Phone Service feature requires network connectivity between the phones and the VOSS-4-UC Proxy server instance. The feature supports HTTP only from the phones.

The Phone Services feature has been tested to support the following phone types:

- 78XX, 88XX, 89XX, and 99XX
- Other Cisco phone models may work, however these have not been validated and will not be supported if there are issues. So use with any other phone models should be tested carefully in your lab prior to use in production if desired.

See also:

- [Phone Services Feature Setup](#)
- [Manage Phone Services](#)

31.4.2. Phone Services Feature Setup

Introduction to Phone Services

To enable and setup Phone Services, the following steps are required:

1. Pre-requisites

Prior to setting up the Phone Services Feature, make sure that the phone based registration web service has already been installed, see [Install the Phone Based Registration Web Service](#).

2. Configure a Local Admin for use by the Feature

Configure a local admin user in the system at the provider level to be used by the Phone Services feature to initiate transactions in VOSS-4-UC. VOSS suggests this user is used just for phone services and not used to login to the system or for other admin purposes. The permissions required for this user are included in the access profile **RS_PBR_RestrictedAPIAccess**, which is on the system by default. You may need to create a role with the relevant settings to assign to the user being created. This user and password will be used in the next step.

Note: Consider a credential policy for this user that does not expire the password to avoid needing to change the password and update the various configurations setup in Step 3 for the new password.

3. Enable the PBR instance for UCM Clusters

If you have already configured Phone-based Registration then some of these steps might already be complete. Configuration parameters are accessed from the **Services > Phone Based Registration > PBR Config** menu item.

- Setup the required PBR Configuration instances in VOSS-4-UC. This may require you to add the correct model (**data/RS_PBR_Config**) to the access profile and menu layouts for the roles that require access to enable/configure phone services.
- An instance of the model at the Provider level is required (with the Unified CM IP value blank if you don't have a Unified CM at the Provider level). This instance will enable the basic Phone Services capability on the system.
- An instance of the model at the hierarchy level of the Unified CM Cluster that requires the feature to be supported. **In the case of a multi-cluster setup, multiple instances may be required at the same hierarchy (one instance per Unified CM).**

The following fields and settings are required for Phone Services (see also illustration below - values are examples only). The other settings on the form are not required for Phone Services.

- **Name** - Unique name for this instance.
- **Phone Registration Portal Address** - this is the IP address of the VOSS-4-UC Proxy that the phones will communicate with. This needs to be the address visible to the phones (could be across a NAT boundary).
- **Phone Registration Portal Port** - This must be port 8412.
- **Phone Registration Portal API User** - This user ID is hard coded for Phone Services: `pbr-api-access@[providername].com`.
- **Phone Registration Portal API Password** - The password for the user setup in Step 2.
- **Phone Registration Service Hierarchy** - This field is populated based on the hierarchy breadcrumb when you click the add button. If it is wrong, navigate back to the list view and change the breadcrumb to the correct hierarchy.
 - If the config record is defined at provider level, then this must be the provider hierarchy, for example `sys.hcs.CS-P`.

- If the config record is defined at the customer level, then this must be the customer hierarchy, for example `sys.hcs.CS-P.CS-NB.AAAGlobal`.
- **CUCM IP** - This should be the IP address of the Unified CM Publisher that is accessible to VOSS-4-UC using HTTP SOAP requests. Optional if this is the initial provider level record and there is not a Unified CM at that level.

The screenshot shows a configuration form with the following fields and values:

- Name* (circled in red): Default
- BAT Prefix Required*:
- BAT DeviceName Format:
- Auto Provision PBR*:
- Pin Required*:
- UseSiteWidePin*:
- PBR Device Record Required*:
- Phone Registration Portal Address (circled in red): 172.29.232.12
- Phone Registration Portal Port (circled in red): 8412
- Phone Registration Portal API User (circled in red): pbr-api-access@csp.com
- Phone Registration Portal API Password (circled in red):
- Repeat Phone Registration Portal API Password:
- Phone Registration service Hierarchy (circled in red): `sys.hcs.CS-P.CS-NB.AAAGlobal`
- CUCM IP (circled in red): 10.120.11.206

To make the setup of multiple instances of this record easier in a system with more than one cluster, you can include a configuration template in your menu layout populated with the values for the shared settings then the form will pre-populate with them, e.g. Portal address, Portal port, API User, and API Password.

Note: Depending on your network setup, in the event of a proxy failure, e.g. a data center DR Failover scenario, the Phone Services hostname/IP address may need to be changed to the proxy in the DR data center.

Important:

- After saving the above configuration in VOSS-4-UC, you must restart the services by running the following CLI command on the primary node (if not already done):

cluster run app start phone-based-registration

- The **Services Provisioning** value under **Enterprise Parameters Configuration - Parameter Name** on the associated Unified CM **must** be set to **Both**.

4. Create Unified CM IP Phone Service for Phones to Access the Feature

There are two ways of setting up the service that controls which devices the service appears on:

- Regular service - the service must be subscribed individually to specific phones on which the service must appear:

Enable check box = Selected

- Enterprise-wide subscription - the service will appear on all phones in the system:

Enterprise Subscription check box = Selected.

Typically an enterprise-wide subscription would be the easiest as it means not managing the service subscriptions by device. However, if more granular control is required then managing it as a normal service and subscribing as needed is possible.

The IP Phone Service provides the details of the VOSS-4-UC Service which is how the IP Phones access the feature. The service needs to be setup into the Unified CM for the phones to use it.

Choose **Device > Device Settings > Phone Services**.

The following are the settings for the service. The service can be configured via VOSS-4-UC if the IP Phone Services device model is included in your menus (or via bulk loader). Otherwise it can be configured directly in the Cisco Unified CM:

- **Service Name:** VOSS-4-UC Phone Services (or preferred name that will appear in the Phone's services menu)
- **Service Description:** VOSS-4-UC Phone Services
- **Service Category:** XML Service
- **Service Type:** Standard IP Phone Service
- **Service Vendor:** VOSS
- **ServiceURL:** Set the URL as follows (see Note below)

Note: This is an example ServiceURL only, showing the corporate directory format set to "UN-LN-FN" and the corporate directory scope set to "Customer". See parameters below, and replace the value following the '=' sign with the value you require.

```
http://<VOSS-4-UC-Address>:8412/phoneservices/<UnifiedCMAddress>/menu
?name=#DEVICENAME#
&corp_dir=true
&corp_dir_format=UN-LN-FN
&corp_dir_scope=Customer
&refresh=true
```

Where <VOSS-4-UC-Address> - is the address that the phones will use to reach VOSS-4-UC (typically the primary proxy server - consider any NAT setup in your network). You may consider using/validating a DNS SRV address here for redundancy in the event of a proxy failure. <UnifiedCMAddress> - is the address of Unified CM as known to VOSS-4-UC - consider any NAT setup in your network.

- `corp_dir` - this parameter is enabled (true) by default. It can be disabled if necessary by adding it to the URL as `corp_dir=false`. When enabled, the “Corp Dir” menu item is added to the list of services. The corporate directory shows the user with the number of the associated device at the selected hierarchy or lower (see `corp_dir_scope` below), and displays a maximum of 50 numbers only. The users are filtered and formatted according to the `corp_dir_format` parameter.

Note: The corporate directory excludes **End User** type users who have been marked “Exclude from Directory” as well as **Admin** type users (see [Add an Admin User](#)).

- `corp_dir_format` - this parameter determines the format of the corporate directory, and can have one of the following values:
 - “UN-LN-FN” = Username, Lastname, Firstname
 - “LN-FN-UN” = Lastname, Firstname, Username
 - “LN-FN” = Lastname, Firstname
 - “FN-LN” = Firstname, Lastname
 - “UN” = Username

If the parameter is omitted from the URL, the default corporate directory format will be “UN-LN-FN”, i.e. Username, Lastname, Firstname.

- `corp_dir_scope` - this parameter (either Provider, Reseller, Customer, IntermediateNode, Site, or LinkedSite) determines which users and numbers are displayed in the corporate directory. Default = Customer if a value is not specified.

The phone or device profile directory is used as a starting point, and then the search looks up the hierarchy for the `corp_dir_scope` value. For example, if set to Customer, the corporate directory will display users and numbers at the Customer hierarchy or lower.

If the phone or device profile number making the call is located at a higher hierarchy than the `corp_dir_scope` value, then VOSS-4-UC ignores the `corp_dir_scope` value and includes all users and numbers at the hierarchy of the phone or device profile number.

- `refresh` - this parameter is used to control whether the service will retrieve the latest setting from the underlying Unified CM when the service is used.

For example, when opening the call forward option, it would retrieve the latest call forward all setting from the Unified CM. This can be useful if the **CFWD ALL** softkey is also used on the phone. If the softkey is not being used and changes are only in VOSS-4-UC then `refresh=false` (which is the default if excluded) can be used to make the service quicker.

Note: To effect a change to any value on the IP Phone Services URL, you must click **Update Subscriptions** on the **IP Phone Services Configuration** page on the Unified CM.

IP Phone Services Configuration

 Save

- Status -

 Status: Ready

- Service Information -

Service Name*	<input type="text" value="Phone Services"/>
Service Description	<input type="text" value="Phone Services"/>
Service URL*	<input type="text" value="http://<VOSS-4-UC-Address>:8412/phoneservices/<UnifiedCM>"/>
Secure-Service URL	<input type="text"/>
Service Category*	<input type="text" value="XML Service"/>
Service Type*	<input type="text" value="Standard IP Phone Service"/>
Service Vendor	<input type="text" value="VOSS"/>
Service Version	<input type="text"/>

Enable
 Enterprise Subscription

 *- indicates required item.

5. Connectivity between Phones and VOSS-4-UC

For the Phone Services feature to work, the network needs to support connectivity between the Phones and the VOSS-4-UC Proxy server. This could be across a NAT boundary or a firewall that requires the appropriate configuration to allow the traffic. From a firewall perspective, the connectivity is via HTTP and the port is 8412. As noted above, consider the user/validating of a DNS SRV entry for the VOSS-4-UC proxy address for redundancy, otherwise if IP address or static hostname is used the service and rules may need updating in the event of a DR scenario or proxy failure.

See also:

- [Manage Phone Services](#)

31.4.3. Manage Phone Services

Note: This feature will only be available once correctly configured in VOSS-4-UC as well as the associated Unified CM (see [Phone Services Feature Setup](#)).

After initial configuration, an end user will be able to manage the following phone services directly from the phone (if configured in VOSS-4-UC):

- Speed Dials
- Call Forward - View Call Forward Settings, Set Call Fwd All(CFA), Set Call Fwd Busy(CFB), Set Call Forward NoAnswer(CFNA)
- Corporate Directory



Manage (add, edit or delete) a service directly from the Telephone User Interface (TUI).

The services all work in a similar way as shown in the following example with speed dials:

1. Select **Services > Speed Dial**.
2. Click **Manage**.
3. Click **Add**, **Edit** or **Delete** and follow the prompts.
4. Click **Submit** to initiate the transaction (only relevant to **Add** and **Edit**).

See also:

- [Introduction to Phone Services](#)
- [Phone Services Feature Setup](#)

Index

A

- app
 - app install list, [780](#)
 - app install pbr, [780](#)
 - app start phone-based-registration, [781](#)

C

- Call Park Management, [112](#)

F

- Feature
 - Forced Authorization Codes (*FAC*), [169](#)
 - Move Subscriber, [507](#)
 - Pexip Conferencing Overview, [573](#)
 - Phone Based Registration, [775](#)
 - Phone Registration Activation Code, [533](#)
 - Phone Services, [794](#)
 - Softkey Templates, [110](#)
 - User Management, [292](#)
 - Webex Teams, [574](#)

Flowchart

- Audit Number Inventory, [489](#)
- Number Cooling, [485](#)
- Number Inventory (*Enterprise*), [478](#)

- Forced Authorization Codes (*FAC*) (*Feature*), [169](#)

M

- Move Subscriber (*Feature*), [507](#)

P

- Pexip Conferencing Overview (*Feature*), [573](#)
- Phone Based Registration (*Feature*), [775](#)
- Phone Registration Activation Code (*Feature*), [533](#)
- Phone Services (*Feature*), [794](#)

Q

- Quick Add Subscriber (*Feature*)
 - Creating Quick Add Subscriber Groups, [553](#)

- Delete a Quick Add Subscriber Group, [553](#)
- Number Management, [484](#)
- Provision the Webex Teams Service, [560](#)
- Quick Add Subscriber Group, [522](#)
- Quick Add Subscriber Group Default Model, [522](#)
- Specify the Primary Line per Subscriber, [729](#)

S

- Softkey Templates (*Feature*), [110](#)

U

- User Management (*Feature*), [292](#)

W

- Webex Teams (*Feature*), [574](#)